

**PRECISION
TECHNOLOGY
INSIDE**



SUPER PRECISION BEARINGS



SUPER PRECISION BEARINGS

CONTENTS

Precision Technology Inside	P. 4
Bearing Tables	
Spindle Bearings	P. 8
Floating Displacement Bearings	P. 78
Super Precision Cylindrical Roller Bearings	P. 84
Double Direction Angular Contact Thrust Ball Bearings	P. 102
Angular Contact Thrust Ball Bearings for Ball Screws	P. 112
Axial-Radial Cylindrical Roller Bearings	P. 120
Engineering	
Life Calculation for Super Precision Bearings	P. 126
Lubrication	P. 135
Tolerances for Super Precision Bearings	P. 142
Machining Tolerances for Mating Parts	P. 154
Speed-Dependent Fits	P. 164
Speeds	P. 166
Deflection and Rigidity	P. 168
Handling of Super Precision Bearings	P. 170
Appendix	
<i>SpiCaS</i> 2000	P. 174
Other Products	P. 175
Bearing Code	P. 176
Notes	P. 200
Index	P. 201

Precision Technology Inside

P. 4

Spindle Bearings

P. 8

B719..C, B70..C, B72..C, HS70..C, HS719..C, B718..C

B719..E, B70..E, B72..E, HS70..E, HS719..E, B718..E

P. 12

Floating Displacement Bearings

P. 78

FD10

P. 80

Super Precision Cylindrical Roller Bearings

P. 84

N10, N19, HCN10

P. 86

NN30, NNU49

P. 94

Double Direction Angular Contact Thrust Ball Bearings

P. 102

2344, 2347

P. 104

Angular Contact Thrust Ball Bearings for Ball Screws

P. 112

7602, 7603, BSB

P. 114

Axial-Radial Cylindrical Roller Bearings

P. 120

RTC

P. 122

Engineering

P. 126

Appendix

P. 174

PRECISION TECHNOLOGY INSIDE

Optimum Customer Benefit

“Precision Technology Inside” of FAG AC/SP pursues one ultimate goal:

Optimum Customer Benefit.

There is far more to this concept than merely supplying specific products. It focuses on the application of FAG AC/SP super precision products – and thus on the customer. This focus is built on

- economic efficiency
- reliability
- innovation.

Being able to meet these claims requires continual contact with the customers, in order to learn about their demands and processes. This permits the selection of the most adequate product that will involve the lowest system costs. The solid basic research of FAG, its participation in university research projects and its worldwide operation lay the foundations for the development of new, reliable products and their use in new and demanding applications.

At first glance, the accuracy of bearings seems to be sufficiently defined in DIN/ISO or ABEC standards. Yet FAG super precision bearings go beyond this. In addition to demanding tolerances to P4 or better, there are other performance features that are not covered by these norms. FAG super precision bearings set standards wherever there are extreme demands in terms of reliability, high running accuracy and/or high speeds – whether incorporated in machine tools, auxiliary devices in the textile industry, woodworking machines or elsewhere. The comprehensive product range permits optimum bearing arrangements for all types of locations and applications. The performance of FAG super precision bearings in a specific application is achieved in particular through close co-operation with the customer. The higher and more complex the demands, the better the super precision bearing expertise will come to bear that has built up in FAG application engineering over the years. This catalogue provides a survey of the products and the most important rules for bearing selection and bearing arrangement design. For more detailed information, please do not hesitate to turn to our competent contact partners.

This is our contribution to a successful partnership.



FAG super precision bearings

FAG Super Precision Bearing Range • FAG X-life ultra



FAG X-life ultra bearings

FAG Super Precision Bearing Range

As machine tools are the main field of application for FAG super precision bearings, the super precision bearing range is built up in such a way that all machine tool locations requiring such bearings – spindles, ball screws, rotary tables – can be served. Thanks to the high performance standard of the existing product range, specific tailor-made solutions are rarely required. This is advantageous both in terms of bearing availability and stock-

keeping. In addition, special customer- or application-specific products are also developed whenever necessary.

FAG X-life ultra

The FAG X-life ultra bearing represents the top product among spindle bearings. In a virtually ideal way, it combines ceramic material and special rolling bearing steel with FAG bearing and application expertise to form a top-performance unit. X-life ultra bearings open up possibilities for maximum speeds and extended service life that offer both the machine or spindle manufacturer and the end user an enormous potential for system cost reduction.

PRECISION TECHNOLOGY INSIDE

Product Features of FAG Super Precision Bearings

Product Features of FAG Super Precision Bearings

Accuracy to P4S

All important product features of FAG super precision bearings meet Precision Class P2 (ABEC9). This applies to the dimensional and running accuracy as well as the parallelism of FAG bearings that are manufactured to FAG standard P4S.

Maximum precision spindle bearing arrangements can therefore be designed with standard FAG bearings. The experience gained with spindle bearings both in production and practical application has encouraged the transfer of this philosophy to other types of bearings. For instance, it also applies to FAG indexing table bearings that meet the demands of a higher precision class as standard for the most part.

Materials

FAG super precision bearings are manufactured from high-grade materials. Wear resistance and long material fatigue life up to fail-safety are achieved through a specific heat treatment procedure for steel materials. Among these, Cronidur 30 takes a special status. Its unique properties as to alternating bending strength and corrosion resistance result in significantly extended service life, higher admissible contact pressure for fail-safety, higher admissible speeds and significantly enhanced lubricant ser-



FAG RTC indexing table bearings



FAG hybrid bearings



FAG sealed bearings, lubricated for life

vice life. The standard for spindle bearings are hybrid bearings – a combination of steel rings and ceramic balls.

Cylindrical roller bearings also comprise ceramic rollers. Silicon nitride is the ceramic material that combines the typical ceramic properties in the most favourable way. Advantages compared to steel are

- the excellent tribological behaviour of steel and ceramics in hybrid bearings, resulting in reduced material and lubricant stress.
- the reduced density with correspondingly lower centrifugal forces.
- the lower thermal expansion coefficient with its positive effect on bearing preload.
- the higher elastic-modulus that has a positive influence on bearing rigidity

These factors result in significantly extended bearing life. For this reason, hybrid bearings are meanwhile commonly used even with lower speeds.

Lubrication

The lubricant plays a decisive role in the overall consideration of the system 'bearing' as the decision in favour of either oil or grease has an immense influence on system costs. Super precision bearings and FAG AC/SP lubricants permit reliable grease lubrication even at maximum speeds. Before a lubricant is approved for such applications, it has to undergo a strict approval procedure. Here, application-specific demands play a crucial role, for instance high speeds, low temperatures and non-critical

run-in behaviour in the case of spindles. The final result is a special product definition for which compliance is ensured by continuous inspections.

SPINDLE BEARINGS



FAG spindle bearings are single row angular contact ball bearings of the highest precision. Their special design features in terms of contact geometry, surface design and other properties result in

- high precision
- excellent speed-ability
- high rigidity
- good vibration behaviour of the spindles.

The bearings are available in various standardized boundary dimensions which represent an important

prerequisite for bearing exchangeability. This permits optimum solutions for specific demands.

FAG Universal Bearings

FAG universal bearings are a speciality. They are manufactured in such a way that they can be mounted in any arrangement without suffering performance losses or combined in different sets. This brings essential logistical advantages, especially in stock-keeping of spare parts. The bearings can be arranged according to the symbol on the outer ring surface (Picture 1).

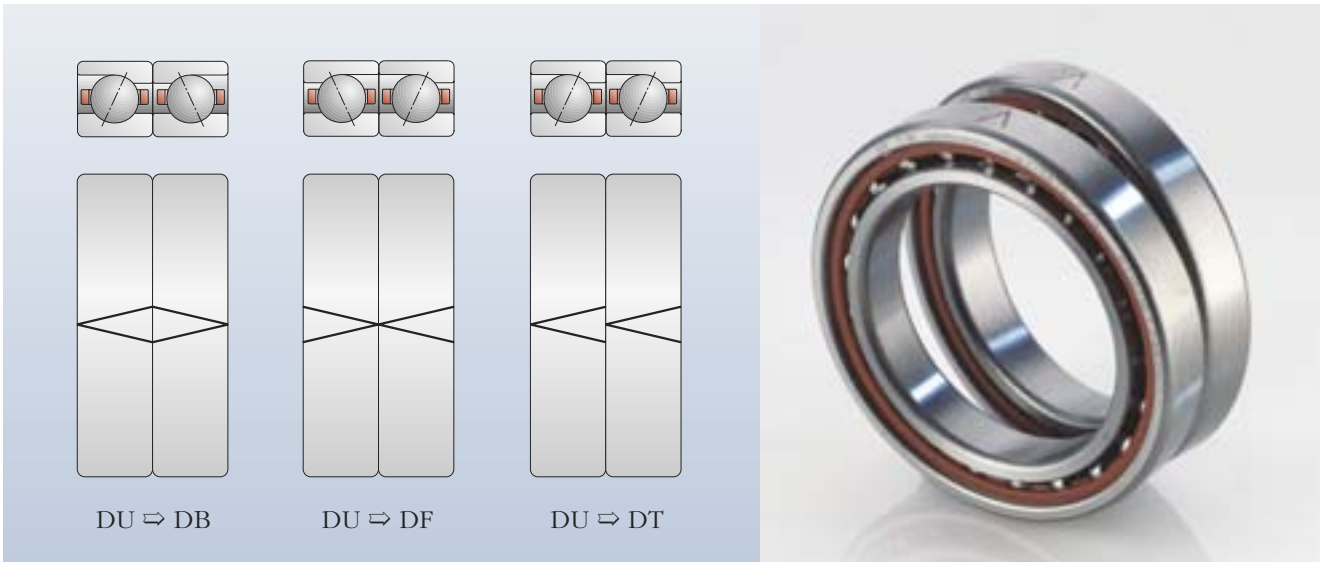
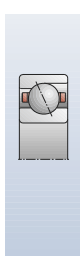

1: Installation possibilities of a DU set

Sealed Spindle Bearings

Thanks to sealed spindle bearings, it has been possible to convert an even wider field of applications to grease lubrication. These bearings are filled with heavy-duty FAG grease Arcanol L75 and fitted with non-contact seals at both sides. Based on the experiences gained with sealed high-speed spindle bearings, other spindle bearing series were also designed in a sealed version so that the following advantages

- ready-to-mount
 - filled with optimum grease in the appropriate quantity
 - protected against contamination
- are now available throughout the entire bearing range (Picture 2).



2: Sealed spindle bearings

SPINDLE BEARINGS

DIRECT LUBE Bearings

Where grease lubrication meets its limits, DIRECT LUBE bearings complement the spindle bearing range in a virtually ideal way. DIRECT LUBE bearings ensure reliable lubricant feed very close to the point of contact. This is achieved by a circumferential groove and radial supply holes. Integral precision O-rings seal the bearing against the spindle housing. Thanks to this special design, the high performance is coupled with a reduction of the overall bearing system costs (Picture 3).

Hybrid Bearings

Hybrid bearings – rings of steel and balls of ceramic material – are most commonly used for spindle bearings. Originally only to be found in the high-speed sector, they are meanwhile also used with significantly lower speeds. The reasons for this trend are

- their robustness and reliability
- their significantly extended service life

Hybrid bearings were an important prerequisite for the extended use of grease lubrication. In this connection they are a further factor for the reduction of system costs.



3: DIRECT LUBE bearing

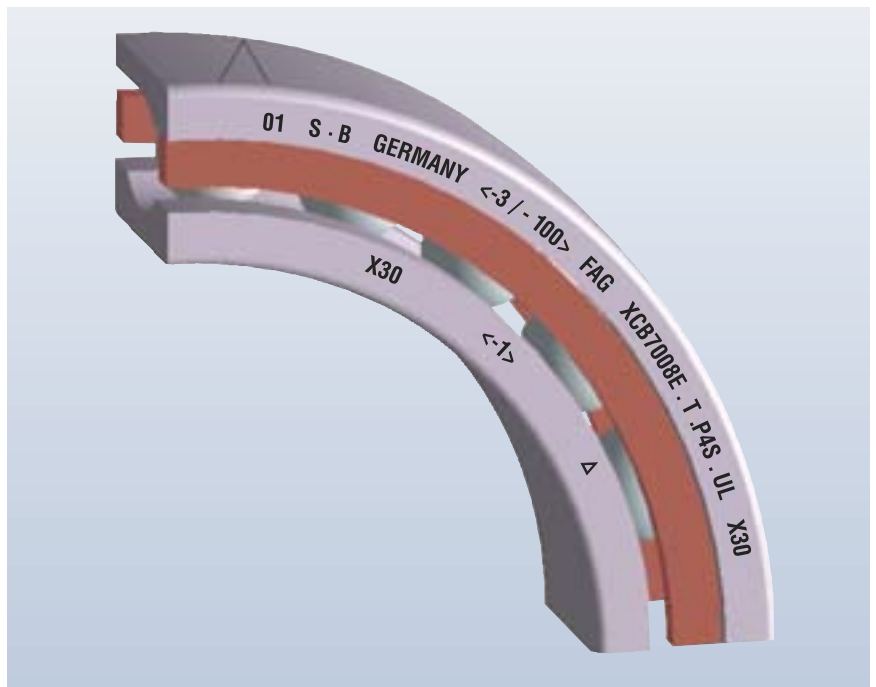

4: Bearing code



X-life ultra Bearings

X-life ultra bearings were designed for maximum demands on speed-ability and load. They are hybrid bearings with rolling bearing rings made of Cronidur 30, a high nitrogen stainless steel. Compared to the conventional rolling bearing steel 100Cr6, Cronidur 30 exhibits a substantially finer structure, thus ensuring cooler operation and higher admissible contact pressure. Basically, all spindle bearing designs are available as X-life ultra bearings.

Compared to standard bearings, the extended service life of X-life ultra bearings contributes to the reduction of system costs. However, achieving the full performance capability of X-life ultra bearings requires a corresponding design of the surrounding structure (Picture 5).



5: X-life ultra bearings

Spindle Bearing Code

All spindle bearings show a uniform code (Picture 4). In addition to the information about the bearing designation this includes important information on

- the tolerance of inner ring bore and outside diameter
- the bearing width. This is a **new** piece of information.
- the mounting direction, through marking on outer ring surface.

This information offers the installation engineer support for a well-

aimed matching of bearings and shaft or housing.

Details on the bearing code can be derived from the nomenclature (spindle bearings) in the appendix.

SPINDLE BEARINGS

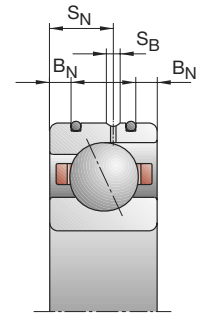
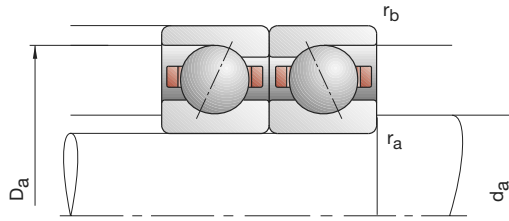
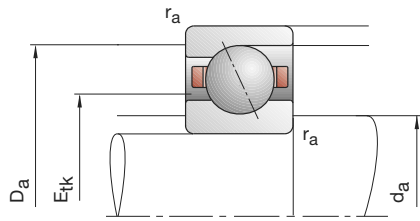

Bearing Code	Dimensions					Abutment Dimensions				DLR Dimensions			Load Ratings		
	d	D	B	r _{smin}	r _{1smin}	d _a h12	D _a H12	r _a max	r _b max	B _N	S _N	S _B	E _{tk}	C _{dyn}	C _{0stat}
FAG	mm													kN	
B706C.T.P4S	6	17	6	0.30	0.30	8.5	14.5	0.3	0.1				10.5	2.36	0.97
B706E.T.P4S	6	17	6	0.30	0.30	8.5	14.5	0.3	0.1				10.5	2.28	0.93
HCB706C.T.P4S	6	17	6	0.30	0.30	8.5	14.5	0.3	0.1				10.5	1.63	0.67
HCB706E.T.P4S	6	17	6	0.30	0.30	8.5	14.5	0.3	0.1				10.5	1.56	0.66
XCB706C.T.P4S	6	17	6	0.30	0.30	8.5	14.5	0.3	0.1				10.5	3.65	0.67
XCB706E.T.P4S	6	17	6	0.30	0.30	8.5	14.5	0.3	0.1				10.5	3.45	0.66
HS706C.T.P4S	6	17	6	0.30	0.30	8.5	14.5	0.3	0.1				10.5	1.56	0.70
HS706E.T.P4S	6	17	6	0.30	0.30	8.5	14.5	0.3	0.1				10.5	1.50	0.66
HC706C.T.P4S	6	17	6	0.30	0.30	8.5	14.5	0.3	0.1				10.5	1.08	0.48
HC706E.T.P4S	6	17	6	0.30	0.30	8.5	14.5	0.3	0.1				10.5	1.04	0.46
XC706C.T.P4S	6	17	6	0.30	0.30	8.5	14.5	0.3	0.1				10.5	2.40	0.48
XC706E.T.P4S	6	17	6	0.30	0.30	8.5	14.5	0.3	0.1				10.5	2.32	0.46
B707C.T.P4S	7	19	6	0.30	0.30	10	16	0.3	0.1				12.0	2.60	1.14
B707E.T.P4S	7	19	6	0.30	0.30	10	16	0.3	0.1				12.0	2.50	1.10
HCB707C.T.P4S	7	19	6	0.30	0.30	10	16	0.3	0.1				12.0	1.80	0.80
HCB707E.T.P4S	7	19	6	0.30	0.30	10	16	0.3	0.1				12.0	1.73	0.77
XCB707C.T.P4S	7	19	6	0.30	0.30	10	16	0.3	0.1				12.0	4.05	0.80
XCB707E.T.P4S	7	19	6	0.30	0.30	10	16	0.3	0.1				12.0	3.90	0.77
HS707C.T.P4S	7	19	6	0.30	0.30	10	16	0.3	0.1				12.0	1.70	0.80
HS707E.T.P4S	7	19	6	0.30	0.30	10	16	0.3	0.1				12.0	1.60	0.77
HC707C.T.P4S	7	19	6	0.30	0.30	10	16	0.3	0.1				12.0	1.16	0.55
HC707E.T.P4S	7	19	6	0.30	0.30	10	16	0.3	0.1				12.0	1.10	0.53
XC707C.T.P4S	7	19	6	0.30	0.30	10	16	0.3	0.1				12.0	2.60	0.55
XC707E.T.P4S	7	19	6	0.30	0.30	10	16	0.3	0.1				12.0	2.45	0.53
Designation examples:															
						Sealed design									
						HSS706E.T.P4S.UL									
											Hybrid ceramic design				
											HCB706C.T.P4S.UL				

SPINDLE BEARINGS

B718..C/E, B719, B70, B72 HS719..C/E, HS70

C: Contact Angle $\alpha = 15^\circ$ / E: Contact Angle $\alpha = 25^\circ$

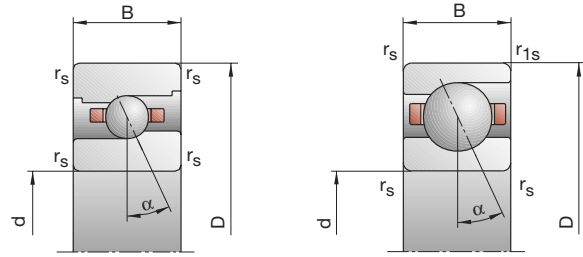

6 - 7

Attainable Speed	Preloading Force			Unloading Force			Axial Rigidity			Sealed Design	Weight	Bearing Code	
	Grease	Oil minimal	F_V	K_{aE}	S_a	L	M	H	L				M
min ⁻¹		N						N/ μ m			kg	FAG	
95000	160000	9	34	77	28	119	294	8.6	16.4	25.5	–	0.005	B706C.T.P4S
85000	140000	14	60	132	42	187	429	20.9	36.5	51.4	–	0.005	B706E.T.P4S
120000	190000	5	17	39	15	56	138	7.5	13.0	19.5	–	0.004	HCB706C.T.P4S
100000	170000	5	28	67	15	85	211	16.5	30.3	43.0	–	0.004	HCB706E.T.P4S
160000	260000	5	17	39	15	56	138	7.5	13.0	19.5	–	0.004	XCB706C.T.P4S
130000	200000	5	28	67	15	85	211	16.5	30.3	43.0	–	0.004	XCB706E.T.P4S
120000	190000	5	16	31	15	52	108	6.2	10.5	14.7	•	0.010	HS706C.T.P4S
100000	170000	8	25	51	23	75	157	15.3	23.8	31.6	•	0.010	HS706E.T.P4S
140000	220000	4	11	21	12	35	70	6.4	9.9	13.3	•	0.010	HC706C.T.P4S
120000	190000	6	18	35	18	54	107	16.2	23.7	30.6	•	0.010	HC706E.T.P4S
180000	300000	4	11	21	12	35	70	6.4	9.9	13.3	•	0.010	XC706C.T.P4S
160000	260000	6	18	35	18	54	107	16.2	23.7	30.6	•	0.010	XC706E.T.P4S
85000	140000	9	38	85	28	133	324	9.3	18.4	28.4	–	0.008	B707C.T.P4S
75000	120000	16	65	145	47	202	470	23.2	40.4	57.1	–	0.008	B707E.T.P4S
110000	180000	5	18	43	15	59	152	8.1	14.2	21.7	–	0.007	HCB707C.T.P4S
95000	160000	5	30	73	15	91	228	17.8	33.5	47.5	–	0.007	HCB707E.T.P4S
150000	240000	5	18	43	15	59	152	8.1	14.2	21.7	–	0.007	XCB707C.T.P4S
120000	190000	5	30	73	15	91	228	17.8	33.5	47.5	–	0.007	XCB707E.T.P4S
110000	180000	6	17	34	18	55	118	7.1	11.4	16.2	•	0.010	HS707C.T.P4S
90000	150000	9	27	54	26	81	166	17.2	26.1	34.4	•	0.010	HS707E.T.P4S
120000	190000	4	12	23	12	38	77	6.9	10.9	14.8	•	0.010	HC707C.T.P4S
110000	180000	6	19	37	18	57	112	17.4	25.9	33.1	•	0.010	HC707E.T.P4S
160000	260000	4	12	23	12	38	77	6.9	10.9	14.8	•	0.010	XC707C.T.P4S
140000	220000	6	19	37	18	57	112	17.4	25.9	33.1	•	0.010	XC707E.T.P4S

X-life ultra design
XC706E.T.P4S.UL
XCB706C.T.P4S.UL

See Bearing Code, page 178

SPINDLE BEARINGS

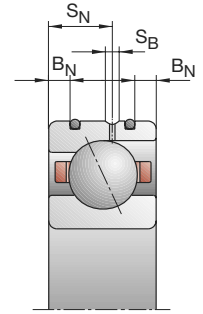
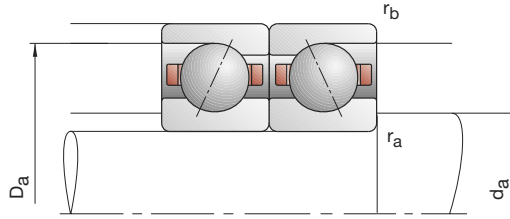
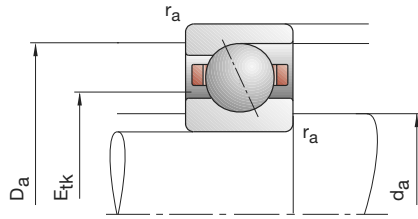

Bearing Code	Dimensions					Abutment Dimensions				DLR Dimensions			Load Ratings		
	d	D	B	r _{smin}	r _{1smin}	d _a h12	D _a H12	r _a max	r _b max	B _N	S _N	S _B	E _{tk}	C _{dyn}	C _{0stat}
FAG	mm													kN	
B708C.T.P4S	8	22	7	0.30	0.30	11	19	0.3	0.1				14.0	3.80	1.73
B708E.T.P4S	8	22	7	0.30	0.30	11	19	0.3	0.1				14.0	3.75	1.66
HCB708C.T.P4S	8	22	7	0.30	0.30	11	19	0.3	0.1				14.0	2.65	1.20
HCB708E.T.P4S	8	22	7	0.30	0.30	11	19	0.3	0.1				14.0	2.55	1.16
XCB708C.T.P4S	8	22	7	0.30	0.30	11	19	0.3	0.1				14.0	6.00	1.20
XCB708E.T.P4S	8	22	7	0.30	0.30	11	19	0.3	0.1				14.0	5.70	1.16
HS708C.T.P4S	8	22	7	0.30	0.30	11	19	0.3	0.1				14.0	1.90	1.00
HS708E.T.P4S	8	22	7	0.30	0.30	11	19	0.3	0.1				14.0	1.80	0.95
HC708C.T.P4S	8	22	7	0.30	0.30	11	19	0.3	0.1				14.0	1.29	0.70
HC708E.T.P4S	8	22	7	0.30	0.30	11	19	0.3	0.1				14.0	1.22	0.66
XC708C.T.P4S	8	22	7	0.30	0.30	11	19	0.3	0.1				14.0	2.90	0.70
XC708E.T.P4S	8	22	7	0.30	0.30	11	19	0.3	0.1				14.0	2.70	0.66
B709C.T.P4S	9	24	7	0.30	0.30	12	21	0.3	0.1				15.3	5.20	2.40
B709E.T.P4S	9	24	7	0.30	0.30	12	21	0.3	0.1				15.3	5.10	2.32
HCB709C.T.P4S	9	24	7	0.30	0.30	12	21	0.3	0.1				15.3	3.60	1.66
HCB709E.T.P4S	9	24	7	0.30	0.30	12	21	0.3	0.1				15.3	3.45	1.60
XCB709C.T.P4S	9	24	7	0.30	0.30	12	21	0.3	0.1				15.3	8.00	1.66
XCB709E.T.P4S	9	24	7	0.30	0.30	12	21	0.3	0.1				15.3	7.65	1.60
HS709C.T.P4S	9	24	7	0.30	0.30	12	21	0.3	0.1				15.3	2.65	1.43
HS709E.T.P4S	9	24	7	0.30	0.30	12	21	0.3	0.1				15.3	2.50	1.37
HC709C.T.P4S	9	24	7	0.30	0.30	12	21	0.3	0.1				15.3	1.83	1.00
HC709E.T.P4S	9	24	7	0.30	0.30	12	21	0.3	0.1				15.3	1.73	0.95
XC709C.T.P4S	9	24	7	0.30	0.30	12	21	0.3	0.1				15.3	4.05	1.00
XC709E.T.P4S	9	24	7	0.30	0.30	12	21	0.3	0.1				15.3	3.90	0.95
Designation examples:															
						Sealed design									
						HSS708E.T.P4S.UL									
											Hybrid ceramic design				
											HCB708C.T.P4S.UL				

SPINDLE BEARINGS

B718..C/E, B719, B70, B72 HS719..C/E, HS70

C: Contact Angle $\alpha = 15^\circ$ / E: Contact Angle $\alpha = 25^\circ$

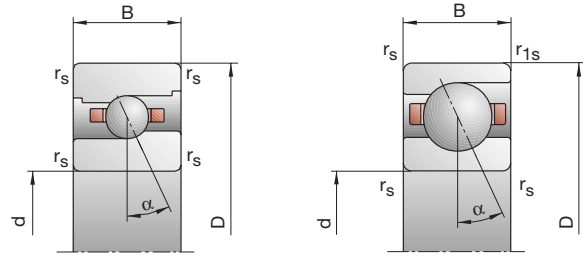

8 - 9

Attainable Speed	Grease	Oil minimal	Preloading Force F_V			Unloading Force K_{aE}			Axial Rigidity S_a			Sealed Design	Weight	Bearing Code
			L	M	H	L	M	H	L	M	H			
min ⁻¹			N			N/μm			kg				FAG	
75000	120000	15	59	129	47	206	490	12.0	22.9	34.9	–	0.010	B708C.T.P4S	
67000	100000	19	90	207	56	277	668	26.4	47.9	68.6	–	0.010	B708E.T.P4S	
95000	160000	6	29	66	18	95	232	9.2	18.0	26.8	–	0.009	HCB708C.T.P4S	
80000	130000	10	39	100	29	118	312	23.4	39.1	56.5	–	0.009	HCB708E.T.P4S	
120000	190000	6	29	66	18	95	232	9.2	18.0	26.8	–	0.009	XCB708C.T.P4S	
100000	170000	10	39	100	29	118	312	23.4	39.1	56.5	–	0.009	XCB708E.T.P4S	
95000	160000	6	19	38	18	62	131	8.0	13.4	18.7	•	0.010	HS708C.T.P4S	
80000	130000	10	30	61	29	89	187	20.1	30.2	40.3	•	0.010	HS708E.T.P4S	
110000	180000	4	13	26	12	41	87	7.7	12.5	17.3	•	0.010	HC708C.T.P4S	
90000	150000	7	21	42	20	62	127	19.7	29.7	38.9	•	0.010	HC708E.T.P4S	
140000	220000	4	13	26	12	41	87	7.7	12.5	17.3	•	0.010	XC708C.T.P4S	
120000	190000	7	21	42	20	62	127	19.7	29.7	38.9	•	0.010	XC708E.T.P4S	
67000	100000	23	85	181	72	293	676	14.4	26.5	39.6	–	0.015	B709C.T.P4S	
60000	90000	31	131	292	91	401	930	32.4	56.3	79.0	–	0.015	B709E.T.P4S	
85000	140000	8	39	90	24	127	311	10.6	20.5	30.2	–	0.013	HCB709C.T.P4S	
75000	120000	15	56	137	44	168	423	28.3	45.7	64.6	–	0.013	HCB709E.T.P4S	
110000	180000	8	39	90	24	127	311	10.6	20.5	30.2	–	0.013	XCB709C.T.P4S	
100000	170000	15	56	137	44	168	423	28.3	45.7	64.6	–	0.013	XCB709E.T.P4S	
85000	140000	9	26	53	27	84	181	10.2	16.3	22.9	•	0.020	HS709C.T.P4S	
75000	120000	14	43	86	41	128	262	25.2	37.9	49.8	•	0.020	HS709E.T.P4S	
100000	170000	6	18	36	18	57	119	9.8	15.5	21.1	•	0.020	HC709C.T.P4S	
85000	140000	10	30	59	29	89	179	25.0	37.3	48.5	•	0.020	HC709E.T.P4S	
130000	200000	6	18	36	18	57	119	9.8	15.5	21.1	•	0.020	XC709C.T.P4S	
110000	180000	10	30	59	29	89	179	25.0	37.3	48.5	•	0.020	XC709E.T.P4S	

X-life ultra design
XC708E.T.P4S.UL
XCB708C.T.P4S.UL

See Bearing Code, page 178

SPINDLE BEARINGS

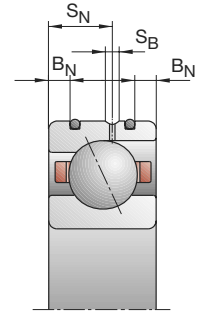
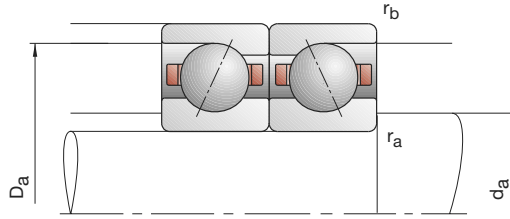
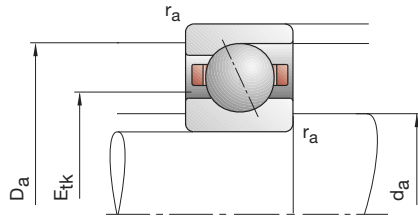

Bearing Code	Dimensions					Abutment Dimensions				DLR Dimensions			Load Ratings		
	d	D	B	r _{smin}	r _{1smin}	d _a h12	D _a H12	r _a max	r _b max	B _N	S _N	S _B	E _{tk}	C _{dyn}	C _{0stat}
FAG	mm													kN	
B71800C.TPA.P4	10	19	5	0.30	0.10	12	17	0.3	0.1				13.3	1.90	0.98
B71800E.TPA.P4	10	19	5	0.30	0.10	12	17	0.3	0.1				13.3	1.80	0.93
HCB71800C.TPA.P4	10	19	5	0.30	0.10	12	17	0.3	0.1				13.3	1.29	0.98
HCB71800E.TPA.P4	10	19	5	0.30	0.10	12	17	0.3	0.1				13.3	1.25	0.65
B71900C.T.P4S	10	22	6	0.30	0.30	13	19.5	0.3	0.3				15.2	3.00	1.53
B71900E.T.P4S	10	22	6	0.30	0.30	13	19.5	0.3	0.3				15.2	2.90	1.46
HCB71900C.T.P4S	10	22	6	0.30	0.30	13	19.5	0.3	0.3				15.2	2.08	1.06
HCB71900E.T.P4S	10	22	6	0.30	0.30	13	19.5	0.3	0.3				15.2	2.00	1.00
XCB71900C.T.P4S	10	22	6	0.30	0.30	13	19.5	0.3	0.3				15.2	4.65	1.06
XCB71900E.T.P4S	10	22	6	0.30	0.30	13	19.5	0.3	0.3				15.2	4.50	1.00
HS71900C.T.P4S	10	22	6	0.30	0.30	13	19.5	0.3	0.3				15.0	1.96	1.10
HS71900E.T.P4S	10	22	6	0.30	0.30	13	19.5	0.3	0.3				15.0	1.86	1.04
HC71900C.T.P4S	10	22	6	0.30	0.30	13	19.5	0.3	0.3				15.0	1.37	0.77
HC71900E.T.P4S	10	22	6	0.30	0.30	13	19.5	0.3	0.3				15.0	1.29	0.72
XC71900C.T.P4S	10	22	6	0.30	0.30	13	19.5	0.3	0.3				15.0	3.05	0.77
XC71900E.T.P4S	10	22	6	0.30	0.30	13	19.5	0.3	0.3				15.0	2.90	0.72
B7000C.T.P4S	10	26	8	0.30	0.30	14	22	0.3	0.1				16.4	4.25	2.08
B7000E.T.P4S	10	26	8	0.30	0.30	14	22	0.3	0.1				16.4	4.05	2.00
HCB7000C.T.P4S	10	26	8	0.30	0.30	14	22	0.3	0.1				16.4	2.90	1.43
HCB7000E.T.P4S	10	26	8	0.30	0.30	14	22	0.3	0.1				16.4	2.80	1.40
XCB7000C.T.P4S	10	26	8	0.30	0.30	14	22	0.3	0.1				16.4	6.40	1.43
XCB7000E.T.P4S	10	26	8	0.30	0.30	14	22	0.3	0.1				16.4	6.30	1.40
HS7000C.T.P4S	10	26	8	0.30	0.30	14	22	0.3	0.1				16.8	2.75	1.60
HS7000E.T.P4S	10	26	8	0.30	0.30	14	22	0.3	0.1				16.8	2.60	1.50
HC7000C.T.P4S	10	26	8	0.30	0.30	14	22	0.3	0.1				16.8	1.90	1.10
HC7000E.T.P4S	10	26	8	0.30	0.30	14	22	0.3	0.1				16.8	1.80	1.06
XC7000C.T.P4S	10	26	8	0.30	0.30	14	22	0.3	0.1				16.8	4.30	1.10
XC7000E.T.P4S	10	26	8	0.30	0.30	14	22	0.3	0.1				16.8	4.00	1.06
B7200C.T.P4S	10	30	9	0.60	0.60	14.5	25.5	0.6	0.6				18.8	5.85	2.90
B7200E.T.P4S	10	30	9	0.60	0.60	14.5	25.5	0.6	0.6				18.8	5.60	2.80
HCB7200C.T.P4S	10	30	9	0.60	0.60	14.5	25.5	0.6	0.6				18.8	4.00	2.04
HCB7200E.T.P4S	10	30	9	0.60	0.60	14.5	25.5	0.6	0.6				18.8	3.90	1.96
Designation examples:															
						Sealed design					Hybrid ceramic design				
						B7000C.2RSD.T.P4S.UL					HCB7000C.T.P4S.UL				
						HSS7000E.T.P4S.UL					HCB71800C.TPA.P4.UL				

SPINDLE BEARINGS

B718..C/E, B719, B70, B72 HS719..C/E, HS70

C: Contact Angle $\alpha = 15^\circ$ / E: Contact Angle $\alpha = 25^\circ$

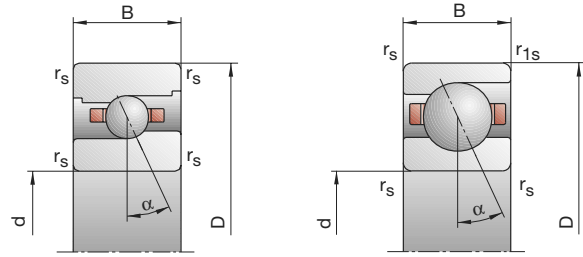

Attainable Speed	Preloading Force			Unloading Force			Axial Rigidity			Sealed Design	Weight	Bearing Code	
	Grease	Oil minimal	F _V	L	M	H	K _{aE}	L	M				H
min ⁻¹		N									N/μm	kg	FAG
75000	120000	7	23	54	21	76	194	9.3	16.2	25.4	–	0.005	B71800C.TPA.P4
70000	110000	8	31	80	23	91	246	20.1	33.1	49.2	–	0.005	B71800E.TPA.P4
95000	160000	4	13	33	12	41	112	8.5	13.8	21.5	–	0.005	HCB71800C.TPA.P4
85000	140000	6	21	48	17	62	145	20.2	32.5	44.6	–	0.005	HCB71800E.TPA.P4
70000	110000	14	51	114	44	179	438	12.6	23.5	36.6	•	0.009	B71900C.T.P4S
63000	95000	17	63	149	50	193	476	27.0	44.8	64.5	•	0.009	B71900E.T.P4S
90000	150000	5	20	49	15	65	171	9.2	16.7	25.5	•	0.008	HCB71900C.T.P4S
75000	120000	9	25	70	27	75	217	24.9	35.4	52.7	•	0.008	HCB71900E.T.P4S
110000	180000	5	20	49	15	65	171	9.2	16.7	25.5	•	0.008	XCB71900C.T.P4S
100000	170000	9	25	70	27	75	217	24.9	35.4	52.7	•	0.008	XCB71900E.T.P4S
90000	150000	7	20	39	21	65	134	8.9	14.3	19.8	•	0.010	HS71900C.T.P4S
75000	120000	11	32	64	32	95	195	22.0	32.6	42.9	•	0.010	HS71900E.T.P4S
100000	170000	5	14	27	15	44	90	8.8	13.5	18.4	•	0.010	HC71900C.T.P4S
85000	140000	7	22	44	20	65	133	20.8	31.9	41.6	•	0.010	HC71900E.T.P4S
130000	200000	5	14	27	15	44	90	8.8	13.5	18.4	•	0.010	XC71900C.T.P4S
110000	180000	7	22	44	20	65	133	20.8	31.9	41.6	•	0.010	XC71900E.T.P4S
60000	90000	17	67	145	53	227	531	12.6	23.3	34.9	•	0.02	B7000C.T.P4S
56000	85000	22	100	224	64	303	706	27.9	49.6	69.4	•	0.02	B7000E.T.P4S
80000	130000	7	32	73	21	103	249	9.9	18.4	27.0	•	0.02	HCB7000C.T.P4S
67000	100000	11	43	110	32	128	337	24.8	40.4	58.1	•	0.02	HCB7000E.T.P4S
100000	170000	7	32	73	21	103	249	9.9	18.4	27.0	•	0.02	XCB7000C.T.P4S
85000	140000	11	43	110	32	128	337	24.8	40.4	58.1	•	0.02	XCB7000E.T.P4S
80000	130000	9	27	55	27	87	187	10.7	17.3	24.2	•	0.02	HS7000C.T.P4S
67000	100000	15	44	89	44	131	271	27.2	40.1	52.9	•	0.02	HS7000E.T.P4S
90000	150000	6	19	38	18	60	125	10.3	16.5	22.5	•	0.02	HC7000C.T.P4S
75000	120000	10	31	62	29	92	188	26.3	39.7	51.7	•	0.02	HC7000E.T.P4S
120000	190000	6	19	38	18	60	125	10.3	16.5	22.5	•	0.02	XC7000C.T.P4S
100000	170000	10	31	62	29	92	188	26.3	39.7	51.7	•	0.02	XC7000E.T.P4S
56000	85000	25	92	198	77	313	730	16.2	29.9	44.9	•	0.03	B7200C.T.P4S
50000	75000	31	139	312	89	419	980	35.0	62.5	88.2	•	0.03	B7200E.T.P4S
70000	110000	13	57	126	39	186	441	13.9	26.2	38.8	•	0.03	HCB7200C.T.P4S
60000	90000	22	81	194	64	241	597	35.4	56.9	80.7	•	0.03	HCB7200E.T.P4S

X-life ultra design
XC7000E.T.P4S.UL
XCB7000C.T.P4S.UL

See Bearing Code, page 178

SPINDLE BEARINGS

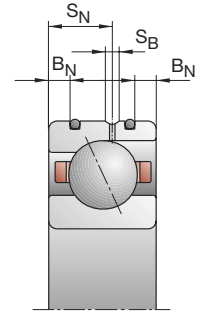
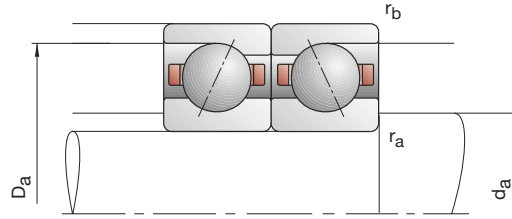
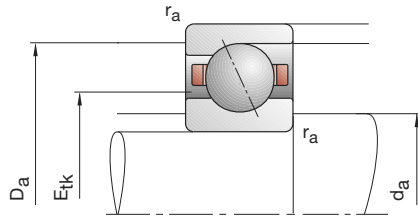

Bearing Code	Dimensions					Abutment Dimensions				DLR Dimensions			Load Ratings		
	d	D	B	r _{smin}	r _{1smin}	d _a h12	D _a H12	r _a max	r _b max	B _N	S _N	S _B	E _{tk}	C _{dyn}	C _{0stat}
FAG	mm													kN	
B71801C.TPA.P4	12	21	5	0.30	0.10	14	19	0.3	0.1				15.3	2.08	1.18
B71801E.TPA.P4	12	21	5	0.30	0.10	14	19	0.3	0.1				15.3	1.96	1.12
HCB71801C.TPA.P4	12	21	5	0.30	0.10	14	19	0.3	0.1				15.3	1.43	0.83
HCB71801E.TPA.P4	12	21	5	0.30	0.10	14	19	0.3	0.1				15.3	1.34	0.78
B71901C.T.P4S	12	24	6	0.30	0.30	15	21.5	0.3	0.3				17.2	3.35	1.86
B71901E.T.P4S	12	24	6	0.30	0.30	15	21.5	0.3	0.3				17.2	3.20	1.76
HCB71901C.T.P4S	12	24	6	0.30	0.30	15	21.5	0.3	0.3				17.2	2.32	1.29
HCB71901E.T.P4S	12	24	6	0.30	0.30	15	21.5	0.3	0.3				17.2	2.20	1.22
XCB71901C.T.P4S	12	24	6	0.30	0.30	15	21.5	0.3	0.3				17.2	5.20	1.29
XCB71901E.T.P4S	12	24	6	0.30	0.30	15	21.5	0.3	0.3				17.2	5.00	1.22
HS71901C.T.P4S	12	24	6	0.30	0.30	15	21.5	0.3	0.3				17.0	2.04	1.20
HS71901E.T.P4S	12	24	6	0.30	0.30	15	21.5	0.3	0.3				17.0	1.93	1.14
HC71901C.T.P4S	12	24	6	0.30	0.30	15	21.5	0.3	0.3				17.0	1.40	0.83
HC71901E.T.P4S	12	24	6	0.30	0.30	15	21.5	0.3	0.3				17.0	1.34	0.80
XC71901C.T.P4S	12	24	6	0.30	0.30	15	21.5	0.3	0.3				17.0	3.15	0.83
XC71901E.T.P4S	12	24	6	0.30	0.30	15	21.5	0.3	0.3				17.0	3.00	0.80
B7001C.T.P4S	12	28	8	0.30	0.30	16.5	24.5	0.3	0.1				18.6	4.75	2.60
B7001E.T.P4S	12	28	8	0.30	0.30	16.5	24.5	0.3	0.1				18.6	4.55	2.50
HCB7001C.T.P4S	12	28	8	0.30	0.30	16.5	24.5	0.3	0.1				18.6	3.25	1.80
HCB7001E.T.P4S	12	28	8	0.30	0.30	16.5	24.5	0.3	0.1				18.6	3.15	1.73
XCB7001C.T.P4S	12	28	8	0.30	0.30	16.5	24.5	0.3	0.1				18.6	7.20	1.73
XCB7001E.T.P4S	12	28	8	0.30	0.30	16.5	24.5	0.3	0.1				18.6	7.10	1.73
HS7001C.T.P4S	12	28	8	0.30	0.30	16.5	24.5	0.3	0.1				18.8	2.70	1.63
HS7001E.T.P4S	12	28	8	0.30	0.30	16.5	24.5	0.3	0.1				18.8	2.55	1.53
HC7001C.T.P4S	12	28	8	0.30	0.30	16.5	24.5	0.3	0.1				18.8	1.86	1.12
HC7001E.T.P4S	12	28	8	0.30	0.30	16.5	24.5	0.3	0.1				18.8	1.76	1.08
XC7001C.T.P4S	12	28	8	0.30	0.30	16.5	24.5	0.3	0.1				18.8	4.15	1.12
XC7001E.T.P4S	12	28	8	0.30	0.30	16.5	24.5	0.3	0.1				18.8	3.90	1.08
B7201C.T.P4S	12	32	10	0.60	0.60	16.5	27.5	0.6	0.6				21.1	7.65	3.90
B7201E.T.P4S	12	32	10	0.60	0.60	16.5	27.5	0.6	0.6				21.1	7.35	3.75
HCB7201C.T.P4S	12	32	10	0.60	0.60	16.5	27.5	0.6	0.6				21.1	5.30	2.70
HCB7201E.T.P4S	12	32	10	0.60	0.60	16.5	27.5	0.6	0.6				21.1	5.10	2.60
Designation examples:															
					Sealed design					Hybrid ceramic design					
					B7001C.2RSD.T.P4S.UL					HCB7001C.T.P4S.UL					
					HSS7001E.T.P4S.UL					HCB71801C.TPA.P4.UL					

SPINDLE BEARINGS

B718..C/E, B719, B70, B72 HS719..C/E, HS70

C: Contact Angle $\alpha = 15^\circ$ / E: Contact Angle $\alpha = 25^\circ$

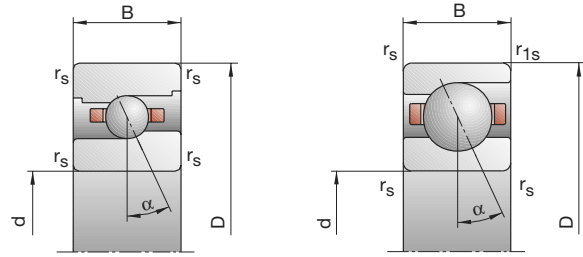

Attainable Speed	Grease	Oil minimal	Preloading Force F_V			Unloading Force K_{aE}			Axial Rigidity S_a			Sealed Design	Weight	Bearing Code
			L	M	H	L	M	H	L	M	H			
min ⁻¹			N			N/μm			kg				FAG	
67000	100000	7	25	58	21	82	207	10.2	18.3	28.3	–	0.01	B71801C.TPA.P4	
60000	90000	8	33	85	23	97	260	22.3	37.4	55.1	–	0.01	B71801E.TPA.P4	
85000	140000	4	13	35	12	41	118	9.4	15.2	23.9	–	0.01	HCB71801C.TPA.P4	
75000	120000	7	22	51	20	64	153	23.7	35.9	50.0	–	0.01	HCB71801E.TPA.P4	
60000	90000	15	56	126	47	195	479	14.3	26.8	41.5	•	0.01	B71901C.T.P4S	
56000	85000	19	67	162	56	204	515	31.4	50.7	73.5	•	0.01	B71901E.T.P4S	
80000	130000	6	22	54	18	71	187	11.0	19.0	29.1	•	0.01	HCB71901C.T.P4S	
67000	100000	10	26	75	29	78	231	27.9	40.0	59.8	•	0.01	HCB71901E.T.P4S	
100000	170000	6	22	54	18	71	187	11.0	19.0	29.1	•	0.01	XCB71901C.T.P4S	
85000	140000	10	26	75	29	78	231	27.9	40.0	59.8	•	0.01	XCB71901E.T.P4S	
80000	130000	7	21	41	21	68	140	9.3	15.2	21.0	•	0.01	HS71901C.T.P4S	
67000	100000	11	33	66	32	98	201	23.1	34.5	45.4	•	0.01	HS71901E.T.P4S	
90000	150000	5	14	28	15	44	93	9.3	14.1	19.4	•	0.01	HC71901C.T.P4S	
80000	130000	8	23	46	23	68	139	23.0	34.0	44.4	•	0.01	HC71901E.T.P4S	
120000	190000	5	14	28	15	44	93	9.3	14.1	19.4	•	0.01	XC71901C.T.P4S	
100000	170000	8	23	46	23	68	139	23.0	34.0	44.4	•	0.01	XC71901E.T.P4S	
56000	85000	19	74	161	58	249	584	14.5	26.9	40.1	•	0.02	B7001C.T.P4S	
50000	75000	23	110	250	67	332	784	32.0	57.4	80.6	•	0.02	B7001E.T.P4S	
70000	110000	9	44	99	27	141	339	13.1	25.2	37.3	•	0.02	HCB7001C.T.P4S	
60000	90000	15	58	147	43	170	445	32.8	53.6	77.2	•	0.02	HCB7001E.T.P4S	
90000	150000	9	44	99	27	141	339	13.1	25.2	37.3	•	0.02	XCB7001C.T.P4S	
75000	120000	15	58	147	43	170	445	32.8	53.6	77.2	•	0.02	XCB7001E.T.P4S	
70000	110000	9	27	54	27	87	184	10.7	17.3	24.1	•	0.02	HS7001C.T.P4S	
60000	90000	15	44	87	44	131	264	27.2	40.2	52.3	•	0.02	HS7001E.T.P4S	
80000	130000	6	19	38	18	60	125	10.3	16.5	22.5	•	0.02	HC7001C.T.P4S	
70000	110000	10	30	61	29	89	184	26.3	39.2	51.2	•	0.02	HC7001E.T.P4S	
100000	170000	6	19	38	18	60	125	10.3	16.5	22.5	•	0.02	XC7001C.T.P4S	
90000	150000	10	30	61	29	89	184	26.3	39.2	51.2	•	0.02	XC7001E.T.P4S	
50000	75000	35	124	264	108	422	971	19.1	34.7	51.8	•	0.04	B7201C.T.P4S	
45000	67000	47	191	420	136	576	1319	42.7	73.3	102.4	•	0.04	B7201E.T.P4S	
63000	95000	19	78	170	57	254	593	16.6	30.6	45.0	•	0.03	HCB7201C.T.P4S	
56000	85000	32	113	263	93	337	809	42.2	67.2	94.0	•	0.03	HCB7201E.T.P4S	

X-life ultra design
XC7001E.T.P4S.UL
XCB7001C.T.P4S.UL

See Bearing Code, page 178

SPINDLE BEARINGS

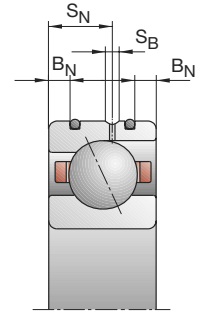
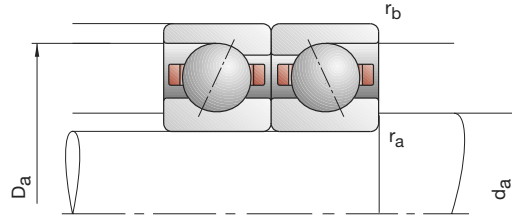
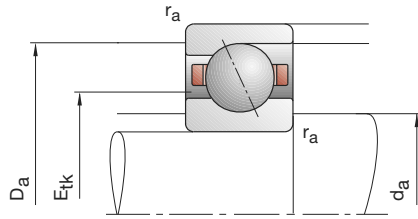

Bearing Code	Dimensions					Abutment Dimensions				DLR Dimensions			Load Ratings		
	d	D	B	r _{smin}	r _{1smin}	d _a h12	D _a H12	r _a max	r _b max	B _N	S _N	S _B	E _{tk}	C _{dyn}	C _{0stat}
FAG	mm													kN	
B71802C.TPA.P4	15	24	5	0.30	0.10	17	22	0.3	0.1				18.3	2.28	1.50
B71802E.TPA.P4	15	24	5	0.30	0.10	17	22	0.3	0.1				18.3	2.16	1.40
HCB71802C.TPA.P4	15	24	5	0.30	0.10	17	22	0.3	0.1				18.3	1.60	1.04
HCB71802E.TPA.P4	15	24	5	0.30	0.10	17	22	0.3	0.1				18.3	1.50	0.98
B71902C.T.P4S	15	28	7	0.30	0.30	18	25.5	0.3	0.3				20.9	5.00	2.90
B71902E.T.P4S	15	28	7	0.30	0.30	18	25.5	0.3	0.3				20.9	4.80	2.75
HCB71902C.T.P4S	15	28	7	0.30	0.30	18	25.5	0.3	0.3				20.9	3.45	2.00
HCB71902E.T.P4S	15	28	7	0.30	0.30	18	25.5	0.3	0.3				20.9	3.35	1.93
XCB71902C.T.P4S	15	28	7	0.30	0.30	18	25.5	0.3	0.3				20.9	7.70	2.00
XCB71902E.T.P4S	15	28	7	0.30	0.30	18	25.5	0.3	0.3				20.9	7.50	1.93
HS71902C.T.P4S	15	28	7	0.30	0.30	18	25.5	0.3	0.3				20.3	2.80	1.76
HS71902E.T.P4S	15	28	7	0.30	0.30	18	25.5	0.3	0.3				20.3	2.65	1.66
HC71902C.T.P4S	15	28	7	0.30	0.30	18	25.5	0.3	0.3				20.3	1.93	1.22
HC71902E.T.P4S	15	28	7	0.30	0.30	18	25.5	0.3	0.3				20.3	1.83	1.16
XC71902C.T.P4S	15	28	7	0.30	0.30	18	25.5	0.3	0.3				20.3	4.30	1.22
XC71902E.T.P4S	15	28	7	0.30	0.30	18	25.5	0.3	0.3				20.3	4.05	1.16
B7002C.T.P4S	15	32	9	0.30	0.30	19	29	0.3	0.1				22.3	6.20	3.40
B7002E.T.P4S	15	32	9	0.30	0.30	19	29	0.3	0.1				22.3	6.00	3.25
HCB7002C.T.P4S	15	32	9	0.30	0.30	19	29	0.3	0.1				22.3	4.30	2.36
HCB7002E.T.P4S	15	32	9	0.30	0.30	19	29	0.3	0.1				22.3	4.15	2.24
XCB7002C.T.P4S	15	32	9	0.30	0.30	19	29	0.3	0.1				22.3	9.65	2.36
XCB7002E.T.P4S	15	32	9	0.30	0.30	19	29	0.3	0.1				22.3	9.30	2.24
HS7002C.T.P4S	15	32	9	0.30	0.30	19	29	0.3	0.1				22.2	3.75	2.45
HS7002E.T.P4S	15	32	9	0.30	0.30	19	29	0.3	0.1				22.2	3.55	2.32
HC7002C.T.P4S	15	32	9	0.30	0.30	19	29	0.3	0.1				22.2	2.60	1.70
HC7002E.T.P4S	15	32	9	0.30	0.30	19	29	0.3	0.1				22.2	2.45	1.60
XC7002C.T.P4S	15	32	9	0.30	0.30	19	29	0.3	0.1				22.2	5.85	1.70
XC7002E.T.P4S	15	32	9	0.30	0.30	19	29	0.3	0.1				22.2	5.50	1.60
B7202C.T.P4S	15	35	11	0.60	0.60	19.5	30.5	0.6	0.6				23.3	9.65	5.00
B7202E.T.P4S	15	35	11	0.60	0.60	19.5	30.5	0.6	0.6				23.3	9.30	4.80
HCB7202C.T.P4S	15	35	11	0.60	0.60	19.5	30.5	0.6	0.6				23.3	6.70	3.45
HCB7202E.T.P4S	15	35	11	0.60	0.60	19.5	30.5	0.6	0.6				23.3	6.40	3.35
Designation examples:															
					Sealed design					Hybrid ceramic design					
					B7002C.2RSD.T.P4S.UL					HCB7002C.T.P4S.UL					
					HSS7002E.T.P4S.UL					HCB71802C.TPA.P4.UL					

SPINDLE BEARINGS

B718..C/E, B719, B70, B72 HS719..C/E, HS70

C: Contact Angle $\alpha = 15^\circ$ / E: Contact Angle $\alpha = 25^\circ$

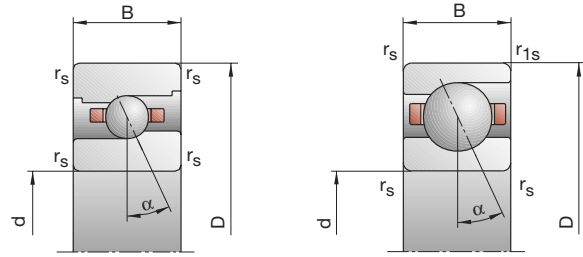

Attainable Speed	Grease	Oil minimal	Preloading Force F_V			Unloading Force K_{aE}			Axial Rigidity S_a			Sealed Design	Weight	Bearing Code
			L	M	H	L	M	H	L	M	H			
min ⁻¹			N			N/μm			N/μm			kg	FAG	
56000	85000		8	27	63	24	88	222	12.2	21.0	32.4	–	0.01	B71802C.TPA.P4
50000	75000		8	34	91	23	99	277	25.3	42.4	63.5	–	0.01	B71802E.TPA.P4
70000	110000		4	14	37	12	44	123	10.6	17.5	27.1	–	0.01	HCB71802C.TPA.P4
63000	95000		7	22	54	20	64	161	27.0	40.8	57.4	–	0.01	HCB71802E.TPA.P4
50000	75000		20	77	167	63	265	624	17.0	31.4	47.4	•	0.02	B71902C.T.P4S
48000	70000		22	112	259	64	342	824	35.0	65.2	92.8	•	0.02	B71902E.T.P4S
67000	100000		11	38	87	34	124	303	15.0	25.0	37.0	•	0.01	HCB71902C.T.P4S
56000	85000		17	48	125	50	144	386	36.3	53.1	76.7	•	0.01	HCB71902E.T.P4S
85000	140000		11	38	87	34	124	303	15.0	25.0	37.0	•	0.01	XCB71902C.T.P4S
70000	110000		17	48	125	50	144	386	36.3	53.1	76.7	•	0.01	XCB71902E.T.P4S
67000	100000		9	28	56	27	90	190	11.2	18.2	25.4	•	0.02	HS71902C.T.P4S
56000	85000		15	46	92	43	136	279	27.8	42.4	55.7	•	0.02	HS71902E.T.P4S
75000	120000		6	19	38	18	60	125	10.8	17.3	23.4	•	0.02	HC71902C.T.P4S
63000	95000		11	32	63	32	95	190	28.5	42.0	54.1	•	0.02	HC71902E.T.P4S
100000	160000		6	19	38	18	60	125	10.8	17.3	23.4	•	0.02	XC71902C.T.P4S
85000	140000		11	32	63	32	95	190	28.5	42.0	54.1	•	0.02	XC71902E.T.P4S
48000	70000		28	102	216	87	345	787	16.9	30.2	44.6	•	0.03	B7002C.T.P4S
43000	63000		36	154	344	105	467	1080	37.4	64.8	90.3	•	0.03	B7002E.T.P4S
60000	90000		11	51	114	33	164	388	13.0	24.4	35.4	•	0.03	HCB7002C.T.P4S
50000	75000		18	68	166	53	203	508	33.4	53.5	75.2	•	0.03	HCB7002E.T.P4S
75000	120000		11	51	114	33	164	388	13.0	24.4	35.4	•	0.03	XCB7002C.T.P4S
67000	100000		18	68	166	53	203	508	33.4	53.5	75.2	•	0.03	XCB7002E.T.P4S
60000	90000		13	38	75	39	122	254	13.8	22.0	30.4	•	0.03	HS7002C.T.P4S
50000	75000		20	61	122	58	181	370	33.7	50.9	66.7	•	0.03	HS7002E.T.P4S
70000	110000		9	26	52	27	82	171	13.5	20.9	28.3	•	0.03	HC7002C.T.P4S
60000	90000		14	42	84	41	125	254	33.9	50.2	65.1	•	0.03	HC7002E.T.P4S
90000	150000		9	26	52	27	82	171	13.5	20.9	28.3	•	0.03	XC7002C.T.P4S
80000	130000		14	42	84	41	125	254	33.9	50.2	65.1	•	0.03	XC7002E.T.P4S
45000	67000		47	165	347	149	575	1309	22.4	40.4	60.2	•	0.04	B7202C.T.P4S
40000	60000		65	256	555	192	789	1779	50.2	85.3	118.6	•	0.04	B7202E.T.P4S
56000	85000		21	86	186	64	283	653	17.9	32.7	47.5	•	0.04	HCB7202C.T.P4S
48000	70000		24	123	286	71	372	892	40.1	72.1	100.5	•	0.04	HCB7202E.T.P4S

X-life ultra design
XC7002E.T.P4S.UL
XCB7002C.T.P4S.UL

See Bearing Code, page 178

SPINDLE BEARINGS

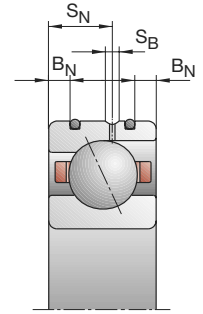
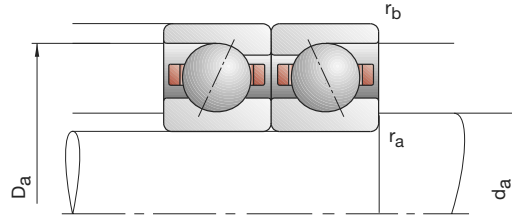
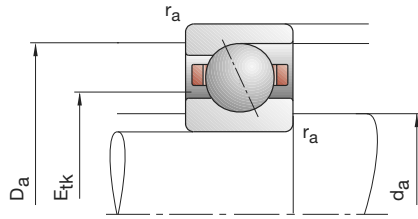

Bearing Code	Dimensions					Abutment Dimensions				DLR Dimensions			Load Ratings			
	d	D	B	r _{smin}	r _{1smin}	d _a h12	D _a H12	r _a max	r _b max	B _N	S _N	S _B	E _{tk}	C _{dyn}	C _{0stat}	
FAG	mm														kN	
B71803C.TPA.P4	17	26	5	0.30	0.10	19	24	0.3	0.1				20.3	2.32	1.60	
B71803E.TPA.P4	17	26	5	0.30	0.10	19	24	0.3	0.1				20.3	2.20	1.53	
HCB71803C.TPA.P4	17	26	5	0.30	0.10	19	24	0.3	0.1				20.3	1.60	1.12	
HCB71803E.TPA.P4	17	26	5	0.30	0.10	19	24	0.3	0.1				20.3	1.53	1.06	
B71903C.T.P4S	17	30	7	0.30	0.30	20	27.5	0.3	0.3				22.2	5.30	3.15	
B71903E.T.P4S	17	30	7	0.30	0.30	20	27.5	0.3	0.3				22.2	5.00	3.00	
HCB71903C.T.P4S	17	30	7	0.30	0.30	20	27.5	0.3	0.3				22.2	3.65	2.20	
HCB71903E.T.P4S	17	30	7	0.30	0.30	20	27.5	0.3	0.3				22.2	3.45	2.08	
XCB71903C.T.P4S	17	30	7	0.30	0.30	20	27.5	0.3	0.3				22.2	8.15	2.20	
XCB71903E.T.P4S	17	30	7	0.30	0.30	20	27.5	0.3	0.3				22.2	7.65	2.08	
HS71903C.T.P4S	17	30	7	0.30	0.30	20	27.5	0.3	0.3				22.3	2.90	1.90	
HS71903E.T.P4S	17	30	7	0.30	0.30	20	27.5	0.3	0.3				22.3	2.70	1.80	
HC71903C.T.P4S	17	30	7	0.30	0.30	20	27.5	0.3	0.3				22.3	2.00	1.34	
HC71903E.T.P4S	17	30	7	0.30	0.30	20	27.5	0.3	0.3				22.3	1.90	1.27	
XC71903C.T.P4S	17	30	7	0.30	0.30	20	27.5	0.3	0.3				22.3	4.50	1.34	
XC71903E.T.P4S	17	30	7	0.30	0.30	20	27.5	0.3	0.3				22.3	4.25	1.27	
B7003C.T.P4S	17	35	10	0.30	0.30	21	32	0.3	0.1				24.1	8.65	4.90	
B7003E.T.P4S	17	35	10	0.30	0.30	21	32	0.3	0.1				24.1	8.30	4.75	
HCB7003C.T.P4S	17	35	10	0.30	0.30	21	32	0.3	0.1				24.1	6.00	3.45	
HCB7003E.T.P4S	17	35	10	0.30	0.30	21	32	0.3	0.1				24.1	5.70	3.25	
XCB7003C.T.P4S	17	35	10	0.30	0.30	21	32	0.3	0.1				24.1	13.40	3.45	
XCB7003E.T.P4S	17	35	10	0.30	0.30	21	32	0.3	0.1				24.1	12.70	3.25	
HS7003C.T.P4S	17	35	10	0.30	0.30	21	32	0.3	0.1				24.7	3.80	2.65	
HS7003E.T.P4S	17	35	10	0.30	0.30	21	32	0.3	0.1				24.7	3.65	2.50	
HC7003C.T.P4S	17	35	10	0.30	0.30	21	32	0.3	0.1				24.7	2.65	1.83	
HC7003E.T.P4S	17	35	10	0.30	0.30	21	32	0.3	0.1				24.7	2.50	1.73	
XC7003C.T.P4S	17	35	10	0.30	0.30	21	32	0.3	0.1				24.7	5.85	1.83	
XC7003E.T.P4S	17	35	10	0.30	0.30	21	32	0.3	0.1				24.7	5.60	1.73	
B7203C.T.P4S	17	40	12	0.60	0.60	22.5	34.5	0.6	0.6				26.7	10.80	5.85	
B7203E.T.P4S	17	40	12	0.60	0.60	22.5	34.5	0.6	0.6				26.7	10.40	5.60	
HCB7203C.T.P4S	17	40	12	0.60	0.60	22.5	34.5	0.6	0.6				26.7	7.50	4.05	
HCB7203E.T.P4S	17	40	12	0.60	0.60	22.5	34.5	0.6	0.6				26.7	7.20	3.90	
Designation examples:																
					Sealed design					Hybrid ceramic design						
					B7003C.2RSD.T.P4S.UL					HCB7003C.T.P4S.UL						
					HSS7003E.T.P4S.UL					HCB71803C.TPA.P4.UL						

SPINDLE BEARINGS

B718..C/E, B719, B70, B72 HS719..C/E, HS70

C: Contact Angle $\alpha = 15^\circ$ / E: Contact Angle $\alpha = 25^\circ$

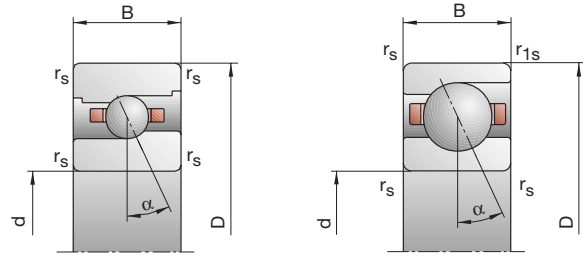

Attainable Speed		Preloading Force			Unloading Force			Axial Rigidity			Sealed Design	Weight	Bearing Code
Grease	Oil minimal	L	M	H	L	M	H	L	M	H			
min ⁻¹		N						N/μm			kg	FAG	
50000	75000	8	26	64	24	84	224	12.6	21.3	33.4	–	0.01	B71803C.TPA.P4
48000	70000	7	33	92	20	96	279	24.9	43.5	65.8	–	0.01	B71803E.TPA.P4
67000	100000	4	13	36	12	40	119	11.0	17.3	27.6	–	0.01	HCB71803C.TPA.P4
56000	85000	7	22	53	20	64	158	28.0	42.3	59.1	–	0.01	HCB71803E.TPA.P4
48000	70000	21	81	176	66	279	656	18.1	33.5	50.4	•	0.02	B71903C.T.P4S
43000	63000	23	116	268	67	354	850	37.4	69.2	98.1	•	0.02	B71903E.T.P4S
60000	90000	11	39	91	34	127	316	15.7	26.4	39.3	•	0.01	HCB71903C.T.P4S
50000	75000	18	50	132	53	150	407	38.9	56.5	81.9	•	0.01	HCB71903E.T.P4S
75000	120000	11	39	91	34	127	316	15.7	26.4	39.3	•	0.01	XCB71903C.T.P4S
67000	100000	18	50	132	53	150	407	38.9	56.5	81.9	•	0.01	XCB71903E.T.P4S
60000	90000	10	29	58	30	93	196	12.1	19.2	26.6	•	0.02	HS71903C.T.P4S
50000	75000	16	47	94	46	139	285	29.7	44.5	58.5	•	0.02	HS71903E.T.P4S
70000	110000	7	20	40	21	63	131	11.9	18.3	24.8	•	0.02	HC71903C.T.P4S
60000	90000	11	32	64	32	95	193	29.7	43.8	56.7	•	0.02	HC71903E.T.P4S
90000	150000	7	20	40	21	63	131	11.9	18.3	24.8	•	0.02	XC71903C.T.P4S
75000	120000	11	32	64	32	95	193	29.7	43.8	56.7	•	0.02	XC71903E.T.P4S
43000	63000	41	146	308	127	492	1115	21.3	37.8	55.4	•	0.04	B7003C.T.P4S
38000	56000	54	221	487	158	668	1527	47.9	81.3	112.6	•	0.04	B7003E.T.P4S
53000	80000	18	73	163	54	234	553	17.2	30.5	44.2	•	0.03	HCB7003C.T.P4S
45000	67000	28	104	249	82	311	762	43.0	68.9	96.1	•	0.03	HCB7003E.T.P4S
70000	110000	18	73	163	54	234	553	17.2	30.5	44.2	•	0.03	XCB7003C.T.P4S
60000	90000	28	104	249	82	311	762	43.0	68.9	96.1	•	0.03	XCB7003E.T.P4S
53000	80000	13	38	76	39	121	256	14.3	22.6	31.5	•	0.04	HS7003C.T.P4S
45000	67000	21	62	124	61	183	375	35.7	53.0	69.5	•	0.04	HS7003E.T.P4S
63000	95000	9	26	53	27	81	173	14.1	21.4	29.4	•	0.04	HC7003C.T.P4S
53000	80000	14	43	86	41	127	259	35.3	52.3	68.0	•	0.04	HC7003E.T.P4S
80000	130000	9	26	53	27	81	173	14.1	21.4	29.4	•	0.04	XC7003C.T.P4S
70000	100000	14	43	86	41	127	259	35.3	52.3	68.0	•	0.04	XC7003E.T.P4S
38000	56000	53	186	391	167	647	1470	23.7	42.9	63.7	•	0.06	B7203C.T.P4S
36000	53000	75	289	626	222	891	2006	53.9	90.7	126.0	•	0.06	B7203E.T.P4S
50000	75000	25	98	212	77	323	744	19.6	34.9	50.6	•	0.06	HCB7203C.T.P4S
43000	63000	28	142	327	82	430	1020	42.7	77.3	107.3	•	0.06	HCB7203E.T.P4S

X-life ultra design
XC7003E.T.P4S.UL
XCB7003C.T.P4S.UL

See Bearing Code, page 178

SPINDLE BEARINGS

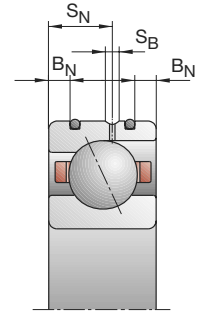
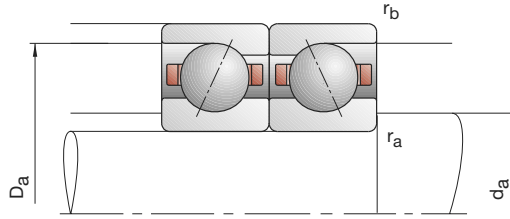
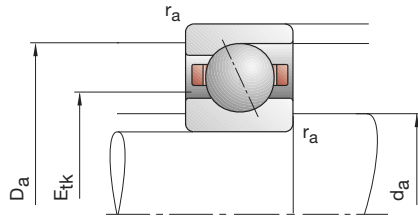

Bearing Code	Dimensions					Abutment Dimensions				DLR Dimensions			Load Ratings		
	d	D	B	r _{smin}	r _{1smin}	d _a h12	D _a H12	r _a max	r _b max	B _N	S _N	S _B	E _{tk}	C _{dyn}	C _{0stat}
FAG	mm													kN	
B71804C.TPA.P4	20	32	7	0.30	0.10	23	29	0.3	0.1				24.5	3.80	2.65
B71804E.TPA.P4	20	32	7	0.30	0.10	23	29	0.3	0.1				24.5	3.65	2.50
HCB71804C.TPA.P4	20	32	7	0.30	0.10	23	29	0.3	0.1				24.5	2.65	1.83
HCB71804E.TPA.P4	20	32	7	0.30	0.10	23	29	0.3	0.1				24.5	2.50	1.73
B71904C.T.P4S	20	37	9	0.30	0.30	24	33.5	0.3	0.3				26.8	7.35	4.55
B71904E.T.P4S	20	37	9	0.30	0.30	24	33.5	0.3	0.3				26.8	6.95	4.40
HCB71904C.T.P4S	20	37	9	0.30	0.30	24	33.5	0.3	0.3				26.8	5.00	3.20
HCB71904E.T.P4S	20	37	9	0.30	0.30	24	33.5	0.3	0.3				26.8	4.80	3.05
XCB71904C.T.P4S	20	37	9	0.30	0.30	24	33.5	0.3	0.3				26.8	11.20	3.20
XCB71904E.T.P4S	20	37	9	0.30	0.30	24	33.5	0.3	0.3				26.8	10.80	3.05
HS71904C.T.P4S	20	37	9	0.30	0.30	24	33.5	0.3	0.3				27.2	3.90	2.85
HS71904E.T.P4S	20	37	9	0.30	0.30	24	33.5	0.3	0.3				27.2	3.75	2.70
HC71904C.T.P4S	20	37	9	0.30	0.30	24	33.5	0.3	0.3				27.2	2.70	1.96
HC71904E.T.P4S	20	37	9	0.30	0.30	24	33.5	0.3	0.3				27.2	2.55	1.86
XC71904C.T.P4S	20	37	9	0.30	0.30	24	33.5	0.3	0.3				27.2	6.00	1.96
XC71904E.T.P4S	20	37	9	0.30	0.30	24	33.5	0.3	0.3				27.2	5.70	1.86
B7004C.T.P4S	20	42	12	0.60	0.60	25	37	0.6	0.3				28.8	10.40	6.00
B7004E.T.P4S	20	42	12	0.60	0.60	25	37	0.6	0.3				28.8	10.00	5.70
HCB7004C.T.P4S	20	42	12	0.60	0.60	25	37	0.6	0.3	2.2	6.6	1.4	28.8	7.20	4.15
HCB7004E.T.P4S	20	42	12	0.60	0.60	25	37	0.6	0.3	2.2	6.6	1.4	28.8	6.95	4.00
XCB7004C.T.P4S	20	42	12	0.60	0.60	25	37	0.6	0.3	2.2	6.6	1.4	28.8	16.00	4.15
XCB7004E.T.P4S	20	42	12	0.60	0.60	25	37	0.6	0.3	2.2	6.6	1.4	28.8	15.60	4.00
HS7004C.T.P4S	20	42	12	0.60	0.60	25	37	0.6	0.3				29.3	6.20	4.55
HS7004E.T.P4S	20	42	12	0.60	0.60	25	37	0.6	0.3				29.3	5.85	4.30
HC7004C.T.P4S	20	42	12	0.60	0.60	25	37	0.6	0.3	2.2	6.6	1.4	29.3	4.30	3.20
HC7004E.T.P4S	20	42	12	0.60	0.60	25	37	0.6	0.3	2.2	6.6	1.4	29.3	4.05	3.00
XC7004C.T.P4S	20	42	12	0.60	0.60	25	37	0.6	0.3	2.2	6.6	1.4	29.3	9.50	3.20
XC7004E.T.P4S	20	42	12	0.60	0.60	25	37	0.6	0.3	2.2	6.6	1.4	29.3	9.00	3.00
B7204C.T.P4S	20	47	14	1.00	1.00	26.5	40.5	1.0	1.0				31.7	14.60	8.15
B7204E.T.P4S	20	47	14	1.00	1.00	26.5	40.5	1.0	1.0				31.7	14.00	7.80
HCB7204C.T.P4S	20	47	14	1.00	1.00	26.5	40.5	1.0	1.0				31.7	10.00	5.60
HCB7204E.T.P4S	20	47	14	1.00	1.00	26.5	40.5	1.0	1.0				31.7	9.65	5.40
Designation examples:															
						Sealed design						Hybrid ceramic design			
						B7004C.2RSD.T.P4S.UL						HCB7004C.T.P4S.UL			
						HSS7004E.T.P4S.UL						HCB71804C.TPA.P4.UL			

SPINDLE BEARINGS

B718..C/E, B719, B70, B72 HS719..C/E, HS70

C: Contact Angle $\alpha = 15^\circ$ / E: Contact Angle $\alpha = 25^\circ$

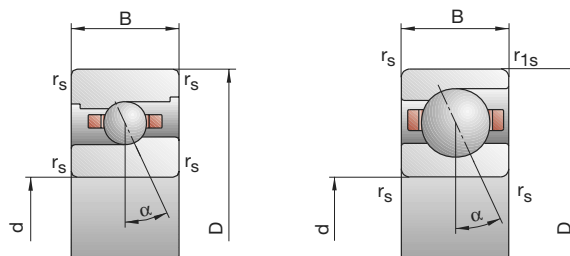

Attainable Speed	Grease	Oil minimal	Preloading Force			Unloading Force			Axial Rigidity			Sealed Design	Weight	Bearing Code
			F _V	L	M	H	K _{aE}	L	M	H	S _a			
min ⁻¹			N						N/μm			kg	FAG	
43000	63000	15	50	114	46	166	411	17.2	29.7	45.6	–	0.02	B71804C.TPA.P4	
38000	56000	18	70	174	52	208	539	37.3	61.8	90.2	–	0.02	B71804E.TPA.P4	
53000	80000	8	29	70	24	92	239	15.0	25.5	38.9	–	0.02	HCB71804C.TPA.P4	
45000	67000	13	48	108	38	142	328	37.9	60.4	82.8	–	0.02	HCB71804E.TPA.P4	
38000	56000	41	137	297	130	478	1127	24.5	43.5	66.1	•	0.03	B71904C.T.P4S	
36000	53000	38	172	390	111	526	1240	47.1	84.0	118.4	•	0.03	B71904E.T.P4S	
50000	75000	13	58	132	39	189	457	17.0	32.1	47.2	•	0.03	HCB71904C.T.P4S	
43000	63000	27	77	193	80	231	595	47.7	69.4	98.9	•	0.03	HCB71904E.T.P4S	
63000	95000	13	58	132	39	189	457	17.0	32.1	47.2	•	0.03	XCB71904C.T.P4S	
56000	85000	27	77	193	80	231	595	47.7	69.4	98.9	•	0.03	XCB71904E.T.P4S	
50000	75000	13	39	78	39	124	262	14.8	23.6	32.8	•	0.04	HS71904C.T.P4S	
43000	63000	21	63	127	61	186	384	37.1	55.3	72.7	•	0.04	HS71904E.T.P4S	
56000	85000	9	27	55	27	84	180	14.6	22.5	31.0	•	0.04	HC71904C.T.P4S	
48000	70000	15	44	89	44	130	268	37.6	54.7	71.4	•	0.04	HC71904E.T.P4S	
75000	120000	9	27	55	27	84	180	14.6	22.5	31.0	•	0.04	XC71904C.T.P4S	
63000	95000	15	44	89	44	130	268	37.6	54.7	71.4	•	0.04	XC71904E.T.P4S	
36000	53000	52	179	377	161	604	1369	22.8	40.0	58.8	•	0.07	B7004C.T.P4S	
32000	48000	71	277	598	207	839	1879	51.7	86.7	119.3	•	0.07	B7004E.T.P4S	
45000	67000	24	94	203	73	303	692	18.9	33.0	47.2	•	0.06	HCB7004C.T.P4S	
38000	56000	26	132	305	76	394	934	41.3	73.6	101.6	•	0.06	HCB7004E.T.P4S	
60000	90000	24	94	203	73	303	692	18.9	33.0	47.2	•	0.06	XCB7004C.T.P4S	
50000	75000	26	132	305	76	394	934	41.3	73.6	101.6	•	0.06	XCB7004E.T.P4S	
45000	67000	21	62	125	63	198	420	19.8	31.5	43.7	•	0.08	HS7004C.T.P4S	
38000	56000	34	101	202	98	299	610	49.1	73.6	96.3	•	0.08	HS7004E.T.P4S	
53000	80000	15	44	87	45	138	284	19.7	30.3	40.9	•	0.08	HC7004C.T.P4S	
45000	67000	23	70	140	67	207	421	48.8	72.6	94.2	•	0.08	HC7004E.T.P4S	
67000	100000	15	44	87	45	138	284	19.7	30.3	40.9	•	0.08	XC7004C.T.P4S	
56000	85000	23	70	140	67	207	421	48.8	72.6	94.2	•	0.08	XC7004E.T.P4S	
32000	48000	74	252	527	229	856	1934	27.8	49.4	73.1	•	0.10	B7204C.T.P4S	
30000	45000	105	393	843	304	1184	2644	63.0	105.0	145.2	•	0.10	B7204E.T.P4S	
43000	63000	45	163	347	137	533	1211	25.4	44.3	64.3	•	0.09	HCB7204C.T.P4S	
36000	53000	56	242	538	162	724	1655	56.9	97.9	134.4	•	0.09	HCB7204E.T.P4S	

Direct-Lube design
HCB7004EDLR.T.P4S.UL
XC7004EDLR.T.P4S.UL

X-life ultra design
XC7004E.T.P4S.UL
XCB7004C.T.P4S.UL

See Bearing Code, page 178

SPINDLE BEARINGS

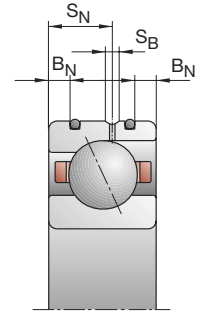
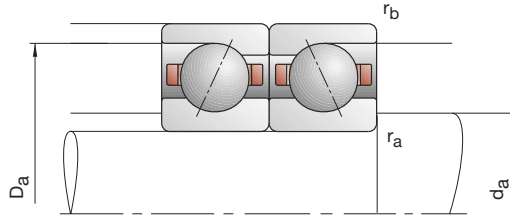
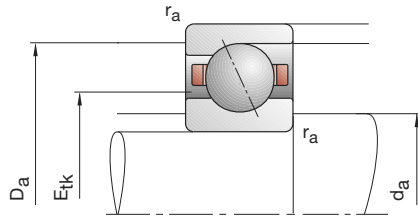

Bearing Code	Dimensions					Abutment Dimensions				DLR Dimensions			Load Ratings		
	d	D	B	r _{smin}	r _{1smin}	d _a h12	D _a H12	r _a max	r _b max	B _N	S _N	S _B	E _{tk}	C _{dyn}	C _{0stat}
FAG	mm													kN	
B71805C.TPA.P4	25	37	7	0.30	0.10	28	34	0.3	0.1				29.5	4.15	3.20
B71805E.TPA.P4	25	37	7	0.30	0.10	28	34	0.3	0.1				29.5	3.90	3.00
HCB71805C.TPA.P4	25	37	7	0.30	0.10	28	34	0.3	0.1				29.5	2.85	2.24
HCB71805E.TPA.P4	25	37	7	0.30	0.10	28	34	0.3	0.1				29.5	2.70	2.12
B71905C.T.P4S	25	42	9	0.30	0.30	29	38.5	0.3	0.3				31.8	8.15	5.70
B71905E.T.P4S	25	42	9	0.30	0.30	29	38.5	0.3	0.3				31.8	7.80	5.50
HCB71905C.T.P4S	25	42	9	0.30	0.30	29	38.5	0.3	0.3				31.8	5.60	4.00
HCB71905E.T.P4S	25	42	9	0.30	0.30	29	38.5	0.3	0.3				31.8	5.30	3.80
XCB71905C.T.P4S	25	42	9	0.30	0.30	29	38.5	0.3	0.3				31.8	12.50	4.00
XCB71905E.T.P4S	25	42	9	0.30	0.30	29	38.5	0.3	0.3				31.8	11.80	3.80
HS71905C.T.P4S	25	42	9	0.30	0.30	29	38.5	0.3	0.3				32.2	4.25	3.35
HS71905E.T.P4S	25	42	9	0.30	0.30	29	38.5	0.3	0.3				32.2	4.00	3.15
HC71905C.T.P4S	25	42	9	0.30	0.30	29	38.5	0.3	0.3				32.2	2.90	2.36
HC71905E.T.P4S	25	42	9	0.30	0.30	29	38.5	0.3	0.3				32.2	2.75	2.20
XC71905C.T.P4S	25	42	9	0.30	0.30	29	38.5	0.3	0.3				32.2	6.40	2.36
XC71905E.T.P4S	25	42	9	0.30	0.30	29	38.5	0.3	0.3				32.2	6.10	2.20
B7005C.T.P4S	25	47	12	0.60	0.60	30	42	0.6	0.3				33.5	14.60	9.15
B7005E.T.P4S	25	47	12	0.60	0.60	30	42	0.6	0.3				33.5	13.70	8.65
HCB7005C.T.P4S	25	47	12	0.60	0.60	30	42	0.6	0.3	2.2	6.6	1.4	33.5	10.00	6.30
HCB7005E.T.P4S	25	47	12	0.60	0.60	30	42	0.6	0.3	2.2	6.6	1.4	33.5	9.50	6.00
XCB7005C.T.P4S	25	47	12	0.60	0.60	30	42	0.6	0.3	2.2	6.6	1.4	33.5	22.40	6.30
XCB7005E.T.P4S	25	47	12	0.60	0.60	30	42	0.6	0.3	2.2	6.6	1.4	33.5	21.20	6.00
HS7005C.T.P4S	25	47	12	0.60	0.60	30	42	0.6	0.3				34.3	6.30	4.90
HS7005E.T.P4S	25	47	12	0.60	0.60	30	42	0.6	0.3				34.3	6.00	4.65
HC7005C.T.P4S	25	47	12	0.60	0.60	30	42	0.6	0.3	2.2	6.6	1.4	34.3	4.30	3.45
HC7005E.T.P4S	25	47	12	0.60	0.60	30	42	0.6	0.3	2.2	6.6	1.4	34.3	4.05	3.25
XC7005C.T.P4S	25	47	12	0.60	0.60	30	42	0.6	0.3	2.2	6.6	1.4	34.3	9.65	3.45
XC7005E.T.P4S	25	47	12	0.60	0.60	30	42	0.6	0.3	2.2	6.6	1.4	34.3	9.00	3.25
B7205C.T.P4S	25	52	15	1.00	1.00	31.5	45.5	1.0	1.0				36.5	15.60	9.30
B7205E.T.P4S	25	52	15	1.00	1.00	31.5	45.5	1.0	1.0				36.5	15.00	9.00
HCB7205C.T.P4S	25	52	15	1.00	1.00	31.5	45.5	1.0	1.0				36.5	10.80	6.55
HCB7205E.T.P4S	25	52	15	1.00	1.00	31.5	45.5	1.0	1.0				36.5	10.40	6.20
Designation examples:															
						Sealed design						Hybrid ceramic design			
						B7005C.2RSD.T.P4S.UL						HCB7005C.T.P4S.UL			
						HSS7005E.T.P4S.UL						HCB71805C.TPA.P4.UL			

SPINDLE BEARINGS

B718..C/E, B719, B70, B72 HS719..C/E, HS70

C: Contact Angle $\alpha = 15^\circ$ / E: Contact Angle $\alpha = 25^\circ$

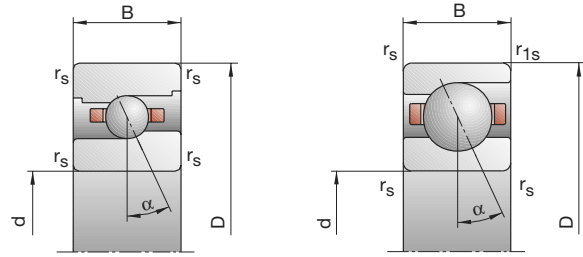

Attainable Speed		Preloading Force F_V			Unloading Force K_{aE}			Axial Rigidity S_a			Sealed Design	Weight	Bearing Code
Grease	Oil minimal	L	M	H	L	M	H	L	M	H		kg	FAG
min ⁻¹		N						N/ μ m					
36000	53000	16	54	123	49	178	439	19.5	33.5	51.2	–	0.02	B71805C.TPA.P4
32000	48000	18	72	181	52	213	557	41.5	69.0	100.6	–	0.02	B71805E.TPA.P4
45000	67000	8	29	73	24	91	247	16.6	27.9	43.2	–	0.02	HCB71805C.TPA.P4
38000	56000	11	49	110	32	144	333	39.7	67.1	92.2	–	0.02	HCB71805E.TPA.P4
32000	48000	40	141	326	125	484	1221	27.0	48.6	75.7	•	0.04	B71905C.T.P4S
30000	45000	40	189	430	117	575	1358	54.5	97.9	137.7	•	0.04	B71905E.T.P4S
43000	63000	13	64	147	39	207	505	19.3	37.3	54.9	•	0.04	HCB71905C.T.P4S
36000	53000	30	84	214	88	251	658	55.7	80.9	116.0	•	0.04	HCB71905E.T.P4S
53000	80000	13	64	147	39	207	505	19.3	37.3	54.9	•	0.04	XCB71905C.T.P4S
48000	70000	30	84	214	88	251	658	55.7	80.9	116.0	•	0.04	XCB71905E.T.P4S
43000	63000	14	42	84	42	133	280	16.8	26.6	36.8	•	0.05	HS71905C.T.P4S
36000	53000	23	69	138	66	203	416	41.9	62.9	82.4	•	0.05	HS71905E.T.P4S
48000	70000	10	29	58	30	90	188	16.7	25.4	34.4	•	0.05	HC71905C.T.P4S
40000	60000	16	47	94	47	139	282	42.6	62.0	80.1	•	0.05	HC71905E.T.P4S
63000	95000	10	29	58	30	90	188	16.7	25.4	34.4	•	0.05	XC71905C.T.P4S
53000	80000	16	47	94	47	139	282	42.6	62.0	80.1	•	0.05	XC71905E.T.P4S
30000	45000	74	254	533	229	852	1921	29.7	51.8	75.7	•	0.08	B7005C.T.P4S
28000	43000	101	384	828	295	1161	2586	67.6	111.9	153.4	•	0.08	B7005E.T.P4S
38000	56000	34	130	281	103	416	950	24.6	42.4	60.4	•	0.06	HCB7005C.T.P4S
34000	50000	39	189	431	114	564	1318	54.9	96.4	132.1	•	0.06	HCB7005E.T.P4S
50000	75000	34	130	281	103	416	950	24.6	42.4	60.4	•	0.06	XCB7005C.T.P4S
43000	63000	39	189	431	114	564	1318	54.9	96.4	132.1	•	0.06	XCB7005E.T.P4S
38000	56000	21	64	127	63	204	426	20.5	32.9	45.3	•	0.09	HS7005C.T.P4S
34000	50000	35	104	207	101	307	624	51.4	76.7	100.3	•	0.09	HS7005E.T.P4S
45000	67000	15	44	87	45	138	283	20.3	31.3	42.1	•	0.09	HC7005C.T.P4S
38000	56000	24	71	143	70	210	430	51.3	75.5	98.1	•	0.09	HC7005E.T.P4S
60000	90000	15	44	87	45	138	283	20.3	31.3	42.1	•	0.09	XC7005C.T.P4S
50000	75000	24	71	143	70	210	430	51.3	75.5	98.1	•	0.09	XC7005E.T.P4S
28000	43000	79	269	562	244	911	2054	30.2	53.5	79.0	•	0.12	B7205C.T.P4S
26000	40000	113	420	901	327	1264	2821	68.8	114.2	157.7	•	0.12	B7205E.T.P4S
36000	53000	47	172	367	142	560	1275	27.3	47.8	69.2	•	0.11	HCB7205C.T.P4S
32000	48000	58	252	563	168	750	1728	61.4	105.2	144.9	•	0.11	HCB7205E.T.P4S

Direct-Lube design
HCB7005EDLR.T.P4S.UL
XC7005EDLR.T.P4S.UL

X-life ultra design
XC7005E.T.P4S.UL
XCB7005C.T.P4S.UL

See Bearing Code, page 178

SPINDLE BEARINGS

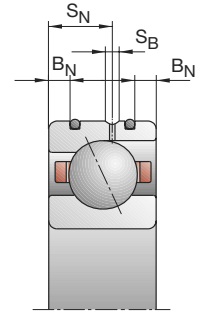
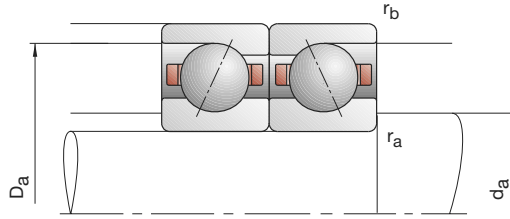
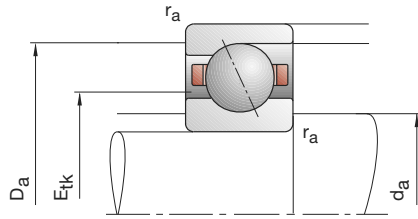

Bearing Code	Dimensions					Abutment Dimensions				DLR Dimensions			Load Ratings			
	d	D	B	r _{smin}	r _{1smin}	d _a h12	D _a H12	r _a max	r _b max	B _N	S _N	S _B	E _{tk}	C _{dyn}	C _{0stat}	
FAG	mm														kN	
B71806C.TPA.P4	30	42	7	0.30	0.10	33	39	0.3	0.1				34.5	4.40	3.65	
B71806E.TPA.P4	30	42	7	0.30	0.10	33	39	0.3	0.1				34.5	4.15	3.40	
HCB71806C.TPA.P4	30	42	7	0.30	0.10	33	39	0.3	0.1				34.5	3.05	2.55	
HCB71806E.TPA.P4	30	42	7	0.30	0.10	33	39	0.3	0.1				34.5	2.85	2.40	
B71906C.T.P4S	30	47	9	0.30	0.30	34	43.5	0.3	0.3				36.8	8.65	6.55	
B71906E.T.P4S	30	47	9	0.30	0.30	34	43.5	0.3	0.3				36.8	8.15	6.30	
HCB71906C.T.P4S	30	47	9	0.30	0.30	34	43.5	0.3	0.3				36.8	6.00	4.65	
HCB71906E.T.P4S	30	47	9	0.30	0.30	34	43.5	0.3	0.3				36.8	5.60	4.40	
XCB71906C.T.P4S	30	47	9	0.30	0.30	34	43.5	0.3	0.3				36.8	13.40	4.65	
XCB71906E.T.P4S	30	47	9	0.30	0.30	34	43.5	0.3	0.3				36.8	12.50	4.40	
HS71906C.T.P4S	30	47	9	0.30	0.30	34	43.5	0.3	0.3				36.8	6.40	5.20	
HS71906E.T.P4S	30	47	9	0.30	0.30	34	43.5	0.3	0.3				36.8	6.00	4.90	
HC71906C.T.P4S	30	47	9	0.30	0.30	34	43.5	0.3	0.3				36.8	4.40	3.65	
HC71906E.T.P4S	30	47	9	0.30	0.30	34	43.5	0.3	0.3				36.8	4.15	3.45	
XC71906C.T.P4S	30	47	9	0.30	0.30	34	43.5	0.3	0.3				36.8	9.80	3.65	
XC71906E.T.P4S	30	47	9	0.30	0.30	34	43.5	0.3	0.3				36.8	9.30	3.45	
B7006C.T.P4S	30	55	13	1.00	1.00	36	49	1.0	0.3				40.4	15.00	10.20	
B7006E.T.P4S	30	55	13	1.00	1.00	36	49	1.0	0.3				40.4	14.30	9.80	
HCB7006C.T.P4S	30	55	13	1.00	1.00	36	49	1.0	0.3	2.8	7.2	1.4	40.4	10.40	7.20	
HCB7006E.T.P4S	30	55	13	1.00	1.00	36	49	1.0	0.3	2.8	7.2	1.4	40.4	10.00	6.80	
XCB7006C.T.P4S	30	55	13	1.00	1.00	36	49	1.0	0.3	2.8	7.2	1.4	40.4	23.20	7.20	
XCB7006E.T.P4S	30	55	13	1.00	1.00	36	49	1.0	0.3	2.8	7.2	1.4	40.4	22.40	6.80	
HS7006C.T.P4S	30	55	13	1.00	1.00	36	49	1.0	0.3				40.5	8.80	7.10	
HS7006E.T.P4S	30	55	13	1.00	1.00	36	49	1.0	0.3				40.5	8.30	6.70	
HC7006C.T.P4S	30	55	13	1.00	1.00	36	49	1.0	0.3	2.8	7.2	1.4	40.5	6.00	4.90	
HC7006E.T.P4S	30	55	13	1.00	1.00	36	49	1.0	0.3	2.8	7.2	1.4	40.5	5.70	4.65	
XC7006C.T.P4S	30	55	13	1.00	1.00	36	49	1.0	0.3	2.8	7.2	1.4	40.5	13.40	4.90	
XC7006E.T.P4S	30	55	13	1.00	1.00	36	49	1.0	0.3	2.8	7.2	1.4	40.5	12.70	4.65	
B7206C.T.P4S	30	62	16	1.00	1.00	37.5	54.5	1.0	1.0				43.7	23.20	14.60	
B7206E.T.P4S	30	62	16	1.00	1.00	37.5	54.5	1.0	1.0				43.7	22.00	14.00	
HCB7206C.T.P4S	30	62	16	1.00	1.00	37.5	54.5	1.0	1.0				43.7	16.00	10.20	
HCB7206E.T.P4S	30	62	16	1.00	1.00	37.5	54.5	1.0	1.0				43.7	15.30	9.80	
Designation examples:																
						Sealed design						Hybrid ceramic design				
						B7006C.2RSD.T.P4S.UL						HCB7006C.T.P4S.UL				
						HSS7006E.T.P4S.UL						HCB71806C.TPA.P4.UL				

SPINDLE BEARINGS

B718..C/E, B719, B70, B72 HS719..C/E, HS70

C: Contact Angle $\alpha = 15^\circ$ / E: Contact Angle $\alpha = 25^\circ$

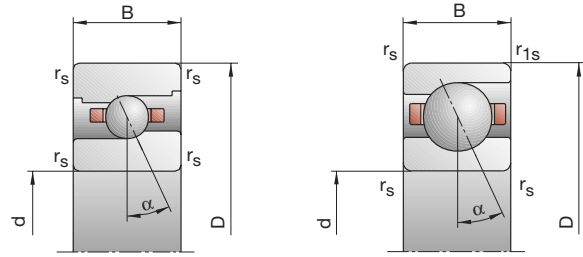

Attainable Speed Grease	Oil minimal	Preloading Force F_V			Unloading Force K_{aE}			Axial Rigidity S_a			Sealed Design	Weight kg	Bearing Code FAG
		L	M	H	L	M	H	L	M	H			
min ⁻¹		N						N/ μ m					
30000	45000	16	56	129	48	183	456	20.9	36.6	56.0	–	0.03	B71806C.TPA.P4
28000	43000	18	73	189	51	215	578	44.6	75.5	110.9	–	0.03	B71806E.TPA.P4
38000	56000	8	30	75	24	94	251	18.2	30.8	46.9	–	0.03	HCB71806C.TPA.P4
34000	50000	13	48	111	37	141	334	45.1	72.9	100.5	–	0.03	HCB71806E.TPA.P4
28000	43000	42	158	345	131	542	1284	29.5	54.3	82.1	•	0.05	B71906C.T.P4S
26000	40000	40	194	445	117	588	1399	58.7	105.7	148.9	•	0.05	B71906E.T.P4S
36000	53000	14	66	153	42	212	522	21.3	40.2	59.2	•	0.04	HCB71906C.T.P4S
32000	48000	30	86	223	88	257	683	59.9	87.7	125.9	•	0.04	HCB71906E.T.P4S
48000	70000	14	66	153	42	212	522	21.3	40.2	59.2	•	0.04	XCB71906C.T.P4S
40000	60000	30	86	223	88	257	683	59.9	87.7	125.9	•	0.04	XCB71906E.T.P4S
36000	53000	21	64	129	63	203	431	21.1	33.7	46.8	•	0.05	HS71906C.T.P4S
32000	48000	35	105	209	101	310	629	53.1	79.4	103.6	•	0.05	HS71906E.T.P4S
43000	63000	15	45	90	45	141	292	21.0	32.6	43.9	•	0.05	HC71906C.T.P4S
36000	53000	24	72	145	70	213	435	53.0	78.3	101.5	•	0.05	HC71906E.T.P4S
53000	80000	15	45	90	45	141	292	21.0	32.6	43.9	•	0.05	XC71906C.T.P4S
48000	70000	24	72	145	70	213	435	53.0	78.3	101.5	•	0.05	XC71906E.T.P4S
26000	40000	75	260	545	234	885	1998	32.7	57.8	85.1	•	0.11	B7006C.T.P4S
24000	38000	102	397	861	300	1211	2721	74.1	124.1	171.3	•	0.11	B7006E.T.P4S
32000	48000	35	137	297	107	445	1022	27.2	47.7	68.5	•	0.10	HCB7006C.T.P4S
28000	43000	38	193	446	111	580	1377	58.9	106.0	146.6	•	0.10	HCB7006E.T.P4S
43000	60000	35	137	297	107	445	1022	27.2	47.7	68.5	•	0.10	XCB7006C.T.P4S
36000	53000	38	193	446	111	580	1377	58.9	106.0	146.6	•	0.10	XCB7006E.T.P4S
32000	48000	29	88	176	87	280	589	24.2	38.7	53.4	•	0.13	HS7006C.T.P4S
28000	43000	48	143	285	139	422	859	60.8	90.6	118.3	•	0.13	HS7006E.T.P4S
38000	56000	20	61	122	60	190	397	23.8	36.9	50.0	•	0.12	HC7006C.T.P4S
32000	48000	33	99	198	96	293	595	60.5	89.6	115.9	•	0.12	HC7006E.T.P4S
50000	75000	20	61	122	60	190	397	23.8	36.9	50.0	•	0.12	XC7006C.T.P4S
40000	60000	33	99	198	96	293	595	60.5	89.6	115.9	•	0.12	XC7006E.T.P4S
24000	38000	122	412	856	388	1445	3250	42.1	75.5	112.3	•	0.19	B7206C.T.P4S
22000	36000	175	637	1357	517	1967	4361	94.8	157.3	217.9	•	0.19	B7206E.T.P4S
30000	45000	75	268	566	233	902	2040	38.4	67.5	98.3	•	0.17	HCB7206C.T.P4S
26000	40000	100	407	895	295	1243	2820	87.5	148.0	203.6	•	0.17	HCB7206E.T.P4S

Direct-Lube design

HCB7006EDLR.T.P4S.UL

XC7006EDLR.T.P4S.UL

X-life ultra design

XC7006E.T.P4S.UL

XCB7006C.T.P4S.UL

See Bearing Code, page 178

SPINDLE BEARINGS

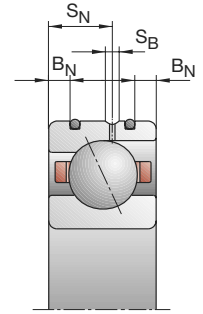
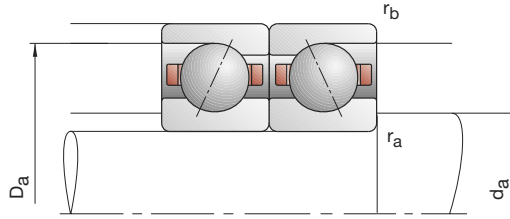
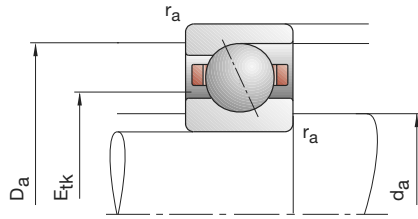

Bearing Code	Dimensions					Abutment Dimensions				DLR Dimensions			Load Ratings		
	d	D	B	r _{smin}	r _{1smin}	d _a h12	D _a H12	r _a max	r _b max	B _N	S _N	S _B	E _{tk}	C _{dyn}	C _{0stat}
FAG	mm													kN	
B71807C.TPA.P4	35	47	7	0.30	0.10	38	44	0.3	0.1				39.5	4.65	4.15
B71807E.TPA.P4	35	47	7	0.30	0.10	38	44	0.3	0.1				39.5	4.40	3.80
HCB71807C.TPA.P4	35	47	7	0.30	0.10	38	44	0.3	0.1				39.5	3.20	2.85
HCB71807E.TPA.P4	35	47	7	0.30	0.10	38	44	0.3	0.1				39.5	3.00	2.65
B71907C.T.P4S	35	55	10	0.60	0.60	40	51.5	0.6	0.6				44.0	11.80	9.50
B71907E.T.P4S	35	55	10	0.60	0.60	40	51.5	0.6	0.6				44.0	11.00	9.00
HCB71907C.T.P4S	35	55	10	0.60	0.60	40	51.5	0.6	0.6				44.0	8.15	6.55
HCB71907E.T.P4S	35	55	10	0.60	0.60	40	51.5	0.6	0.6				44.0	7.65	6.30
XCB71907C.T.P4S	35	55	10	0.60	0.60	40	51.5	0.6	0.6				44.0	18.00	6.55
XCB71907E.T.P4S	35	55	10	0.60	0.60	40	51.5	0.6	0.6				44.0	17.00	6.30
HS71907C.T.P4S	35	55	10	0.60	0.60	40	51.5	0.6	0.6				43.3	6.95	6.20
HS71907E.T.P4S	35	55	10	0.60	0.60	40	51.5	0.6	0.6				43.3	6.55	5.85
HC71907C.T.P4S	35	55	10	0.60	0.60	40	51.5	0.6	0.6				43.3	4.80	4.40
HC71907E.T.P4S	35	55	10	0.60	0.60	40	51.5	0.6	0.6				43.3	4.50	4.05
XC71907C.T.P4S	35	55	10	0.60	0.60	40	51.5	0.6	0.6				43.3	10.80	4.40
XC71907E.T.P4S	35	55	10	0.60	0.60	40	51.5	0.6	0.6				43.3	10.00	4.05
B7007C.T.P4S	35	62	14	1.00	1.00	41	56	1.0	0.3				45.6	19.00	13.70
B7007E.T.P4S	35	62	14	1.00	1.00	41	56	1.0	0.3				45.6	18.30	12.90
HCB7007C.T.P4S	35	62	14	1.00	1.00	41	56	1.0	0.3	2.8	8.0	1.4	45.6	13.20	9.50
HCB7007E.T.P4S	35	62	14	1.00	1.00	41	56	1.0	0.3	2.8	8.0	1.4	45.6	12.50	9.00
XCB7007C.T.P4S	35	62	14	1.00	1.00	41	56	1.0	0.3	2.8	8.0	1.4	45.6	29.00	9.50
XCB7007E.T.P4S	35	62	14	1.00	1.00	41	56	1.0	0.3	2.8	8.0	1.4	45.6	28.00	9.00
HS7007C.T.P4S	35	62	14	1.00	1.00	41	56	1.0	0.3				46.5	9.30	8.30
HS7007E.T.P4S	35	62	14	1.00	1.00	41	56	1.0	0.3				46.5	8.80	7.80
HC7007C.T.P4S	35	62	14	1.00	1.00	41	56	1.0	0.3	2.8	8.0	1.4	46.5	6.40	5.85
HC7007E.T.P4S	35	62	14	1.00	1.00	41	56	1.0	0.3	2.8	8.0	1.4	46.5	6.10	5.40
XC7007C.T.P4S	35	62	14	1.00	1.00	41	56	1.0	0.3	2.8	8.0	1.4	46.5	14.30	5.85
XC7007E.T.P4S	35	62	14	1.00	1.00	41	56	1.0	0.3	2.8	8.0	1.4	46.5	13.70	5.40
B7207C.T.P4S	35	72	17	1.10	1.10	44	63	1.0	1.0				50.7	25.50	18.00
B7207E.T.P4S	35	72	17	1.10	1.10	44	63	1.0	1.0				50.7	24.50	17.00
HCB7207C.T.P4S	35	72	17	1.10	1.10	44	63	1.0	1.0				50.7	17.60	8.80
HCB7207E.T.P4S	35	72	17	1.10	1.10	44	63	1.0	1.0				50.7	16.60	8.50
Designation examples:															
						Sealed design						Hybrid ceramic design			
						B7007C.2RSD.T.P4S.UL						HCB7007C.T.P4S.UL			
						HSS7007E.T.P4S.UL						HCB71807C.TPA.P4.UL			

SPINDLE BEARINGS

B718..C/E, B719, B70, B72 HS719..C/E, HS70

C: Contact Angle $\alpha = 15^\circ$ / E: Contact Angle $\alpha = 25^\circ$

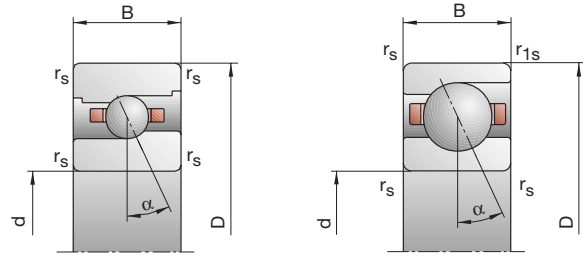

Attainable Speed	Grease	Oil minimal	Preloading Force F_V			Unloading Force K_{aE}			Axial Rigidity S_a			Sealed Design	Weight	Bearing Code
			L	M	H	L	M	H	L	M	H			
min ⁻¹			N			N/μm			N/μm			kg	FAG	
26000	40000		17	58	135	51	189	473	23.1	39.9	60.7	–	0.03	B71807C.TPA.P4
24000	38000		19	76	197	54	223	601	49.4	82.6	121.4	–	0.03	B71807E.TPA.P4
34000	50000		9	30	78	27	93	259	20.6	32.9	50.9	–	0.03	HCB71807C.TPA.P4
30000	45000		13	48	112	37	141	336	48.8	78.9	108.7	–	0.03	HCB71807E.TPA.P4
24000	38000		61	209	481	190	711	1782	36.3	64.1	99.3	•	0.07	B71907C.T.P4S
22000	36000		61	276	619	178	835	1945	73.5	129.4	180.6	•	0.07	B71907E.T.P4S
32000	48000		21	96	217	63	309	741	26.7	49.7	72.4	•	0.06	HCB71907C.T.P4S
26000	40000		44	127	316	129	380	968	74.1	108.9	154.0	•	0.06	HCB71907E.T.P4S
40000	60000		21	96	217	63	309	741	26.7	49.7	72.4	•	0.06	XCB71907C.T.P4S
34000	50000		44	127	316	129	380	968	74.1	108.9	154.0	•	0.06	XCB71907E.T.P4S
32000	48000		24	71	142	72	224	471	24.8	38.9	53.6	•	0.08	HS71907C.T.P4S
26000	40000		38	115	230	110	339	690	61.4	91.7	119.6	•	0.08	HS71907E.T.P4S
36000	53000		16	49	98	48	152	316	24.0	37.1	50.1	•	0.08	HC71907C.T.P4S
30000	45000		26	79	159	75	233	476	60.5	90.4	117.1	•	0.08	HC71907E.T.P4S
48000	70000		16	49	98	48	152	316	24.0	37.1	50.1	•	0.08	XC71907C.T.P4S
40000	60000		26	79	159	75	233	476	60.5	90.4	117.1	•	0.08	XC71907E.T.P4S
22000	36000		97	333	697	303	1132	2548	38.7	67.8	99.5	•	0.15	B7007C.T.P4S
20000	34000		136	518	1116	400	1577	3525	88.4	146.9	202.1	•	0.15	B7007E.T.P4S
28000	43000		46	177	382	140	574	1312	32.2	56.2	80.5	•	0.13	HCB7007C.T.P4S
24000	38000		54	255	581	159	767	1789	72.4	126.2	173.3	•	0.13	HCB7007E.T.P4S
38000	56000		46	177	382	140	574	1312	32.2	56.2	80.5	•	0.13	XCB7007C.T.P4S
32000	48000		54	255	581	159	767	1789	72.4	126.2	173.3	•	0.13	XCB7007E.T.P4S
28000	43000		32	95	190	96	300	632	27.4	43.1	59.5	•	0.17	HS7007C.T.P4S
24000	38000		51	154	308	147	453	926	67.8	101.5	132.7	•	0.17	HS7007E.T.P4S
34000	50000		22	66	131	66	205	424	26.9	41.3	55.7	•	0.17	HC7007C.T.P4S
28000	43000		36	107	214	105	316	642	68.5	100.6	130.2	•	0.17	HC7007E.T.P4S
43000	63000		22	66	131	66	205	424	26.9	41.3	55.7	•	0.17	XC7007C.T.P4S
36000	53000		36	107	214	105	316	642	68.5	100.6	130.2	•	0.17	XC7007E.T.P4S
20000	34000		136	454	942	427	1555	3475	45.3	79.1	116.0	•	0.28	B7207C.T.P4S
19000	32000		197	714	1521	580	2185	4825	103.9	170.4	234.1	•	0.28	B7207E.T.P4S
26000	40000		66	241	514	202	786	1777	37.9	65.1	93.2	•	0.24	HCB7207C.T.P4S
22000	36000		84	362	804	247	1091	2489	86.9	147.5	201.3	•	0.24	HCB7207E.T.P4S

Direct-Lube design
HCB7007EDLR.T.P4S.UL
XC7007EDLR.T.P4S.UL

X-life ultra design
XC7007E.T.P4S.UL
XCB7007C.T.P4S.UL

See Bearing Code, page 178

SPINDLE BEARINGS

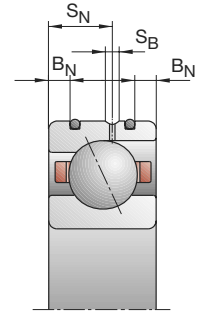
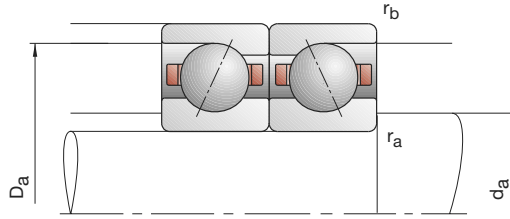
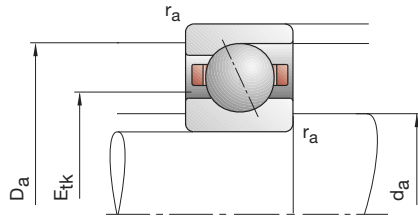

Bearing Code	Dimensions					Abutment Dimensions				DLR Dimensions			Load Ratings		
	d	D	B	r _{smin}	r _{1smin}	d _a h12	D _a H12	r _a max	r _b max	B _N	S _N	S _B	E _{tk}	C _{dyn}	C _{0stat}
FAG	mm													kN	
B71808C.TPA.P4	40	52	7	0.30	0.10	43	49	0.3	0.1				44.5	4.80	4.55
B71808E.TPA.P4	40	52	7	0.30	0.10	43	49	0.3	0.1				44.5	4.55	4.25
HCB71808C.TPA.P4	40	52	7	0.30	0.10	43	49	0.3	0.1				44.5	3.35	3.15
HCB71808E.TPA.P4	40	52	7	0.30	0.10	43	49	0.3	0.1				44.5	3.15	2.90
B71908C.T.P4S	40	62	12	0.60	0.60	45	58.5	0.6	0.6				49.1	17.60	13.70
B71908E.T.P4S	40	62	12	0.60	0.60	45	58.5	0.6	0.6				49.1	16.60	13.20
HCB71908C.T.P4S	40	62	12	0.60	0.60	45	58.5	0.6	0.6	2.2	6.6	1.4	49.1	12.20	9.65
HCB71908E.T.P4S	40	62	12	0.60	0.60	45	58.5	0.6	0.6	2.2	6.6	1.4	49.1	11.40	9.15
XCB71908C.T.P4S	40	62	12	0.60	0.60	45	58.5	0.6	0.6	2.2	6.6	1.4	49.1	27.00	9.65
XCB71908E.T.P4S	40	62	12	0.60	0.60	45	58.5	0.6	0.6	2.2	6.6	1.4	49.1	25.50	9.15
HS71908C.T.P4S	40	62	12	0.60	0.60	45	58.5	0.6	0.6				49.3	7.20	6.95
HS71908E.T.P4S	40	62	12	0.60	0.60	45	58.5	0.6	0.6				49.3	6.80	6.40
HC71908C.T.P4S	40	62	12	0.60	0.60	45	58.5	0.6	0.6	2.2	6.6	1.4	49.3	5.00	4.80
HC71908E.T.P4S	40	62	12	0.60	0.60	45	58.5	0.6	0.6	2.2	6.6	1.4	49.3	4.75	4.50
XC71908C.T.P4S	40	62	12	0.60	0.60	45	58.5	0.6	0.6	2.2	6.6	1.4	49.3	11.20	4.80
XC71908E.T.P4S	40	62	12	0.60	0.60	45	58.5	0.6	0.6	2.2	6.6	1.4	49.3	10.60	4.50
B7008C.T.P4S	40	68	15	1.00	1.00	46	62	1.0	0.3				50.8	20.40	16.00
B7008E.T.P4S	40	68	15	1.00	1.00	46	62	1.0	0.3				50.8	19.60	15.00
HCB7008C.T.P4S	40	68	15	1.00	1.00	46	62	1.0	0.3	2.8	8.5	1.4	50.8	14.30	11.00
HCB7008E.T.P4S	40	68	15	1.00	1.00	46	62	1.0	0.3	2.8	8.5	1.4	50.8	13.40	10.60
XCB7008C.T.P4S	40	68	15	1.00	1.00	46	62	1.0	0.3	2.8	8.5	1.4	50.8	32.00	11.00
XCB7008E.T.P4S	40	68	15	1.00	1.00	46	62	1.0	0.3	2.8	8.5	1.4	50.8	30.00	10.60
HS7008C.T.P4S	40	68	15	1.00	1.00	46	62	1.0	0.3				52.0	10.00	9.30
HS7008E.T.P4S	40	68	15	1.00	1.00	46	62	1.0	0.3				52.0	9.30	8.65
HC7008C.T.P4S	40	68	15	1.00	1.00	46	62	1.0	0.3	2.8	8.5	1.4	52.0	6.80	6.55
HC7008E.T.P4S	40	68	15	1.00	1.00	46	62	1.0	0.3	2.8	8.5	1.4	52.0	6.40	6.10
XC7008C.T.P4S	40	68	15	1.00	1.00	46	62	1.0	0.3	2.8	8.5	1.4	52.0	15.30	6.55
XC7008E.T.P4S	40	68	15	1.00	1.00	46	62	1.0	0.3	2.8	8.5	1.4	52.0	14.30	6.10
B7208C.T.P4S	40	80	18	1.10	1.10	48	72	1.0	1.0				56.7	32.00	22.40
B7208E.T.P4S	40	80	18	1.10	1.10	48	72	1.0	1.0				56.7	30.50	21.60
HCB7208C.T.P4S	40	80	18	1.10	1.10	48	72	1.0	1.0				56.7	22.00	15.60
HCB7208E.T.P4S	40	80	18	1.10	1.10	48	72	1.0	1.0				56.7	21.20	15.00
Designation examples:															
						Sealed design						Hybrid ceramic design			
						B7008C.2RSD.T.P4S.UL						HCB7008C.T.P4S.UL			
						HSS7008E.T.P4S.UL						HCB71808C.TPA.P4.UL			

SPINDLE BEARINGS

B718..C/E, B719, B70, B72 HS719..C/E, HS70

C: Contact Angle $\alpha = 15^\circ$ / E: Contact Angle $\alpha = 25^\circ$

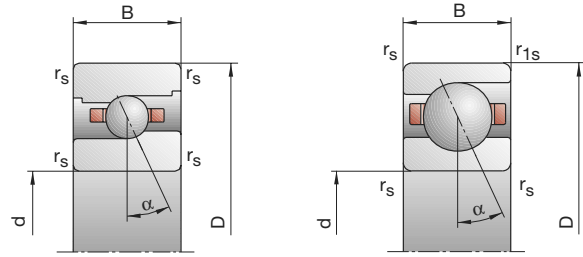

Attainable Speed	Preloading Force			Unloading Force			Axial Rigidity			Sealed Design	Weight	Bearing Code	
	Grease	Oil minimal	F _V	L	M	H	K _{aE}	L	M				H
min ⁻¹			N									kg	FAG
24000	38000	17	59	138	51	190	481	24.7	42.4	64.9	–	0.03	B71808C.TPA.P4
22000	36000	17	75	199	48	220	604	50.8	88.2	129.8	–	0.03	B71808E.TPA.P4
30000	45000	8	29	77	24	90	253	21.2	34.8	53.5	–	0.03	HCB71808C.TPA.P4
26000	40000	16	47	112	46	138	334	56.9	84.0	115.9	–	0.03	HCB71808E.TPA.P4
22000	36000	85	300	633	265	1019	2315	41.1	72.9	107.4	•	0.11	B71908C.T.P4S
20000	34000	112	450	984	328	1366	3101	91.7	155.3	215.0	•	0.11	B71908E.T.P4S
28000	43000	39	156	341	119	505	1170	33.9	59.8	86.1	•	0.09	HCB71908C.T.P4S
24000	38000	76	222	519	224	666	1596	90.7	133.7	185.4	•	0.09	HCB71908E.T.P4S
36000	53000	39	156	341	119	505	1170	33.9	59.8	86.1	•	0.09	XCB71908C.T.P4S
30000	45000	76	222	519	224	666	1596	90.7	133.7	185.4	•	0.09	XCB71908E.T.P4S
28000	43000	25	74	147	75	233	484	27.0	42.3	57.7	•	0.13	HS71908C.T.P4S
24000	38000	40	120	239	115	352	715	66.9	99.9	130.0	•	0.13	HS71908E.T.P4S
32000	48000	17	51	102	51	158	328	26.4	40.5	54.5	•	0.12	HC71908C.T.P4S
28000	43000	28	83	166	81	244	496	67.0	98.7	127.8	•	0.12	HC71908E.T.P4S
40000	60000	17	51	102	51	158	328	26.4	40.5	54.5	•	0.12	XC71908C.T.P4S
36000	53000	28	83	166	81	244	496	67.0	98.7	127.8	•	0.12	XC71908E.T.P4S
20000	34000	102	353	743	318	1201	2722	43.5	76.9	113.2	•	0.19	B7008C.T.P4S
19000	32000	142	547	1180	417	1665	3728	99.2	165.8	228.5	•	0.19	B7008E.T.P4S
26000	40000	48	187	406	146	607	1397	36.2	63.5	91.3	•	0.17	HCB7008C.T.P4S
22000	36000	55	269	617	161	809	1900	80.3	142.5	196.1	•	0.17	HCB7008E.T.P4S
34000	50000	48	187	406	146	607	1397	36.2	63.5	91.3	•	0.17	XCB7008C.T.P4S
28000	43000	55	269	617	161	809	1900	80.3	142.5	196.1	•	0.17	XCB7008E.T.P4S
26000	40000	34	101	201	102	318	665	30.3	47.5	65.2	•	0.22	HS7008C.T.P4S
22000	36000	54	163	327	156	479	981	75.1	112.0	146.4	•	0.22	HS7008E.T.P4S
30000	45000	23	70	139	69	217	448	29.6	45.6	61.2	•	0.20	HC7008C.T.P4S
26000	40000	38	113	225	110	333	673	75.1	110.9	143.1	•	0.20	HC7008E.T.P4S
38000	56000	23	70	139	69	217	448	29.6	45.6	61.2	•	0.20	XC7008C.T.P4S
34000	50000	38	113	225	110	333	673	75.1	110.9	143.1	•	0.20	XC7008E.T.P4S
18000	30000	176	584	1204	554	2007	4451	49.6	86.5	126.5	•	0.37	B7208C.T.P4S
17000	28000	259	912	1925	764	2796	6112	114.2	185.5	253.8	•	0.37	B7208E.T.P4S
24000	38000	89	314	662	273	1027	2296	42.1	71.5	102.0	•	0.33	HCB7208C.T.P4S
20000	34000	118	477	1045	347	1441	3235	97.6	162.5	220.5	•	0.33	HCB7208E.T.P4S

Direct-Lube design
HCB7008EDLR.T.P4S.UL
XC7008EDLR.T.P4S.UL

X-life ultra design
XC7008E.T.P4S.UL
XCB7008C.T.P4S.UL

See Bearing Code, page 178

SPINDLE BEARINGS

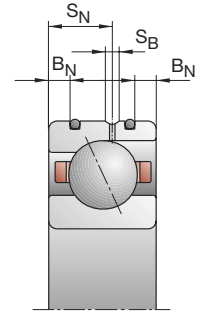
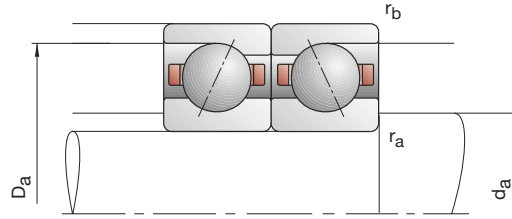
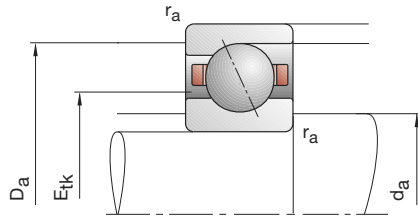

Bearing Code	Dimensions					Abutment Dimensions				DLR Dimensions			Load Ratings		
	d	D	B	r _{smin}	r _{1smin}	d _a h12	D _a H12	r _a max	r _b max	B _N	S _N	S _B	E _{tk}	C _{dyn}	C _{0stat}
FAG	mm													kN	
B71809C.TPA.P4	45	58	7	0.30	0.10	48	55.5	0.3	0.1				49.6	7.20	6.95
B71809E.TPA.P4	45	58	7	0.30	0.10	48	55.5	0.3	0.1				49.6	6.80	6.40
HCB71809C.TPA.P4	45	58	7	0.30	0.10	48	55.5	0.3	0.1				49.6	5.00	4.80
HCB71809E.TPA.P4	45	58	7	0.30	0.10	48	55.5	0.3	0.1				49.6	4.75	4.50
B71909C.T.P4S	45	68	12	0.60	0.60	50	63.5	0.6	0.6				54.4	18.60	15.60
B71909E.T.P4S	45	68	12	0.60	0.60	50	63.5	0.6	0.6				54.4	17.60	15.00
HCB71909C.T.P4S	45	68	12	0.60	0.60	50	63.5	0.6	0.6	2.2	6.6	1.4	54.4	12.90	10.80
HCB71909E.T.P4S	45	68	12	0.60	0.60	50	63.5	0.6	0.6	2.2	6.6	1.4	54.4	12.20	10.40
XCB71909C.T.P4S	45	68	12	0.60	0.60	50	63.5	0.6	0.6	2.2	6.6	1.4	54.4	29.00	10.80
XCB71909E.T.P4S	45	68	12	0.60	0.60	50	63.5	0.6	0.6	2.2	6.6	1.4	54.4	27.00	10.40
HS71909C.T.P4S	45	68	12	0.60	0.60	50	63.5	0.6	0.6				54.5	10.00	9.65
HS71909E.T.P4S	45	68	12	0.60	0.60	50	63.5	0.6	0.6				54.5	9.50	9.00
HC71909C.T.P4S	45	68	12	0.60	0.60	50	63.5	0.6	0.6	2.2	6.6	1.4	54.5	6.95	6.70
HC71909E.T.P4S	45	68	12	0.60	0.60	50	63.5	0.6	0.6	2.2	6.6	1.4	54.5	6.55	6.30
XC71909C.T.P4S	45	68	12	0.60	0.60	50	63.5	0.6	0.6	2.2	6.6	1.4	54.5	15.60	6.70
XC71909E.T.P4S	45	68	12	0.60	0.60	50	63.5	0.6	0.6	2.2	6.6	1.4	54.5	14.60	6.30
B7009C.T.P4S	45	75	16	1.00	1.00	51	69	1.0	0.3				56.2	27.50	21.20
B7009E.T.P4S	45	75	16	1.00	1.00	51	69	1.0	0.3				56.2	26.50	20.00
HCB7009C.T.P4S	45	75	16	1.00	1.00	51	69	1.0	0.3	3.4	9.3	1.4	56.2	19.00	14.60
HCB7009E.T.P4S	45	75	16	1.00	1.00	51	69	1.0	0.3	3.4	9.3	1.4	56.2	18.00	14.00
XCB7009C.T.P4S	45	75	16	1.00	1.00	51	69	1.0	0.3	3.4	9.3	1.4	56.2	42.50	14.60
XCB7009E.T.P4S	45	75	16	1.00	1.00	51	69	1.0	0.3	3.4	9.3	1.4	56.2	40.00	14.00
HS7009C.T.P4S	45	75	16	1.00	1.00	51	69	1.0	0.3				57.7	12.90	12.20
HS7009E.T.P4S	45	75	16	1.00	1.00	51	69	1.0	0.3				57.7	12.20	11.40
HC7009C.T.P4S	45	75	16	1.00	1.00	51	69	1.0	0.3	3.4	9.3	1.4	57.7	8.80	8.50
HC7009E.T.P4S	45	75	16	1.00	1.00	51	69	1.0	0.3	3.4	9.3	1.4	57.7	8.30	8.00
XC7009C.T.P4S	45	75	16	1.00	1.00	51	69	1.0	0.3	3.4	9.3	1.4	57.7	19.60	8.50
XC7009E.T.P4S	45	75	16	1.00	1.00	51	69	1.0	0.3	3.4	9.3	1.4	57.7	18.60	8.00
B7209C.T.P4S	45	85	19	1.10	1.10	52.5	78	1.0	1.0				61.8	33.50	24.50
B7209E.T.P4S	45	85	19	1.10	1.10	52.5	78	1.0	1.0				61.8	32.00	23.60
HCB7209C.T.P4S	45	85	19	1.10	1.10	52.5	78	1.0	1.0				61.8	23.20	12.20
HCB7209E.T.P4S	45	85	19	1.10	1.10	52.5	78	1.0	1.0				61.8	22.00	11.60
Designation examples:															
						Sealed design					Hybrid ceramic design				
						B7009C.2RSD.T.P4S.UL					HCB7009C.T.P4S.UL				
						HSS7009E.T.P4S.UL					HCB71809C.TPA.P4.UL				

SPINDLE BEARINGS

B718..C/E, B719, B70, B72 HS719..C/E, HS70

C: Contact Angle $\alpha = 15^\circ$ / E: Contact Angle $\alpha = 25^\circ$

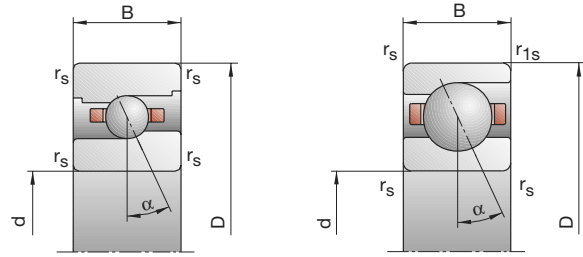

Attainable Speed	Grease	Oil minimal	Preloading Force F_V			Unloading Force K_{aE}			Axial Rigidity S_a			Sealed Design	Weight	Bearing Code
			L	M	H	L	M	H	L	M	H			
min ⁻¹			N			N/μm			kg				FAG	
22000	36000	22	98	221	66	318	774	28.2	53.6	80.7	–	0.04	B71809C.TPA.P4	
19000	32000	35	133	328	100	391	999	69.0	113.1	162.6	–	0.04	B71809E.TPA.P4	
28000	43000	15	53	130	45	165	431	27.5	45.3	68.2	–	0.04	HCB71809C.TPA.P4	
24000	38000	24	85	193	69	249	580	68.6	107.9	147.7	–	0.04	HCB71809E.TPA.P4	
19000	32000	89	315	667	276	1064	2425	44.4	78.7	116.0	•	0.13	B71909C.T.P4S	
18000	30000	116	473	1038	339	1433	3261	99.2	168.8	233.6	•	0.13	B71909E.T.P4S	
24000	38000	41	164	360	124	529	1229	36.6	64.8	93.3	•	0.11	HCB71909C.T.P4S	
22000	36000	79	230	541	232	689	1659	98.2	144.8	200.8	•	0.11	HCB71909E.T.P4S	
32000	48000	41	164	360	124	529	1229	36.6	64.8	93.3	•	0.11	XCB71909C.T.P4S	
28000	43000	79	230	541	232	689	1659	98.2	144.8	200.8	•	0.11	XCB71909E.T.P4S	
24000	38000	34	103	205	102	323	677	31.0	48.8	67.1	•	0.14	HS71909C.T.P4S	
22000	36000	55	166	331	159	487	992	77.5	115.4	150.5	•	0.14	HS71909E.T.P4S	
28000	43000	24	71	142	72	220	457	30.8	46.9	63.1	•	0.13	HC71909C.T.P4S	
24000	38000	38	115	230	110	339	688	77.0	114.4	147.8	•	0.13	HC71909E.T.P4S	
38000	56000	24	71	142	72	220	457	30.8	46.9	63.1	•	0.13	XC71909C.T.P4S	
32000	48000	38	115	230	110	339	688	77.0	114.4	147.8	•	0.13	XC71909E.T.P4S	
18000	30000	145	490	1019	453	1669	3734	50.2	87.8	128.6	•	0.23	B7009C.T.P4S	
17000	28000	209	768	1638	614	2344	5176	115.5	190.0	260.6	•	0.23	B7009E.T.P4S	
24000	38000	72	264	562	220	858	1935	42.5	73.0	104.2	•	0.20	HCB7009C.T.P4S	
20000	34000	90	393	876	264	1182	2706	97.0	165.3	225.7	•	0.20	HCB7009E.T.P4S	
30000	45000	72	264	562	220	858	1935	42.5	73.0	104.2	•	0.20	XCB7009C.T.P4S	
26000	40000	90	393	876	264	1182	2706	97.0	165.3	225.7	•	0.20	XCB7009E.T.P4S	
24000	38000	44	131	263	131	412	870	34.3	54.2	74.9	•	0.27	HS7009C.T.P4S	
20000	34000	71	214	428	204	628	1283	85.7	128.1	167.4	•	0.27	HS7009E.T.P4S	
26000	40000	30	91	182	89	282	586	33.4	52.1	70.2	•	0.26	HC7009C.T.P4S	
24000	38000	49	147	294	142	431	876	85.5	126.1	163.3	•	0.26	HC7009E.T.P4S	
34000	50000	30	91	182	89	282	586	33.4	52.1	70.2	•	0.26	XC7009C.T.P4S	
30000	45000	49	147	294	142	431	876	85.5	126.1	163.3	•	0.26	XC7009E.T.P4S	
17000	28000	184	607	1252	578	2078	4609	52.7	91.5	133.6	•	0.41	B7209C.T.P4S	
15000	24000	270	955	2016	796	2916	6388	121.6	197.3	270.0	•	0.41	B7209E.T.P4S	
22000	36000	93	329	694	285	1074	2400	44.8	76.1	108.3	•	0.34	HCB7209C.T.P4S	
18000	30000	121	493	1083	356	1487	3346	103.4	172.2	233.8	•	0.34	HCB7209E.T.P4S	

Direct-Lube design

HCB7009EDLR.T.P4S.UL

XC7009EDLR.T.P4S.UL

X-life ultra design

XC7009E.T.P4S.UL

XCB7009C.T.P4S.UL

See Bearing Code, page 178

SPINDLE BEARINGS

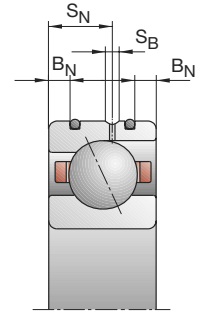
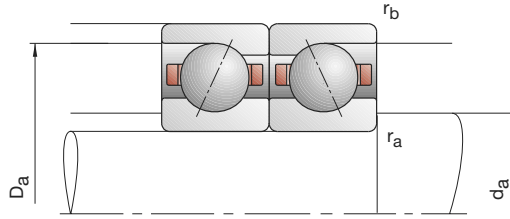
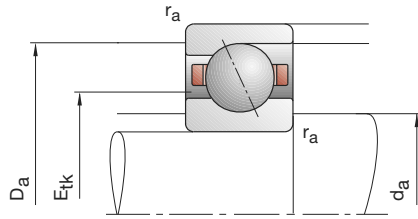

Bearing Code	Dimensions					Abutment Dimensions				DLR Dimensions			Load Ratings			
	d	D	B	r _{smin}	r _{1smin}	d _a h12	D _a H12	r _a max	r _b max	B _N	S _N	S _B	E _{tk}	C _{dyn}	C _{0stat}	
FAG	mm														kN	
B71810C.TPA.P4	50	65	7	0.30	0.10	54	61.5	0.3	0.1				55.6	7.35	7.35	
B71810E.TPA.P4	50	65	7	0.30	0.10	54	61.5	0.3	0.1				55.6	6.95	6.80	
HCB71810C.TPA.P4	50	65	7	0.30	0.10	54	61.5	0.3	0.1				55.6	5.10	5.10	
HCB71810E.TPA.P4	50	65	7	0.30	0.10	54	61.5	0.3	0.1				55.6	4.80	4.75	
B71910C.T.P4S	50	72	12	0.60	0.60	55	67.5	0.6	0.6				58.9	19.00	16.60	
B71910E.T.P4S	50	72	12	0.60	0.60	55	67.5	0.6	0.6				58.9	18.00	15.60	
HCB71910C.T.P4S	50	72	12	0.60	0.60	55	67.5	0.6	0.6	2.2	6.6	1.4	58.9	13.20	11.60	
HCB71910E.T.P4S	50	72	12	0.60	0.60	55	67.5	0.6	0.6	2.2	6.6	1.4	58.9	12.20	11.00	
XCB71910C.T.P4S	50	72	12	0.60	0.60	55	67.5	0.6	0.6	2.2	6.6	1.4	58.9	29.00	11.60	
XCB71910E.T.P4S	50	72	12	0.60	0.60	55	67.5	0.6	0.6	2.2	6.6	1.4	58.9	27.00	11.00	
HS71910C.T.P4S	50	72	12	0.60	0.60	55	67.5	0.6	0.6				59.0	10.40	10.20	
HS71910E.T.P4S	50	72	12	0.60	0.60	55	67.5	0.6	0.6				59.0	9.80	9.65	
HC71910C.T.P4S	50	72	12	0.60	0.60	55	67.5	0.6	0.6	2.2	6.6	1.4	59.0	7.10	7.20	
HC71910E.T.P4S	50	72	12	0.60	0.60	55	67.5	0.6	0.6	2.2	6.6	1.4	59.0	6.70	6.70	
XC71910C.T.P4S	50	72	12	0.60	0.60	55	67.5	0.6	0.6	2.2	6.6	1.4	59.0	16.00	7.20	
XC71910E.T.P4S	50	72	12	0.60	0.60	55	67.5	0.6	0.6	2.2	6.6	1.4	59.0	15.00	6.70	
B7010C.T.P4S	50	80	16	1.00	1.00	56	74	1.0	0.3				61.2	28.50	22.80	
B7010E.T.P4S	50	80	16	1.00	1.00	56	74	1.0	0.3				61.2	27.00	21.60	
HCB7010C.T.P4S	50	80	16	1.00	1.00	56	74	1.0	0.3	3.4	9.3	1.4	61.2	19.60	16.00	
HCB7010E.T.P4S	50	80	16	1.00	1.00	56	74	1.0	0.3	3.4	9.3	1.4	61.2	18.60	15.30	
XCB7010C.T.P4S	50	80	16	1.00	1.00	56	74	1.0	0.3	3.4	9.3	1.4	61.2	44.00	16.00	
XCB7010E.T.P4S	50	80	16	1.00	1.00	56	74	1.0	0.3	3.4	9.3	1.4	61.2	41.50	15.30	
HS7010C.T.P4S	50	80	16	1.00	1.00	56	74	1.0	0.3				62.7	13.40	13.20	
HS7010E.T.P4S	50	80	16	1.00	1.00	56	74	1.0	0.3				62.7	12.50	12.20	
HC7010C.T.P4S	50	80	16	1.00	1.00	56	74	1.0	0.3	3.4	9.3	1.4	62.7	9.15	9.15	
HC7010E.T.P4S	50	80	16	1.00	1.00	56	74	1.0	0.3	3.4	9.3	1.4	62.7	8.65	8.50	
XC7010C.T.P4S	50	80	16	1.00	1.00	56	74	1.0	0.3	3.4	9.3	1.4	62.7	20.40	9.15	
XC7010E.T.P4S	50	80	16	1.00	1.00	56	74	1.0	0.3	3.4	9.3	1.4	62.7	19.30	8.50	
B7210C.T.P4S	50	90	20	1.10	1.10	57	83	1.0	1.0				66.2	43.00	31.50	
B7210E.T.P4S	50	90	20	1.10	1.10	57	83	1.0	1.0				66.2	40.50	30.50	
HCB7210C.T.P4S	50	90	20	1.10	1.10	57	83	1.0	1.0				66.2	30.00	22.00	
HCB7210E.T.P4S	50	90	20	1.10	1.10	57	83	1.0	1.0				66.2	28.00	21.20	
Designation examples:																
						Sealed design						Hybrid ceramic design				
						B7010C.2RSD.T.P4S.UL						HCB7010C.T.P4S.UL				
						HSS7010E.T.P4S.UL						HCB71810C.TPA.P4.UL				

SPINDLE BEARINGS

B718..C/E, B719, B70, B72 HS719..C/E, HS70

C: Contact Angle $\alpha = 15^\circ$ / E: Contact Angle $\alpha = 25^\circ$

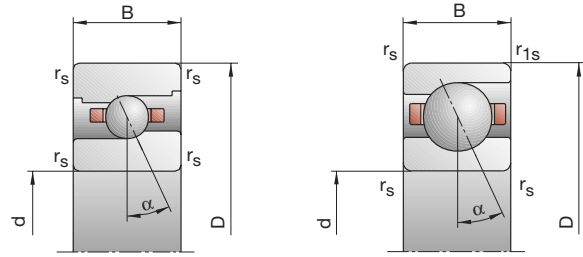

Attainable Speed	Grease	Oil minimal	Preloading Force F_V			Unloading Force K_{aE}			Axial Rigidity S_a			Sealed Design	Weight	Bearing Code
			L	M	H	L	M	H	L	M	H			
min ⁻¹			N						N/ μ m				kg	FAG
19000	32000		21	99	224	62	320	780	28.5	55.9	84.0	–	0.05	B71810C.TPA.P4
17000	28000		34	133	332	97	390	1011	71.4	117.9	170.2	–	0.05	B71810E.TPA.P4
24000	38000		14	52	129	41	162	425	27.5	46.9	70.4	–	0.05	HCB71810C.TPA.P4
20000	34000		25	86	195	72	252	585	72.9	113.3	154.7	–	0.05	HCB71810E.TPA.P4
18000	30000		90	321	679	279	1081	2459	46.0	81.4	119.7	•	0.13	B71910C.T.P4S
16000	26000		118	482	1059	345	1458	3322	103.1	175.1	242.3	•	0.13	B71910E.T.P4S
22000	36000		41	166	366	124	534	1246	37.8	66.9	96.4	•	0.11	HCB71910C.T.P4S
20000	34000		79	232	549	232	694	1681	101.4	149.7	208.0	•	0.11	HCB71910E.T.P4S
30000	43000		41	166	366	124	534	1246	37.8	66.9	96.4	•	0.11	XCB71910C.T.P4S
26000	40000		79	232	549	232	694	1681	101.4	149.7	208.0	•	0.11	XCB71910E.T.P4S
22000	36000		35	105	209	105	329	687	32.8	51.4	70.2	•	0.15	HS71910C.T.P4S
20000	34000		58	173	345	167	507	1033	82.4	122.5	159.7	•	0.15	HS71910E.T.P4S
26000	40000		24	72	145	71	222	465	31.8	49.1	66.2	•	0.14	HC71910C.T.P4S
22000	36000		39	117	235	113	344	702	81.5	120.3	155.8	•	0.14	HC71910E.T.P4S
34000	50000		24	72	145	71	222	465	31.8	49.1	66.2	•	0.14	XC71910C.T.P4S
30000	45000		39	117	235	113	344	702	81.5	120.3	155.8	•	0.14	XC71910E.T.P4S
17000	28000		150	507	1054	468	1722	3850	52.7	92.0	134.7	•	0.25	B7010C.T.P4S
15000	24000		211	779	1663	619	2372	5240	120.4	198.1	271.5	•	0.25	B7010E.T.P4S
22000	36000		74	275	586	226	892	2014	44.6	76.9	109.7	•	0.21	HCB7010C.T.P4S
18000	30000		89	397	889	261	1192	2741	100.5	172.3	235.5	•	0.21	HCB7010E.T.P4S
28000	43000		74	275	586	226	892	2014	44.6	76.9	109.7	•	0.21	XCB7010C.T.P4S
24000	38000		89	397	889	261	1192	2741	100.5	172.3	235.5	•	0.21	XCB7010E.T.P4S
22000	36000		46	137	273	137	430	900	36.7	57.7	79.4	•	0.29	HS7010C.T.P4S
18000	30000		74	222	444	212	650	1329	91.2	136.2	178.0	•	0.29	HS7010E.T.P4S
24000	38000		32	95	190	95	294	610	36.0	55.4	74.7	•	0.27	HC7010C.T.P4S
22000	36000		51	154	308	148	451	917	91.3	134.6	174.3	•	0.27	HC7010E.T.P4S
32000	48000		32	95	190	95	294	610	36.0	55.4	74.7	•	0.27	XC7010C.T.P4S
28000	43000		51	154	308	148	451	917	91.3	134.6	174.3	•	0.27	XC7010E.T.P4S
16000	26000		242	792	1631	761	2708	6004	60.4	104.4	152.5	•	0.46	B7210C.T.P4S
14000	22000		355	1230	2583	1045	3757	8185	139.2	224.3	306.1	•	0.46	B7210E.T.P4S
20000	34000		123	425	893	377	1384	3080	51.4	86.5	122.8	•	0.39	HCB7210C.T.P4S
17000	28000		169	657	1425	498	1985	4409	121.0	198.4	268.1	•	0.39	HCB7210E.T.P4S

Direct-Lube design

HCB7010EDLR.T.P4S.UL

XC7010EDLR.T.P4S.UL

X-life ultra design

XC7010E.T.P4S.UL

XCB7010C.T.P4S.UL

See Bearing Code, page 178

SPINDLE BEARINGS

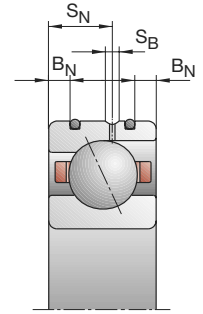
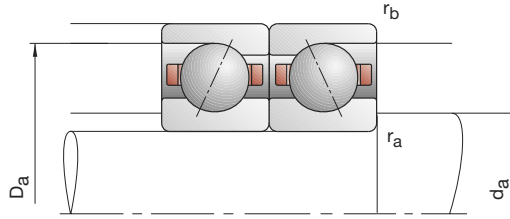
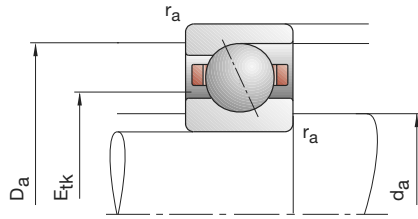

Bearing Code	Dimensions					Abutment Dimensions				DLR Dimensions			Load Ratings		
	d	D	B	r _{smin}	r _{1smin}	d _a h12	D _a H12	r _a max	r _b max	B _N	S _N	S _B	E _{tk}	C _{dyn}	C _{0stat}
FAG	mm													kN	
B71811C.TPA.P4	55	72	9	0.30	0.10	59	68.5	0.3	0.1				61.2	10.20	10.20
B71811E.TPA.P4	55	72	9	0.30	0.10	59	68.5	0.3	0.1				61.2	9.65	9.50
HCB71811C.TPA.P4	55	72	9	0.30	0.10	59	68.5	0.3	0.1				61.2	7.10	7.20
HCB71811E.TPA.P4	55	72	9	0.30	0.10	59	68.5	0.3	0.1				61.2	6.70	6.70
B71911C.T.P4S	55	80	13	1.00	1.00	60	75.5	0.6	0.6				65.1	22.80	20.40
B71911E.T.P4S	55	80	13	1.00	1.00	60	75.5	0.6	0.6				65.1	21.60	19.30
HCB71911C.T.P4S	55	80	13	1.00	1.00	60	75.5	0.6	0.6	2.8	7.2	1.4	65.1	16.00	14.30
HCB71911E.T.P4S	55	80	13	1.00	1.00	60	75.5	0.6	0.6	2.8	7.2	1.4	65.1	15.00	13.40
XCB71911C.T.P4S	55	80	13	1.00	1.00	60	75.5	0.6	0.6	2.8	7.2	1.4	65.1	35.50	14.30
XCB71911E.T.P4S	55	80	13	1.00	1.00	60	75.5	0.6	0.6	2.8	7.2	1.4	65.1	33.50	13.40
HS71911C.T.P4S	55	80	13	1.00	1.00	60	75.5	0.6	0.6				65.2	13.40	13.70
HS71911E.T.P4S	55	80	13	1.00	1.00	60	75.5	0.6	0.6				65.2	12.70	12.70
HC71911C.T.P4S	55	80	13	1.00	1.00	60	75.5	0.6	0.6	2.8	7.2	1.4	65.2	9.30	9.50
HC71911E.T.P4S	55	80	13	1.00	1.00	60	75.5	0.6	0.6	2.8	7.2	1.4	65.2	8.80	8.80
XC71911C.T.P4S	55	80	13	1.00	1.00	60	75.5	0.6	0.6	2.8	7.2	1.4	65.2	20.80	9.50
XC71911E.T.P4S	55	80	13	1.00	1.00	60	75.5	0.6	0.6	2.8	7.2	1.4	65.2	19.60	8.80
B7011C.T.P4S	55	90	18	1.10	1.10	62	83	1.0	0.6				68.1	38.00	31.00
B7011E.T.P4S	55	90	18	1.10	1.10	62	83	1.0	0.6				68.1	36.00	29.00
HCB7011C.T.P4S	55	90	18	1.10	1.10	62	83	1.0	0.6	4.3	9.7	1.4	68.1	26.00	21.60
HCB7011E.T.P4S	55	90	18	1.10	1.10	62	83	1.0	0.6	4.3	9.7	1.4	68.1	25.00	20.40
XCB7011C.T.P4S	55	90	18	1.10	1.10	62	83	1.0	0.6	4.3	9.7	1.4	68.1	58.50	21.60
XCB7011E.T.P4S	55	90	18	1.10	1.10	62	83	1.0	0.6	4.3	9.7	1.4	68.1	56.00	20.40
HS7011C.T.P4S	55	90	18	1.10	1.10	62	83	1.0	0.6				69.7	18.60	19.00
HS7011E.T.P4S	55	90	18	1.10	1.10	62	83	1.0	0.6				69.7	17.60	17.60
HC7011C.T.P4S	55	90	18	1.10	1.10	62	83	1.0	0.6	4.3	9.7	1.4	69.7	12.90	13.20
HC7011E.T.P4S	55	90	18	1.10	1.10	62	83	1.0	0.6	4.3	9.7	1.4	69.7	12.20	12.20
XC7011C.T.P4S	55	90	18	1.10	1.10	62	83	1.0	0.6	4.3	9.7	1.4	69.7	29.00	13.20
XC7011E.T.P4S	55	90	18	1.10	1.10	62	83	1.0	0.6	4.3	9.7	1.4	69.7	27.00	12.20
B7211C.T.P4S	55	100	21	1.50	1.50	63	92	1.5	1.5				73.7	46.50	37.50
B7211E.T.P4S	55	100	21	1.50	1.50	63	92	1.5	1.5				73.7	44.00	35.50
HCB7211C.T.P4S	55	100	21	1.50	1.50	63	92	1.5	1.5				73.7	32.00	18.30
HCB7211E.T.P4S	55	100	21	1.50	1.50	63	92	1.5	1.5				73.7	30.50	17.60
Designation examples:															
					Sealed design					Hybrid ceramic design					
					B7011C.2RSD.T.P4S.UL					HCB7011C.T.P4S.UL					
					HSS7011E.T.P4S.UL					HCB71811C.TPA.P4.UL					

SPINDLE BEARINGS

B718..C/E, B719, B70, B72 HS719..C/E, HS70

C: Contact Angle $\alpha = 15^\circ$ / E: Contact Angle $\alpha = 25^\circ$

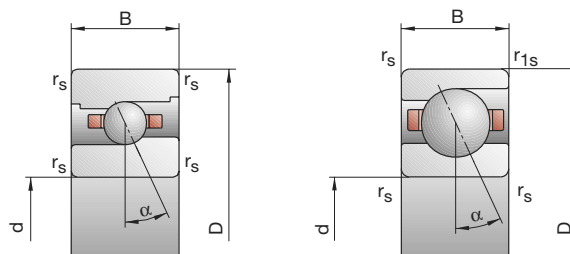

Attainable Speed	Grease	Oil minimal	Preloading Force F_V			Unloading Force K_{aE}			Axial Rigidity S_a			Sealed Design	Weight	Bearing Code
			L	M	H	L	M	H	L	M	H			
min ⁻¹			N			N/μm			kg				FAG	
17000	28000	35	147	326	105	477	1139	35.9	66.8	99.7	–	0.08	B71811C.TPA.P4	
16000	26000	57	206	491	163	607	1497	88.4	142.6	202.4	–	0.08	B71811E.TPA.P4	
22000	36000	17	82	194	50	257	645	30.5	57.4	84.9	–	0.08	HCB71811C.TPA.P4	
19000	32000	30	98	269	86	286	805	80.0	122.1	178.6	–	0.08	HCB71811E.TPA.P4	
16000	26000	112	391	825	347	1317	2985	51.2	90.0	131.9	•	0.18	B71911C.T.P4S	
15000	24000	149	592	1287	436	1791	4036	115.5	194.2	267.4	•	0.18	B71911E.T.P4S	
20000	34000	51	204	444	154	656	1510	42.1	74.2	106.2	•	0.15	HCB71911C.T.P4S	
18000	30000	58	298	693	170	893	2125	94.2	168.8	233.2	•	0.15	HCB71911E.T.P4S	
26000	40000	51	204	444	154	656	1510	42.1	74.2	106.2	•	0.15	XCB71911C.T.P4S	
24000	38000	58	298	693	170	893	2125	94.2	168.8	233.2	•	0.15	XCB71911E.T.P4S	
20000	34000	46	139	279	137	436	919	37.5	59.4	81.8	•	0.20	HS71911C.T.P4S	
18000	30000	75	225	451	215	659	1349	93.9	140.1	183.1	•	0.20	HS71911E.T.P4S	
24000	38000	32	96	193	95	296	619	36.8	56.8	76.7	•	0.19	HC71911C.T.P4S	
20000	34000	52	156	313	150	457	931	93.6	138.5	179.3	•	0.19	HC71911E.T.P4S	
32000	48000	32	96	193	95	296	619	36.8	56.8	76.7	•	0.19	XC71911C.T.P4S	
26000	40000	52	156	313	150	457	931	93.6	138.5	179.3	•	0.19	XC71911E.T.P4S	
15000	24000	207	687	1424	647	2336	5203	61.9	107.2	156.5	•	0.37	B7011C.T.P4S	
14000	22000	298	1066	2257	876	3243	7117	142.4	231.6	316.4	•	0.37	B7011E.T.P4S	
19000	32000	104	373	789	317	1212	2713	52.6	89.6	127.3	•	0.32	HCB7011C.T.P4S	
17000	28000	134	553	1219	394	1664	3754	121.6	202.9	275.4	•	0.32	HCB7011E.T.P4S	
26000	40000	104	373	789	317	1212	2713	52.6	89.6	127.3	•	0.32	XCB7011C.T.P4S	
22000	36000	134	553	1219	394	1664	3754	121.6	202.9	275.4	•	0.32	XCB7011E.T.P4S	
19000	32000	64	192	383	191	603	1264	42.6	67.2	92.4	•	0.43	HS7011C.T.P4S	
17000	28000	105	315	630	301	922	1883	106.6	159.2	207.9	•	0.43	HS7011E.T.P4S	
22000	36000	45	134	268	134	415	861	42.1	64.7	87.1	•	0.40	HC7011C.T.P4S	
19000	32000	73	219	437	211	643	1303	106.7	157.8	203.9	•	0.40	HC7011E.T.P4S	
28000	43000	45	134	268	134	415	861	42.1	64.7	87.1	•	0.40	XC7011C.T.P4S	
24000	38000	73	219	437	211	643	1303	106.7	157.8	203.9	•	0.40	XC7011E.T.P4S	
14000	22000	261	849	1750	816	2885	6395	67.3	115.6	168.4	•	0.61	B7211C.T.P4S	
13000	20000	381	1331	2797	1120	4055	8833	155.5	250.7	341.7	•	0.61	B7211E.T.P4S	
18000	30000	134	466	979	410	1513	3363	57.7	97.0	137.5	•	0.51	HCB7211C.T.P4S	
15000	24000	178	702	1527	524	2111	4710	134.4	220.8	298.5	•	0.51	HCB7211E.T.P4S	

Direct-Lube design

HCB7011EDLR.T.P4S.UL
XC7011EDLR.T.P4S.UL

X-life ultra design

XC7011E.T.P4S.UL
XCB7011C.T.P4S.UL

See Bearing Code, page 178

SPINDLE BEARINGS

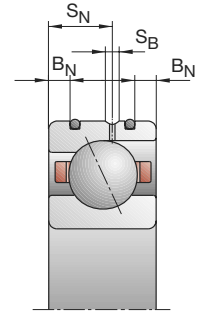
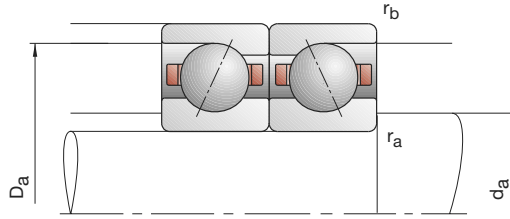
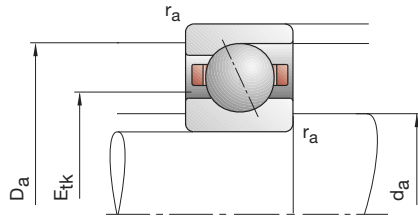

Bearing Code	Dimensions					Abutment Dimensions				DLR Dimensions			Load Ratings		
	d	D	B	r _{smin}	r _{1smin}	d _a h12	D _a H12	r _a max	r _b max	B _N	S _N	S _B	E _{tk}	C _{dyn}	C _{0stat}
FAG	mm													kN	
B71812C.TPA.P4	60	78	10	0.30	0.10	63	74.5	0.3	0.1				66.3	13.20	13.20
B71812E.TPA.P4	60	78	10	0.30	0.10	63	74.5	0.3	0.1				66.3	12.20	12.20
HCB71812C.TPA.P4	60	78	10	0.30	0.10	63	74.5	0.3	0.1				66.3	9.00	9.15
HCB71812E.TPA.P4	60	78	10	0.30	0.10	63	74.5	0.3	0.1				66.3	8.50	8.50
B71912C.T.P4S	60	85	13	1.00	1.00	65	80.5	0.6	0.6				70.1	24.00	22.80
B71912E.T.P4S	60	85	13	1.00	1.00	65	80.5	0.6	0.6				70.1	22.80	21.60
HCB71912C.T.P4S	60	85	13	1.00	1.00	65	80.5	0.6	0.6	2.8	7.2	1.4	70.1	16.60	16.00
HCB71912E.T.P4S	60	85	13	1.00	1.00	65	80.5	0.6	0.6	2.8	7.2	1.4	70.1	15.60	15.00
XCB71912C.T.P4S	60	85	13	1.00	1.00	65	80.5	0.6	0.6	2.8	7.2	1.4	70.1	37.50	16.00
XCB71912E.T.P4S	60	85	13	1.00	1.00	65	80.5	0.6	0.6	2.8	7.2	1.4	70.1	34.50	15.00
HS71912C.T.P4S	60	85	13	1.00	1.00	65	80.5	0.6	0.6				70.2	14.00	14.60
HS71912E.T.P4S	60	85	13	1.00	1.00	65	80.5	0.6	0.6				70.2	13.20	13.40
HC71912C.T.P4S	60	85	13	1.00	1.00	65	80.5	0.6	0.6	2.8	7.2	1.4	70.2	9.65	10.00
HC71912E.T.P4S	60	85	13	1.00	1.00	65	80.5	0.6	0.6	2.8	7.2	1.4	70.2	9.00	9.50
XC71912C.T.P4S	60	85	13	1.00	1.00	65	80.5	0.6	0.6	2.8	7.2	1.4	70.2	21.60	10.00
XC71912E.T.P4S	60	85	13	1.00	1.00	65	80.5	0.6	0.6	2.8	7.2	1.4	70.2	20.00	9.50
B7012C.T.P4S	60	95	18	1.10	1.10	67	88	1.0	0.6				73.1	39.00	33.50
B7012E.T.P4S	60	95	18	1.10	1.10	67	88	1.0	0.6				73.1	36.50	31.50
HCB7012C.T.P4S	60	95	18	1.10	1.10	67	88	1.0	0.6	4.3	9.7	1.4	73.1	27.00	23.20
HCB7012E.T.P4S	60	95	18	1.10	1.10	67	88	1.0	0.6	4.3	9.7	1.4	73.1	25.50	22.00
XCB7012C.T.P4S	60	95	18	1.10	1.10	67	88	1.0	0.6	4.3	9.7	1.4	73.1	60.00	23.20
XCB7012E.T.P4S	60	95	18	1.10	1.10	67	88	1.0	0.6	4.3	9.7	1.4	73.1	57.00	22.00
HS7012C.T.P4S	60	95	18	1.10	1.10	67	88	1.0	0.6				74.7	19.30	20.00
HS7012E.T.P4S	60	95	18	1.10	1.10	67	88	1.0	0.6				74.7	18.30	19.00
HC7012C.T.P4S	60	95	18	1.10	1.10	67	88	1.0	0.6	4.3	9.7	1.4	74.7	13.40	14.00
HC7012E.T.P4S	60	95	18	1.10	1.10	67	88	1.0	0.6	4.3	9.7	1.4	74.7	12.70	13.20
XC7012C.T.P4S	60	95	18	1.10	1.10	67	88	1.0	0.6	4.3	9.7	1.4	74.7	30.00	14.00
XC7012E.T.P4S	60	95	18	1.10	1.10	67	88	1.0	0.6	4.3	9.7	1.4	74.7	28.50	13.20
B7212C.T.P4S	60	110	22	1.50	1.50	69.5	101.5	1.5	1.5				81.2	55.00	44.00
B7212E.T.P4S	60	110	22	1.50	1.50	69.5	101.5	1.5	1.5				81.2	52.00	42.50
HCB7212C.T.P4S	60	110	22	1.50	1.50	69.5	101.5	1.5	1.5				81.2	38.00	30.50
HCB7212E.T.P4S	60	110	22	1.50	1.50	69.5	101.5	1.5	1.5				81.2	36.00	29.00
Designation examples:															
					Sealed design					Hybrid ceramic design					
					B7012C.2RSD.T.P4S.UL					HCB7012C.T.P4S.UL					
					HSS7012E.T.P4S.UL					HCB71812C.TPA.P4.UL					

SPINDLE BEARINGS

B718..C/E, B719, B70, B72 HS719..C/E, HS70

C: Contact Angle $\alpha = 15^\circ$ / E: Contact Angle $\alpha = 25^\circ$

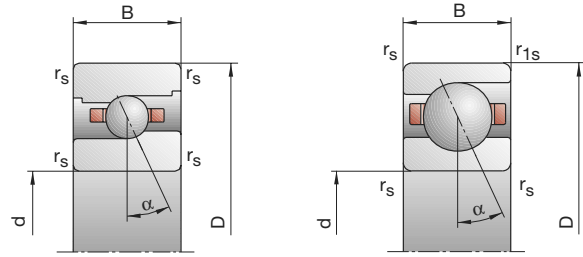

Attainable Speed Grease Oil minimal min ⁻¹	Preloading Force F_V			Unloading Force K_{aE}			Axial Rigidity S_a			Sealed Design	Weight kg	Bearing Code FAG	
	L	M	H	L	M	H	L	M	H				
16000	26000	51	200	435	153	654	1530	41.0	75.1	111.3	–	0.10	B71812C.TPA.P4
14000	22000	80	280	649	229	826	1985	99.6	159.2	223.9	–	0.10	B71812E.TPA.P4
20000	34000	24	112	258	71	352	860	34.6	64.3	94.4	–	0.10	HCB71812C.TPA.P4
17000	28000	41	145	370	118	424	1111	89.5	140.4	200.4	–	0.10	HCB71812E.TPA.P4
15000	24000	117	410	866	362	1376	3119	55.0	96.5	141.2	•	0.19	B71912C.T.P4S
14000	22000	156	622	1353	455	1879	4234	124.4	209.2	287.9	•	0.19	B71912E.T.P4S
19000	32000	54	215	470	163	690	1590	45.5	79.9	114.3	•	0.16	HCB71912C.T.P4S
17000	28000	57	302	707	167	903	2162	99.4	179.6	248.3	•	0.16	HCB71912E.T.P4S
26000	40000	54	215	470	163	690	1590	45.5	79.9	114.3	•	0.16	XCB71912C.T.P4S
22000	36000	57	302	707	167	903	2162	99.4	179.6	248.3	•	0.16	XCB71912E.T.P4S
19000	32000	48	145	289	143	454	949	39.8	62.8	86.2	•	0.21	HS71912C.T.P4S
17000	28000	78	235	469	224	688	1401	99.7	148.7	193.8	•	0.21	HS71912E.T.P4S
22000	36000	34	101	201	101	312	643	39.4	60.5	81.1	•	0.19	HC71912C.T.P4S
19000	32000	53	160	320	153	468	951	98.7	146.0	188.8	•	0.19	HC71912E.T.P4S
28000	43000	34	101	201	101	312	643	39.4	60.5	81.1	•	0.19	XC71912C.T.P4S
24000	38000	53	160	320	153	468	951	98.7	146.0	188.8	•	0.19	XC71912E.T.P4S
14000	22000	211	704	1459	658	2387	5310	64.5	111.7	162.8	•	0.40	B7012C.T.P4S
13000	20000	299	1075	2281	878	3263	7173	147.9	240.4	328.4	•	0.40	B7012E.T.P4S
18000	30000	105	378	801	320	1224	2743	54.7	93.0	132.0	•	0.34	HCB7012C.T.P4S
15000	24000	137	572	1263	402	1720	3885	127.0	213.0	289.0	•	0.34	HCB7012E.T.P4S
24000	38000	105	378	801	320	1224	2743	54.7	93.0	132.0	•	0.34	XCB7012C.T.P4S
20000	34000	137	572	1263	402	1720	3885	127.0	213.0	289.0	•	0.34	XCB7012E.T.P4S
18000	30000	67	201	402	200	630	1323	45.4	71.4	98.2	•	0.46	HS7012C.T.P4S
15000	24000	107	322	644	307	941	1921	112.7	168.1	219.3	•	0.46	HS7012E.T.P4S
20000	34000	46	139	279	136	429	895	44.2	68.5	92.4	•	0.43	HC7012C.T.P4S
18000	30000	75	225	451	217	660	1343	113.2	167.1	216.1	•	0.43	HC7012E.T.P4S
28000	43000	46	139	279	136	429	895	44.2	68.5	92.4	•	0.43	XC7012C.T.P4S
24000	38000	75	225	451	217	660	1343	113.2	167.1	216.1	•	0.43	XC7012E.T.P4S
13000	20000	315	1022	2100	986	3479	7697	71.4	122.8	178.8	•	0.80	B7212C.T.P4S
12000	19000	467	1599	3333	1374	4877	10509	165.9	265.8	360.8	•	0.80	B7212E.T.P4S
16000	26000	162	557	1164	496	1811	4002	61.3	102.7	145.2	•	0.70	HCB7212C.T.P4S
14000	22000	229	867	1866	674	2612	5767	145.8	236.5	318.7	•	0.70	HCB7212E.T.P4S

Direct-Lube design
HCB7012EDLR.T.P4S.UL
XC7012EDLR.T.P4S.UL

X-life ultra design
XC7012E.T.P4S.UL
XCB7012C.T.P4S.UL

See Bearing Code, page 178

SPINDLE BEARINGS

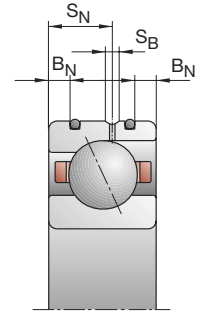
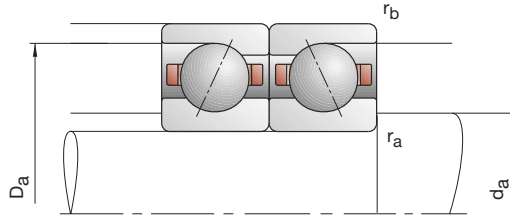
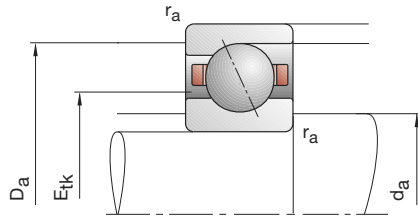

Bearing Code	Dimensions					Abutment Dimensions				DLR Dimensions			Load Ratings		
	d	D	B	r _{smin}	r _{1smin}	d _a h12	D _a H12	r _a max	r _b max	B _N	S _N	S _B	E _{tk}	C _{dyn}	C _{0stat}
FAG	mm													kN	
B71813C.TPA.P4	65	85	10	0.60	0.30	69	80.5	0.6	0.3				72.3	13.40	14.00
B71813E.TPA.P4	65	85	10	0.60	0.30	69	80.5	0.6	0.3				72.3	12.70	12.90
HCB71813C.TPA.P4	65	85	10	0.60	0.30	69	80.5	0.6	0.3				72.3	9.30	9.80
HCB71813E.TPA.P4	65	85	10	0.60	0.30	69	80.5	0.6	0.3				72.3	8.80	9.15
B71913C.T.P4S	65	90	13	1.00	1.00	70	85.5	0.6	0.6				75.1	24.50	24.00
B71913E.T.P4S	65	90	13	1.00	1.00	70	85.5	0.6	0.6				75.1	22.80	22.40
HCB71913C.T.P4S	65	90	13	1.00	1.00	70	85.5	0.6	0.6	2.8	7.2	1.4	75.1	17.00	16.60
HCB71913E.T.P4S	65	90	13	1.00	1.00	70	85.5	0.6	0.6	2.8	7.2	1.4	75.1	16.00	16.00
XCB71913C.T.P4S	65	90	13	1.00	1.00	70	85.5	0.6	0.6	2.8	7.2	1.4	75.1	38.00	16.60
XCB71913E.T.P4S	65	90	13	1.00	1.00	70	85.5	0.6	0.6	2.8	7.2	1.4	75.1	35.50	16.00
HS71913C.T.P4S	65	90	13	1.00	1.00	70	85.5	0.6	0.6				75.2	14.30	15.30
HS71913E.T.P4S	65	90	13	1.00	1.00	70	85.5	0.6	0.6				75.2	13.40	14.30
HC71913C.T.P4S	65	90	13	1.00	1.00	70	85.5	0.6	0.6	2.8	7.2	1.4	75.2	9.80	10.80
HC71913E.T.P4S	65	90	13	1.00	1.00	70	85.5	0.6	0.6	2.8	7.2	1.4	75.2	9.30	10.00
XC71913C.T.P4S	65	90	13	1.00	1.00	70	85.5	0.6	0.6	2.8	7.2	1.4	75.2	22.00	10.80
XC71913E.T.P4S	65	90	13	1.00	1.00	70	85.5	0.6	0.6	2.8	7.2	1.4	75.2	20.80	10.00
B7013C.T.P4S	65	100	18	1.10	1.10	72	93	1.0	0.6				78.1	40.00	35.50
B7013E.T.P4S	65	100	18	1.10	1.10	72	93	1.0	0.6				78.1	38.00	33.50
HCB7013C.T.P4S	65	100	18	1.10	1.10	72	93	1.0	0.6	4.0	10.4	1.4	78.1	27.50	24.50
HCB7013E.T.P4S	65	100	18	1.10	1.10	72	93	1.0	0.6	4.0	10.4	1.4	78.1	26.00	23.60
XCB7013C.T.P4S	65	100	18	1.10	1.10	72	93	1.0	0.6	4.0	10.4	1.4	78.1	61.00	24.50
XCB7013E.T.P4S	65	100	18	1.10	1.10	72	93	1.0	0.6	4.0	10.4	1.4	78.1	58.50	23.60
HS7013C.T.P4S	65	100	18	1.10	1.10	72	93	1.0	0.6				79.7	20.00	21.60
HS7013E.T.P4S	65	100	18	1.10	1.10	72	93	1.0	0.6				79.7	19.00	20.00
HC7013C.T.P4S	65	100	18	1.10	1.10	72	93	1.0	0.6	4.0	10.4	1.4	79.7	13.70	15.00
HC7013E.T.P4S	65	100	18	1.10	1.10	72	93	1.0	0.6	4.0	10.4	1.4	79.7	12.90	14.00
XC7013C.T.P4S	65	100	18	1.10	1.10	72	93	1.0	0.6	4.0	10.4	1.4	79.7	30.50	15.00
XC7013E.T.P4S	65	100	18	1.10	1.10	72	93	1.0	0.6	4.0	10.4	1.4	79.7	28.50	14.00
B7213C.T.P4S	65	120	23	1.50	1.50	75.5	109.5	1.5	1.5				88.2	57.00	48.00
B7213E.T.P4S	65	120	23	1.50	1.50	75.5	109.5	1.5	1.5				88.2	54.00	45.50
HCB7213C.T.P4S	65	120	23	1.50	1.50	75.5	109.5	1.5	1.5				88.2	40.00	23.60
HCB7213E.T.P4S	65	120	23	1.50	1.50	75.5	109.5	1.5	1.5				88.2	37.50	22.40
Designation examples:															
						Sealed design						Hybrid ceramic design			
						B7013C.2RSD.T.P4S.UL						HCB7013C.T.P4S.UL			
						HSS7013E.T.P4S.UL						HCB71813C.TPA.P4.UL			

SPINDLE BEARINGS

B718..C/E, B719, B70, B72 HS719..C/E, HS70

C: Contact Angle $\alpha = 15^\circ$ / E: Contact Angle $\alpha = 25^\circ$

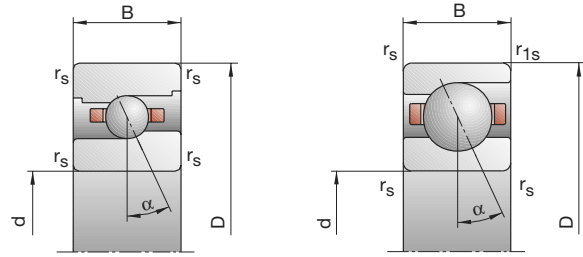

Attainable Speed	Grease	Oil minimal	Preloading Force F_V			Unloading Force K_{aE}			Axial Rigidity S_a			Sealed Design	Weight	Bearing Code
			L	M	H	L	M	H	L	M	H			
min ⁻¹			N			N/μm			kg				FAG	
15000	24000	51	201	440	154	660	1554	43.6	79.9	118.6	–	0.13	B71813C.TPA.P4	
13000	20000	82	289	673	236	857	2070	106.8	171.0	241.1	–	0.13	B71813E.TPA.P4	
19000	32000	24	116	267	71	366	895	36.6	69.1	101.6	–	0.13	HCB71813C.TPA.P4	
16000	26000	42	149	384	121	438	1160	95.5	150.5	215.8	–	0.13	HCB71813E.TPA.P4	
14000	22000	118	417	883	364	1396	3172	56.5	99.4	145.6	•	0.20	B71913C.T.P4S	
13000	20000	153	617	1348	447	1860	4207	127.1	214.0	294.5	•	0.20	B71913E.T.P4S	
18000	30000	55	219	479	166	702	1617	47.1	82.6	117.9	•	0.17	HCB71913C.T.P4S	
15000	24000	57	307	721	167	918	2203	102.3	185.7	256.8	•	0.17	HCB71913E.T.P4S	
24000	38000	55	219	479	166	702	1617	47.1	82.6	117.9	•	0.17	XCB71913C.T.P4S	
20000	34000	57	307	721	167	918	2203	102.3	185.7	256.8	•	0.17	XCB71913E.T.P4S	
18000	30000	49	147	295	145	459	965	41.6	65.6	90.0	•	0.23	HS71913C.T.P4S	
15000	24000	80	239	478	229	698	1426	104.6	155.7	203.1	•	0.23	HS71913E.T.P4S	
20000	34000	34	103	205	101	317	654	41.1	63.3	84.9	•	0.21	HC71913C.T.P4S	
18000	30000	55	166	331	159	486	983	104.4	154.4	199.1	•	0.21	HC71913E.T.P4S	
26000	43000	34	103	205	101	317	654	41.1	63.3	84.9	•	0.21	XC71913C.T.P4S	
24000	38000	55	166	331	159	486	983	104.4	154.4	199.1	•	0.21	XC71913E.T.P4S	
13000	20000	216	720	1495	672	2433	5422	67.1	116.1	169.1	•	0.42	B7013C.T.P4S	
12000	19000	310	1118	2372	910	3391	7452	155.1	252.3	344.4	•	0.42	B7013E.T.P4S	
17000	28000	109	391	830	332	1264	2837	57.4	97.3	138.1	•	0.36	HCB7013C.T.P4S	
15000	24000	137	579	1281	402	1739	3934	131.6	221.3	300.2	•	0.36	HCB7013E.T.P4S	
22000	36000	109	391	830	332	1264	2837	57.4	97.3	138.1	•	0.36	XCB7013C.T.P4S	
19000	32000	137	579	1281	402	1739	3934	131.6	221.3	300.2	•	0.36	XCB7013E.T.P4S	
17000	28000	70	209	418	208	654	1373	48.0	75.5	103.8	•	0.48	HS7013C.T.P4S	
15000	24000	112	336	672	321	981	2002	119.7	178.3	232.5	•	0.48	HS7013E.T.P4S	
20000	34000	47	142	284	139	438	907	46.6	72.0	96.7	•	0.45	HC7013C.T.P4S	
17000	28000	77	230	460	222	674	1367	119.2	176.0	227.1	•	0.45	HC7013E.T.P4S	
26000	40000	47	142	284	139	438	907	46.6	72.0	96.7	•	0.45	XC7013C.T.P4S	
22000	36000	77	230	460	222	674	1367	119.2	176.0	227.1	•	0.45	XC7013E.T.P4S	
12000	19000	325	1051	2163	1015	3565	7874	75.1	128.6	186.9	•	1.02	B7213C.T.P4S	
11000	18000	482	1656	3455	1417	5043	10873	174.9	280.1	380.1	•	1.02	B7213E.T.P4S	
15000	24000	170	580	1213	520	1882	4161	64.9	108.3	153.1	•	0.88	HCB7213C.T.P4S	
13000	20000	234	892	1918	688	2684	5918	153.2	248.9	334.9	•	0.88	HCB7213E.T.P4S	

Direct-Lube design

HCB7013EDLR.T.P4S.UL

XC7013EDLR.T.P4S.UL

X-life ultra design

XC7013E.T.P4S.UL

XCB7013C.T.P4S.UL

See Bearing Code, page 178

SPINDLE BEARINGS

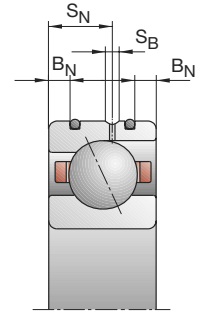
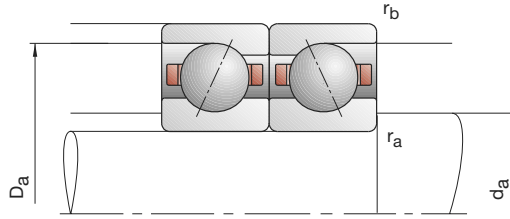
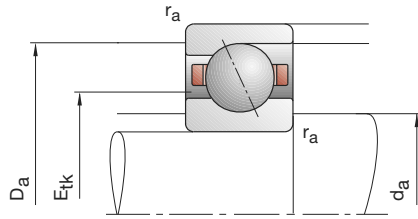

Bearing Code	Dimensions					Abutment Dimensions				DLR Dimensions			Load Ratings		
	d	D	B	r_{smin}	r_{1smin}	d_a h12	D_a H12	r_a max	r_b max	B_N	S_N	S_B	E_{tk}	Cdyn	C_{0stat}
FAG	mm													kN	
B71814C.TPA.P4	70	90	10	0.60	0.30	74	85.5	0.6	0.3				77.3	14.00	15.00
B71814E.TPA.P4	70	90	10	0.60	0.30	74	85.5	0.6	0.3				77.3	12.90	13.70
HCB71814C.TPA.P4	70	90	10	0.60	0.30	74	85.5	0.6	0.3				77.3	9.50	10.40
HCB71814E.TPA.P4	70	90	10	0.60	0.30	74	85.5	0.6	0.3				77.3	9.50	9.65
B71914C.T.P4S	70	100	16	1.00	1.00	76	94.5	0.6	0.6				82.2	33.50	32.50
B71914E.T.P4S	70	100	16	1.00	1.00	76	94.5	0.6	0.6				82.2	31.50	31.00
HCB71914C.T.P4S	70	100	16	1.00	1.00	76	94.5	0.6	0.6	3.1	9.3	1.4	82.2	23.20	22.80
HCB71914E.T.P4S	70	100	16	1.00	1.00	76	94.5	0.6	0.6	3.1	9.3	1.4	82.2	22.00	21.60
XCB71914C.T.P4S	70	100	16	1.00	1.00	76	94.5	0.6	0.6	3.1	9.3	1.4	82.2	52.00	22.80
XCB71914E.T.P4S	70	100	16	1.00	1.00	76	94.5	0.6	0.6	3.1	9.3	1.4	82.2	49.00	21.60
HS71914C.T.P4S	70	100	16	1.00	1.00	76	94.5	0.6	0.6				82.3	18.30	20.00
HS71914E.T.P4S	70	100	16	1.00	1.00	76	94.5	0.6	0.6				82.3	17.30	18.60
HC71914C.T.P4S	70	100	16	1.00	1.00	76	94.5	0.6	0.6	3.1	9.3	1.4	82.3	12.70	14.00
HC71914E.T.P4S	70	100	16	1.00	1.00	76	94.5	0.6	0.6	3.1	9.3	1.4	82.3	12.00	13.20
XC71914C.T.P4S	70	100	16	1.00	1.00	76	94.5	0.6	0.6	3.1	9.3	1.4	82.3	28.50	14.00
XC71914E.T.P4S	70	100	16	1.00	1.00	76	94.5	0.6	0.6	3.1	9.3	1.4	82.3	27.00	13.20
B7014C.T.P4S	70	110	20	1.10	1.10	77	102	1.0	0.6				85.0	50.00	43.00
B7014E.T.P4S	70	110	20	1.10	1.10	77	102	1.0	0.6				85.0	46.50	41.50
HCB7014C.T.P4S	70	110	20	1.10	1.10	77	102	1.0	0.6	4.0	11.6	1.4	85.0	34.00	30.00
HCB7014E.T.P4S	70	110	20	1.10	1.10	77	102	1.0	0.6	4.0	11.6	1.4	85.0	32.50	29.00
XCB7014C.T.P4S	70	110	20	1.10	1.10	77	102	1.0	0.6	4.0	11.6	1.4	85.0	76.50	30.00
XCB7014E.T.P4S	70	110	20	1.10	1.10	77	102	1.0	0.6	4.0	11.6	1.4	85.0	72.00	29.00
HS7014C.T.P4S	70	110	20	1.10	1.10	77	102	1.0	0.6				86.7	26.00	28.00
HS7014E.T.P4S	70	110	20	1.10	1.10	77	102	1.0	0.6				86.7	24.50	26.00
HC7014C.T.P4S	70	110	20	1.10	1.10	77	102	1.0	0.6	4.0	11.6	1.4	86.7	18.00	19.60
HC7014E.T.P4S	70	110	20	1.10	1.10	77	102	1.0	0.6	4.0	11.6	1.4	86.7	17.00	18.30
XC7014C.T.P4S	70	110	20	1.10	1.10	77	102	1.0	0.6	4.0	11.6	1.4	86.7	40.00	19.60
XC7014E.T.P4S	70	110	20	1.10	1.10	77	102	1.0	0.6	4.0	11.6	1.4	86.7	38.00	18.30
B7214C.T.P4S	70	125	24	1.50	1.50	80	115	1.5	1.5				92.7	69.50	58.50
B7214E.T.P4S	70	125	24	1.50	1.50	80	115	1.5	1.5				92.7	65.50	56.00
HCB7214C.T.P4S	70	125	24	1.50	1.50	80	115	1.5	1.5				92.7	48.00	40.50
HCB7214E.T.P4S	70	125	24	1.50	1.50	80	115	1.5	1.5				92.7	45.50	39.00
Designation examples:					Sealed design					Hybrid ceramic design					
					B7014C.2RSD.T.P4S.UL					HCB7014C.T.P4S.UL					
					HSS7014E.T.P4S.UL					HCB71814C.TPA.P4.UL					

SPINDLE BEARINGS

B718..C/E, B719, B70, B72 HS719..C/E, HS70

C: Contact Angle $\alpha = 15^\circ$ / E: Contact Angle $\alpha = 25^\circ$

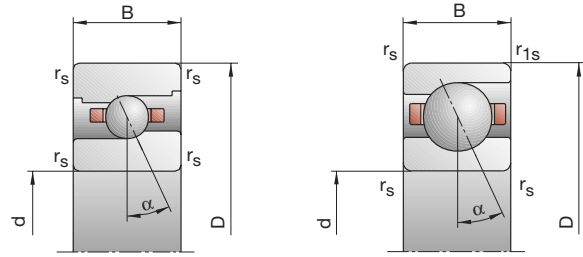

Attainable Speed	Grease	Oil minimal	Preloading Force			Unloading Force			Axial Rigidity			Sealed Design	Weight	Bearing Code
			F _V	L	M	H	K _{aE}	L	M	H	S _a			
min ⁻¹			N						N/μm			kg	FAG	
14000	22000		53	210	459	160	688	1617	46.1	84.4	125.2	–	0.14	B71814C.TPA.P4
13000	20000		81	289	678	233	855	2079	111.0	178.1	251.3	–	0.14	B71814E.TPA.P4
18000	30000		24	120	277	71	378	927	38.2	72.9	107.1	–	0.14	HCB71814C.TPA.P4
15000	24000		40	147	387	115	431	1166	97.9	156.1	225.3	–	0.14	HCB71814E.TPA.P4
13000	20000		172	588	1230	532	1970	4418	66.5	115.5	168.2	•	0.33	B71914C.T.P4S
12000	19000		234	890	1917	684	2691	5984	151.6	250.6	342.8	•	0.33	B71914E.T.P4S
16000	26000		82	311	671	248	997	2271	55.7	96.0	136.7	•	0.28	HCB71914C.T.P4S
14000	22000		96	452	1026	281	1351	3143	125.8	218.6	299.0	•	0.28	HCB71914E.T.P4S
22000	36000		82	311	671	248	997	2271	55.7	96.0	136.7	•	0.28	XCB71914C.T.P4S
18000	30000		96	452	1026	281	1351	3143	125.8	218.6	299.0	•	0.28	XCB71914E.T.P4S
16000	26000		64	192	383	190	600	1254	47.6	75.0	102.6	•	0.37	HS71914C.T.P4S
14000	22000		103	308	616	295	898	1833	119.0	176.9	230.7	•	0.37	HS71914E.T.P4S
19000	32000		44	131	263	131	403	839	46.9	71.5	96.3	•	0.35	HC71914C.T.P4S
16000	26000		71	214	428	205	626	1271	118.8	175.4	226.7	•	0.35	HC71914E.T.P4S
24000	40000		44	131	263	131	403	839	46.9	71.5	96.3	•	0.35	XC71914C.T.P4S
22000	36000		71	214	428	205	626	1271	118.8	175.4	226.7	•	0.35	XC71914E.T.P4S
12000	19000		278	915	1888	866	3095	6864	73.9	127.3	185.1	•	0.59	B7014C.T.P4S
11000	18000		398	1397	2945	1167	4242	9262	170.1	274.3	373.5	•	0.59	B7014E.T.P4S
16000	26000		140	492	1036	427	1590	3538	63.0	106.1	150.1	•	0.50	HCB7014C.T.P4S
13000	20000		184	736	1609	541	2208	4948	146.7	241.9	327.1	•	0.50	HCB7014E.T.P4S
20000	34000		140	492	1036	427	1590	3538	63.0	106.1	150.1	•	0.50	XCB7014C.T.P4S
17000	28000		184	736	1609	541	2208	4948	146.7	241.9	327.1	•	0.50	XCB7014E.T.P4S
16000	26000		89	268	536	265	837	1757	52.5	82.6	113.5	•	0.67	HS7014C.T.P4S
13000	20000		146	437	874	419	1277	2608	131.9	196.4	256.2	•	0.67	HS7014E.T.P4S
18000	30000		63	188	375	187	579	1202	52.0	79.8	107.4	•	0.63	HC7014C.T.P4S
15000	24000		101	304	607	292	892	1807	131.8	194.9	251.5	•	0.63	HC7014E.T.P4S
24000	38000		63	188	375	187	579	1202	52.0	79.8	107.4	•	0.63	XC7014C.T.P4S
20000	34000		101	304	607	292	892	1807	131.8	194.9	251.5	•	0.63	XC7014E.T.P4S
11000	18000		404	1301	2664	1264	4419	9712	83.8	143.2	207.6	•	1.12	B7214C.T.P4S
10000	17000		600	2030	4233	1765	6187	13319	194.9	310.5	421.0	•	1.12	B7214E.T.P4S
14000	22000		208	708	1477	635	2298	5066	71.8	119.8	169.0	•	0.96	HCB7214C.T.P4S
12000	19000		295	1101	2350	868	3315	7237	171.5	276.5	370.8	•	0.96	HCB7214E.T.P4S

Direct-Lube design
HCB7014EDLR.T.P4S.UL
XC7014EDLR.T.P4S.UL

X-life ultra design
XC7014E.T.P4S.UL
XCB7014C.T.P4S.UL

See Bearing Code, page 178

SPINDLE BEARINGS

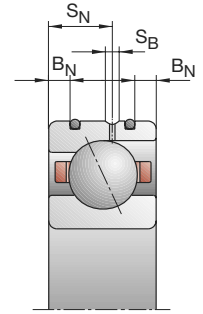
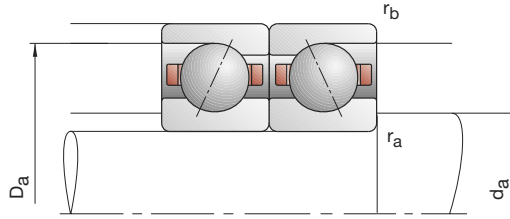
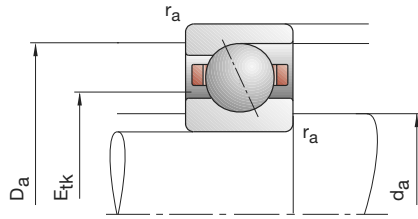

Bearing Code	Dimensions					Abutment Dimensions				DLR Dimensions			Load Ratings		
	d	D	B	r _{smin}	r _{1smin}	d _a h12	D _a H12	r _a max	r _b max	B _N	S _N	S _B	E _{tk}	C _{dyn}	C _{0stat}
FAG	mm													kN	
B71815C.TPA.P4	75	95	10	0.60	0.30	79	90.5	0.6	0.3				82.3	14.30	15.60
B71815E.TPA.P4	75	95	10	0.60	0.30	79	90.5	0.6	0.3				82.3	13.40	14.60
HCB71815C.TPA.P4	75	95	10	0.60	0.30	79	90.5	0.6	0.3				82.3	9.80	11.00
HCB71815E.TPA.P4	75	95	10	0.60	0.30	79	90.5	0.6	0.3				82.3	9.30	10.20
B71915C.T.P4S	75	105	16	1.00	1.00	81	99.5	0.6	0.6				87.2	34.00	34.50
B71915E.T.P4S	75	105	16	1.00	1.00	81	99.5	0.6	0.6				87.2	32.00	32.50
HCB71915C.T.P4S	75	105	16	1.00	1.00	81	99.5	0.6	0.6	3.1	9.3	1.4	87.2	23.60	24.00
HCB71915E.T.P4S	75	105	16	1.00	1.00	81	99.5	0.6	0.6	3.1	9.3	1.4	87.2	22.00	22.80
XCB71915C.T.P4S	75	105	16	1.00	1.00	81	99.5	0.6	0.6	3.1	9.3	1.4	87.2	53.00	24.00
XCB71915E.T.P4S	75	105	16	1.00	1.00	81	99.5	0.6	0.6	3.1	9.3	1.4	87.2	49.00	22.80
HS71915C.T.P4S	75	105	16	1.00	1.00	81	99.5	0.6	0.6				87.3	19.00	21.20
HS71915E.T.P4S	75	105	16	1.00	1.00	81	99.5	0.6	0.6				87.3	17.60	20.00
HC71915C.T.P4S	75	105	16	1.00	1.00	81	99.5	0.6	0.6	3.1	9.3	1.4	87.3	12.90	15.00
HC71915E.T.P4S	75	105	16	1.00	1.00	81	99.5	0.6	0.6	3.1	9.3	1.4	87.3	12.20	13.70
XC71915C.T.P4S	75	105	16	1.00	1.00	81	99.5	0.6	0.6	3.1	9.3	1.4	87.3	29.00	15.00
XC71915E.T.P4S	75	105	16	1.00	1.00	81	99.5	0.6	0.6	3.1	9.3	1.4	87.3	27.00	13.70
B7015C.T.P4S	75	115	20	1.10	1.10	82	107	1.0	0.6				90.0	51.00	46.50
B7015E.T.P4S	75	115	20	1.10	1.10	82	107	1.0	0.6				90.0	48.00	44.00
HCB7015C.T.P4S	75	115	20	1.10	1.10	82	107	1.0	0.6	4.0	11.6	1.4	90.0	35.50	32.50
HCB7015E.T.P4S	75	115	20	1.10	1.10	82	107	1.0	0.6	4.0	11.6	1.4	90.0	33.50	30.50
XCB7015C.T.P4S	75	115	20	1.10	1.10	82	107	1.0	0.6	4.0	11.6	1.4	90.0	80.00	32.50
XCB7015E.T.P4S	75	115	20	1.10	1.10	82	107	1.0	0.6	4.0	11.6	1.4	90.0	75.00	30.50
HS7015C.T.P4S	75	115	20	1.10	1.10	82	107	1.0	0.6				91.7	26.50	29.00
HS7015E.T.P4S	75	115	20	1.10	1.10	82	107	1.0	0.6				91.7	25.00	27.00
HC7015C.T.P4S	75	115	20	1.10	1.10	82	107	1.0	0.6	4.0	11.6	1.4	91.7	18.30	20.00
HC7015E.T.P4S	75	115	20	1.10	1.10	82	107	1.0	0.6	4.0	11.6	1.4	91.7	17.30	18.60
XC7015C.T.P4S	75	115	20	1.10	1.10	82	107	1.0	0.6	4.0	11.6	1.4	91.7	40.50	20.00
XC7015E.T.P4S	75	115	20	1.10	1.10	82	107	1.0	0.6	4.0	11.6	1.4	91.7	38.00	18.60
B7215C.T.P4S	75	130	25	1.50	1.50	85	120	1.5	1.5				97.7	72.00	63.00
B7215E.T.P4S	75	130	25	1.50	1.50	85	120	1.5	1.5				97.7	68.00	60.00
HCB7215C.T.P4S	75	130	25	1.50	1.50	85	120	1.5	1.5				97.7	50.00	44.00
HCB7215E.T.P4S	75	130	25	1.50	1.50	85	120	1.5	1.5				97.7	47.50	41.50
Designation examples:															
					Sealed design					Hybrid ceramic design					
					B7015C.2RSD.T.P4S.UL					HCB7015C.T.P4S.UL					
					HSS7015E.T.P4S.UL					HCB71815C.TPA.P4.UL					

SPINDLE BEARINGS

B718..C/E, B719, B70, B72 HS719..C/E, HS70

C: Contact Angle $\alpha = 15^\circ$ / E: Contact Angle $\alpha = 25^\circ$

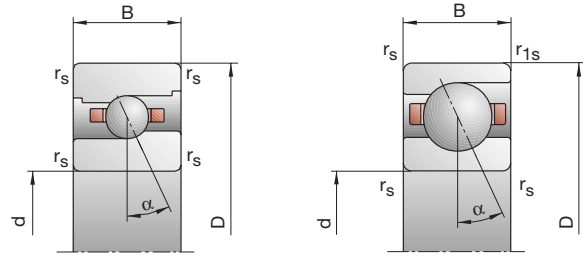

Attainable Speed Grease Oil minimal min ⁻¹	Preloading Force F _V			Unloading Force K _{aE}			Axial Rigidity S _a			Sealed Design	Weight kg	Bearing Code FAG	
	L	M	H	L	M	H	L	M	H				
13000	20000	53	213	467	159	695	1638	47.7	87.8	130.1	–	0.14	B71815C.TPA.P4
12000	19000	84	298	702	241	881	2150	116.8	187.3	264.5	–	0.14	B71815E.TPA.P4
16000	26000	24	120	280	71	377	933	39.8	75.6	111.2	–	0.14	HCB71815C.TPA.P4
14000	22000	41	148	392	118	434	1180	103.0	163.0	235.4	–	0.14	HCB71815E.TPA.P4
12000	19000	174	596	1246	537	1991	4460	68.5	118.8	172.7	•	0.35	B71915C.T.P4S
11000	18000	236	901	1943	689	2721	6055	156.2	258.3	353.3	•	0.35	B71915E.T.P4S
16000	26000	84	320	691	254	1025	2336	57.7	99.6	141.7	•	0.30	HCB71915C.T.P4S
13000	20000	96	457	1039	280	1365	3179	128.9	225.4	308.4	•	0.30	HCB71915E.T.P4S
20000	34000	84	320	691	254	1025	2336	57.7	99.6	141.7	•	0.30	XCB71915C.T.P4S
17000	28000	96	457	1039	280	1365	3179	128.9	225.4	308.4	•	0.30	XCB71915E.T.P4S
16000	26000	65	196	391	193	611	1276	49.8	78.3	107.0	•	0.40	HS71915C.T.P4S
13000	20000	105	315	630	301	918	1872	124.8	185.4	241.4	•	0.40	HS71915E.T.P4S
18000	30000	45	134	268	133	412	852	48.8	74.9	100.3	•	0.37	HC71915C.T.P4S
15000	24000	73	219	437	211	641	1297	125.0	184.1	237.4	•	0.37	HC71915E.T.P4S
23000	40000	45	134	268	133	412	852	48.8	74.9	100.3	•	0.37	XC71915C.T.P4S
19000	32000	73	219	437	211	641	1297	125.0	184.1	237.4	•	0.37	XC71915E.T.P4S
12000	19000	283	931	1923	880	3138	6964	76.8	131.9	191.7	•	0.62	B7015C.T.P4S
11000	18000	408	1439	3027	1196	4365	9505	177.7	286.7	389.8	•	0.62	B7015E.T.P4S
15000	24000	144	509	1071	439	1643	3650	65.9	111.0	156.8	•	0.53	HCB7015C.T.P4S
13000	20000	190	762	1667	557	2285	5122	153.6	253.5	342.7	•	0.53	HCB7015E.T.P4S
19000	32000	144	509	1071	439	1643	3650	65.9	111.0	156.8	•	0.53	XCB7015C.T.P4S
16000	26000	190	762	1667	557	2285	5122	153.6	253.5	342.7	•	0.53	XCB7015E.T.P4S
15000	24000	91	273	547	270	852	1790	54.0	85.0	116.7	•	0.71	HS7015C.T.P4S
13000	20000	148	444	888	425	1297	2647	135.8	201.9	263.2	•	0.71	HS7015E.T.P4S
17000	28000	63	188	375	187	578	1199	53.2	81.4	109.5	•	0.66	HC7015C.T.P4S
15000	24000	101	304	607	292	891	1805	134.9	199.2	257.0	•	0.66	HC7015E.T.P4S
22000	36000	63	188	375	187	578	1199	53.2	81.4	109.5	•	0.66	XC7015C.T.P4S
19000	32000	101	304	607	292	891	1805	134.9	199.2	257.0	•	0.66	XC7015E.T.P4S
11000	18000	416	1346	2757	1299	4560	10021	87.8	150.1	217.4	•	1.21	B7215C.T.P4S
9500	16000	619	2103	4389	1820	6402	13790	204.9	326.6	442.6	•	1.21	B7215E.T.P4S
14000	22000	215	733	1531	656	2375	5239	75.5	125.8	177.4	•	1.05	HCB7215C.T.P4S
12000	19000	306	1142	2439	900	3436	7503	180.6	291.2	390.2	•	1.05	HCB7215E.T.P4S

Direct-Lube design
HCB7015EDLR.T.P4S.UL
XC7015EDLR.T.P4S.UL

X-life ultra design
XC7015E.T.P4S.UL
XCB7015C.T.P4S.UL

See Bearing Code, page 178

SPINDLE BEARINGS

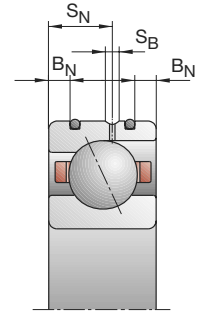
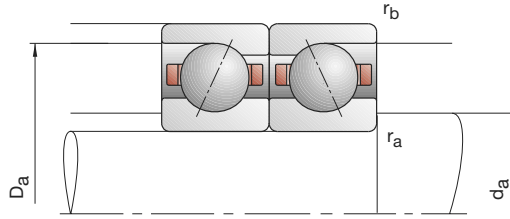
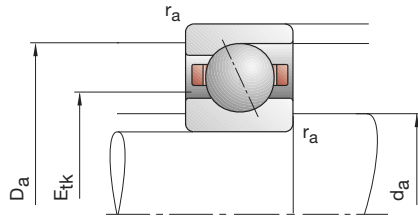

Bearing Code	Dimensions					Abutment Dimensions				DLR Dimensions			Load Ratings		
	d	D	B	r _{smin}	r _{1smin}	d _a h12	D _a H12	r _a max	r _b max	B _N	S _N	S _B	E _{tk}	C _{dyn}	C _{0stat}
FAG	mm													kN	
B71816C.TPA.P4	80	100	10	0.60	0.30	84	95.5	0.6	0.3				87.3	14.60	16.60
B71816E.TPA.P4	80	100	10	0.60	0.30	84	95.5	0.6	0.3				87.3	13.70	15.60
HCB71816C.TPA.P4	80	100	10	0.60	0.30	84	95.5	0.6	0.3				87.3	10.00	11.60
HCB71816E.TPA.P4	80	100	10	0.60	0.30	84	95.5	0.6	0.3				87.3	9.50	10.80
B71916C.T.P4S	80	110	16	1.00	1.00	86	104	0.6	0.6				92.2	34.50	36.00
B71916E.T.P4S	80	110	16	1.00	1.00	86	104	0.6	0.6				92.2	32.50	34.00
HCB71916C.T.P4S	80	110	16	1.00	1.00	86	104	0.6	0.6	3.1	9.3	1.4	92.2	24.00	25.00
HCB71916E.T.P4S	80	110	16	1.00	1.00	86	104	0.6	0.6	3.1	9.3	1.4	92.2	22.40	23.60
XCB71916C.T.P4S	80	110	16	1.00	1.00	86	104	0.6	0.6	3.1	9.3	1.4	92.2	54.00	25.00
XCB71916E.T.P4S	80	110	16	1.00	1.00	86	104	0.6	0.6	3.1	9.3	1.4	92.2	50.00	23.60
HS71916C.T.P4S	80	110	16	1.00	1.00	86	104	0.6	0.6				92.2	21.20	24.00
HS71916E.T.P4S	80	110	16	1.00	1.00	86	104	0.6	0.6				92.2	19.60	22.40
HC71916C.T.P4S	80	110	16	1.00	1.00	86	104	0.6	0.6	3.1	9.3	1.4	92.2	14.60	16.60
HC71916E.T.P4S	80	110	16	1.00	1.00	86	104	0.6	0.6	3.1	9.3	1.4	92.2	13.70	15.60
XC71916C.T.P4S	80	110	16	1.00	1.00	86	104	0.6	0.6	3.1	9.3	1.4	92.2	32.50	16.60
XC71916E.T.P4S	80	110	16	1.00	1.00	86	104	0.6	0.6	3.1	9.3	1.4	92.2	30.50	15.60
B7016C.T.P4S	80	125	22	1.10	1.10	88	117	1.0	0.6				96.8	63.00	58.50
B7016E.T.P4S	80	125	22	1.10	1.10	88	117	1.0	0.6				96.8	60.00	55.00
HCB7016C.T.P4S	80	125	22	1.10	1.10	88	117	1.0	0.6	4.7	12.2	2.2	96.8	44.00	40.50
HCB7016E.T.P4S	80	125	22	1.10	1.10	88	117	1.0	0.6	4.7	12.2	2.2	96.8	41.50	39.00
XCB7016C.T.P4S	80	125	22	1.10	1.10	88	117	1.0	0.6	4.7	12.2	2.2	96.8	98.00	40.50
XCB7016E.T.P4S	80	125	22	1.10	1.10	88	117	1.0	0.6	4.7	12.2	2.2	96.8	93.00	39.00
HS7016C.T.P4S	80	125	22	1.10	1.10	88	117	1.0	0.6				98.9	31.50	34.50
HS7016E.T.P4S	80	125	22	1.10	1.10	88	117	1.0	0.6				98.9	30.00	32.50
HC7016C.T.P4S	80	125	22	1.10	1.10	88	117	1.0	0.6	4.7	12.2	2.2	98.9	21.60	24.50
HC7016E.T.P4S	80	125	22	1.10	1.10	88	117	1.0	0.6	4.7	12.2	2.2	98.9	20.40	22.80
XC7016C.T.P4S	80	125	22	1.10	1.10	88	117	1.0	0.6	4.7	12.2	2.2	98.9	48.00	24.50
XC7016E.T.P4S	80	125	22	1.10	1.10	88	117	1.0	0.6	4.7	12.2	2.2	98.9	45.50	22.80
B7216C.T.P4S	80	140	26	2.00	2.00	91	129	2.0	2.0				104.3	93.00	78.00
B7216E.T.P4S	80	140	26	2.00	2.00	91	129	2.0	2.0				104.3	88.00	73.50
HCB7216C.T.P4S	80	140	26	2.00	2.00	91	129	2.0	2.0				104.3	64.00	54.00
HCB7216E.T.P4S	80	140	26	2.00	2.00	91	129	2.0	2.0				104.3	61.00	51.00
Designation examples:															
					Sealed design					Hybrid ceramic design					
					B7016C.2RSD.T.P4S.UL					HCB7016C.T.P4S.UL					
					HSS7016E.T.P4S.UL					HCB71816C.TPA.P4.UL					

SPINDLE BEARINGS

B718..C/E, B719, B70, B72 HS719..C/E, HS70

C: Contact Angle $\alpha = 15^\circ$ / E: Contact Angle $\alpha = 25^\circ$

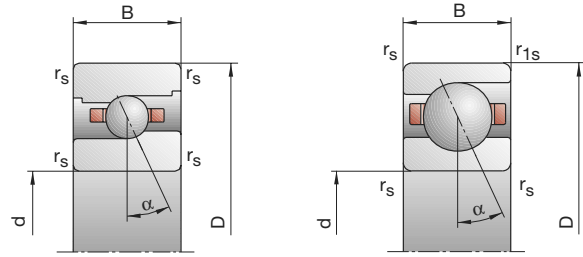

Attainable Speed	Grease	Oil minimal	Preloading Force F_V			Unloading Force K_{aE}			Axial Rigidity S_a			Sealed Design	Weight	Bearing Code
			L	M	H	L	M	H	L	M	H			
min ⁻¹			N			N/μm			N/μm			kg	FAG	
12000	19000		53	216	474	159	703	1655	49.5	91.2	134.9	–	0.15	B71816C.TPA.P4
11000	18000		84	302	712	241	892	2176	121.4	195.3	275.3	–	0.15	B71816E.TPA.P4
16000	26000		23	121	282	68	379	935	40.7	78.4	115.0	–	0.15	HCB71816C.TPA.P4
13000	20000		41	152	402	118	445	1208	107.1	170.7	246.3	–	0.15	HCB71816E.TPA.P4
12000	19000		175	603	1262	539	2009	4504	70.3	122.0	177.2	•	0.37	B71916C.T.P4S
11000	18000		238	911	1969	695	2748	6127	160.9	266.0	363.7	•	0.37	B71916E.T.P4S
15000	24000		83	319	689	251	1019	2320	59.0	101.8	144.5	•	0.31	HCB71916C.T.P4S
13000	20000		96	462	1052	280	1379	3215	132.5	232.3	317.6	•	0.31	HCB71916E.T.P4S
19000	32000		83	319	689	251	1019	2320	59.0	101.8	144.5	•	0.31	XCB71916C.T.P4S
16000	26000		96	462	1052	280	1379	3215	132.5	232.3	317.6	•	0.31	XCB71916E.T.P4S
15000	24000		73	218	437	217	679	1425	52.9	82.6	113.1	•	0.41	HS71916C.T.P4S
13000	20000		117	352	704	335	1026	2092	131.8	196.3	255.6	•	0.41	HS71916E.T.P4S
17000	28000		50	150	300	148	461	954	51.7	79.3	106.3	•	0.38	HC71916C.T.P4S
15000	24000		81	244	488	234	714	1448	132.0	194.7	251.1	•	0.38	HC71916E.T.P4S
22000	36000		50	150	300	148	461	954	51.7	79.3	106.3	•	0.38	XC71916C.T.P4S
19000	32000		81	244	488	234	714	1448	132.0	194.7	251.1	•	0.38	XC71916E.T.P4S
11000	18000		357	1163	2391	1110	3920	8635	86.3	147.5	213.5	•	0.84	B7016C.T.P4S
9500	16000		529	1830	3825	1552	5557	11989	201.7	323.3	437.9	•	0.84	B7016E.T.P4S
14000	22000		185	643	1345	564	2077	4585	74.5	124.8	175.8	•	0.71	HCB7016C.T.P4S
12000	19000		250	967	2089	734	2902	6423	175.2	285.5	384.2	•	0.71	HCB7016E.T.P4S
18000	30000		185	643	1345	564	2077	4585	74.5	124.8	175.8	•	0.71	XCB7016C.T.P4S
15000	24000		250	967	2089	734	2902	6423	175.2	285.5	384.2	•	0.71	XCB7016E.T.P4S
14000	22000		109	328	657	323	1024	2150	59.1	93.2	127.9	•	0.96	HS7016C.T.P4S
12000	19000		175	524	1049	502	1530	3127	147.9	220.0	287.0	•	0.96	HS7016E.T.P4S
16000	26000		74	222	445	219	682	1418	57.7	88.7	119.3	•	0.89	HC7016C.T.P4S
13000	20000		123	368	736	355	1079	2185	148.4	219.2	282.8	•	0.89	HC7016E.T.P4S
20000	34000		74	222	445	219	682	1418	57.7	88.7	119.3	•	0.89	XC7016C.T.P4S
17000	28000		123	368	736	355	1079	2185	148.4	219.2	282.8	•	0.89	XC7016E.T.P4S
10000	17000		553	1761	3602	1730	5976	13149	94.8	161.2	233.8	–	1.47	B7216C.T.P4S
9000	15000		839	2783	5750	2474	8475	18117	222.2	351.3	475.0	–	1.47	B7216E.T.P4S
12000	19000		290	964	1992	888	3127	6823	81.9	135.2	190.0	–	1.21	HCB7216C.T.P4S
11000	18000		423	1511	3197	1247	4558	9859	197.1	313.2	418.6	–	1.21	HCB7216E.T.P4S

Direct-Lube design
HCB7016EDLR.T.P4S.UL
XC7016EDLR.T.P4S.UL

X-life ultra design
XC7016E.T.P4S.UL
XCB7016C.T.P4S.UL

See Bearing Code, page 178

SPINDLE BEARINGS

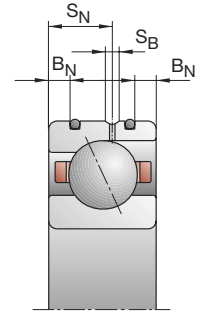
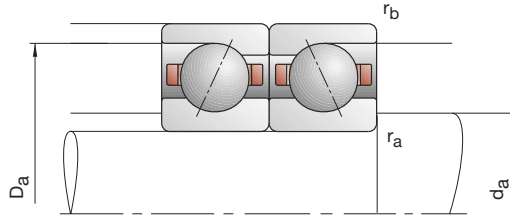
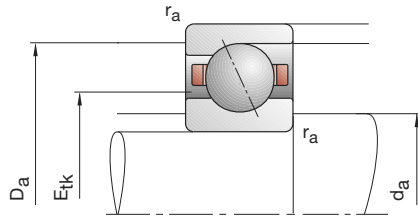

Bearing Code	Dimensions					Abutment Dimensions				DLR Dimensions			Load Ratings		
	d	D	B	r _{smin}	r _{1smin}	d _a h12	D _a H12	r _a max	r _b max	B _N	S _N	S _B	E _{tk}	C _{dyn}	C _{0stat}
FAG	mm													kN	
B71817C.TPA.P4	85	110	13	1.00	0.30	90	104.5	1.0	0.3				94.1	21.60	24.00
B71817E.TPA.P4	85	110	13	1.00	0.30	90	104.5	1.0	0.3				94.1	20.40	22.40
HCB71817C.TPA.P4	85	110	13	1.00	0.30	90	104.5	1.0	0.3				94.1	15.00	16.60
HCB71817E.TPA.P4	85	110	13	1.00	0.30	90	104.5	1.0	0.3				94.1	14.00	15.60
B71917C.T.P4S	85	120	18	1.10	1.10	92	114	0.6	0.6				99.2	45.00	46.50
B71917E.T.P4S	85	120	18	1.10	1.10	92	114	0.6	0.6				99.2	42.50	44.00
HCB71917C.T.P4S	85	120	18	1.10	1.10	92	114	0.6	0.6	4.0	10.4	2.2	99.2	31.00	32.50
HCB71917E.T.P4S	85	120	18	1.10	1.10	92	114	0.6	0.6	4.0	10.4	2.2	99.2	29.00	30.50
XCB71917C.T.P4S	85	120	18	1.10	1.10	92	114	0.6	0.6	4.0	10.4	2.2	99.2	69.50	32.50
XCB71917E.T.P4S	85	120	18	1.10	1.10	92	114	0.6	0.6	4.0	10.4	2.2	99.2	64.00	30.50
HS71917C.T.P4S	85	120	18	1.10	1.10	92	114	0.6	0.6				99.7	22.00	26.00
HS71917E.T.P4S	85	120	18	1.10	1.10	92	114	0.6	0.6				99.7	20.40	24.50
HC71917C.T.P4S	85	120	18	1.10	1.10	92	114	0.6	0.6	4.0	10.4	2.2	99.7	15.00	18.00
HC71917E.T.P4S	85	120	18	1.10	1.10	92	114	0.6	0.6	4.0	10.4	2.2	99.7	14.30	17.00
XC71917C.T.P4S	85	120	18	1.10	1.10	92	114	0.6	0.6	4.0	10.4	2.2	99.7	33.50	18.00
XC71917E.T.P4S	85	120	18	1.10	1.10	92	114	0.6	0.6	4.0	10.4	2.2	99.7	32.00	17.00
B7017C.T.P4S	85	130	22	1.10	1.10	93	122	1.0	0.6				101.8	65.50	62.00
B7017E.T.P4S	85	130	22	1.10	1.10	93	122	1.0	0.6				101.8	62.00	58.50
HCB7017C.T.P4S	85	130	22	1.10	1.10	93	122	1.0	0.6	4.7	12.2	2.2	101.8	45.00	43.00
HCB7017E.T.P4S	85	130	22	1.10	1.10	93	122	1.0	0.6	4.7	12.2	2.2	101.8	42.50	40.50
XCB7017C.T.P4S	85	130	22	1.10	1.10	93	122	1.0	0.6	4.7	12.2	2.2	101.8	100.00	43.00
XCB7017E.T.P4S	85	130	22	1.10	1.10	93	122	1.0	0.6	4.7	12.2	2.2	101.8	95.00	40.50
HS7017C.T.P4S	85	130	22	1.10	1.10	93	122	1.0	0.6				103.9	32.00	36.00
HS7017E.T.P4S	85	130	22	1.10	1.10	93	122	1.0	0.6				103.9	30.00	33.50
HC7017C.T.P4S	85	130	22	1.10	1.10	93	122	1.0	0.6	4.7	12.2	2.2	103.9	22.00	25.00
HC7017E.T.P4S	85	130	22	1.10	1.10	93	122	1.0	0.6	4.7	12.2	2.2	103.9	20.80	23.20
XC7017C.T.P4S	85	130	22	1.10	1.10	93	122	1.0	0.6	4.7	12.2	2.2	103.9	49.00	25.00
XC7017E.T.P4S	85	130	22	1.10	1.10	93	122	1.0	0.6	4.7	12.2	2.2	103.9	46.50	23.20
B7217C.T.P4S	85	150	28	2.00	2.00	98	138	2.0	2.0				112.3	96.50	85.00
B7217E.T.P4S	85	150	28	2.00	2.00	98	138	2.0	2.0				112.3	91.50	80.00
HCB7217C.T.P4S	85	150	28	2.00	2.00	98	138	2.0	2.0				112.3	67.00	58.50
HCB7217E.T.P4S	85	150	28	2.00	2.00	98	138	2.0	2.0				112.3	63.00	56.00
Designation examples:															
						Sealed design					Hybrid ceramic design				
						B7017C.2RSD.T.P4S.UL					HCB7017C.T.P4S.UL				
						HSS7017E.T.P4S.UL					HCB71817C.TPA.P4.UL				

SPINDLE BEARINGS

B718..C/E, B719, B70, B72 HS719..C/E, HS70

C: Contact Angle $\alpha = 15^\circ$ / E: Contact Angle $\alpha = 25^\circ$

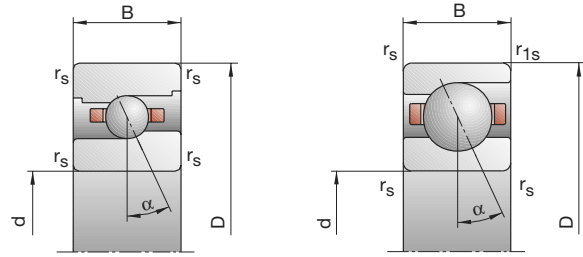

Attainable Speed Grease Oil minimal min ⁻¹	Preloading Force F _V			Unloading Force K _{aE}			Axial Rigidity S _a			Sealed Design	Weight kg	Bearing Code FAG	
	L	M	H	L	M	H	L	M	H				
11000	18000	93	344	739	281	1129	2603	59.5	106.2	156.2	–	0.27	B71817C.TPA.P4
10000	17000	113	507	1142	325	1508	3507	131.7	230.0	319.4	–	0.27	B71817E.TPA.P4
14000	22000	48	205	457	143	650	1532	51.8	93.4	135.2	–	0.27	HCB71817C.TPA.P4
12000	19000	89	279	678	258	823	2048	137.5	207.1	290.5	–	0.27	HCB71817E.TPA.P4
11000	18000	239	804	1672	739	2687	5982	80.3	138.0	200.0	•	0.53	B71917C.T.P4S
9500	16000	336	1232	2631	983	3716	8205	185.3	301.8	411.4	•	0.53	B71917E.T.P4S
13000	20000	120	438	934	363	1405	3160	68.6	116.5	164.9	•	0.45	HCB71917C.T.P4S
12000	19000	148	642	1436	433	1921	4389	157.3	266.2	361.7	•	0.45	HCB71917E.T.P4S
18000	30000	120	438	934	363	1405	3160	68.6	116.5	164.9	•	0.45	XCB71917C.T.P4S
15000	24000	148	642	1436	433	1921	4389	157.3	266.2	361.7	•	0.45	XCB71917E.T.P4S
14000	22000	76	228	456	225	708	1482	56.4	88.3	120.7	•	0.61	HS71917C.T.P4S
12000	19000	123	368	736	352	1071	2184	141.7	210.4	273.8	•	0.61	HS71917E.T.P4S
16000	26000	53	158	316	157	485	1003	55.8	85.2	114.0	•	0.57	HC71917C.T.P4S
13000	20000	84	253	506	242	739	1499	140.9	208.0	268.3	•	0.57	HC71917E.T.P4S
20000	34000	53	158	316	157	485	1003	55.8	85.2	114.0	•	0.57	XC71917C.T.P4S
17000	28000	84	253	506	242	739	1499	140.9	208.0	268.3	•	0.57	XC71917E.T.P4S
10000	17000	370	1209	2484	1150	4070	8957	90.3	154.3	223.1	•	0.89	B7017C.T.P4S
9000	15000	545	1888	3949	1598	5728	12364	210.6	337.5	457.1	•	0.89	B7017E.T.P4S
13000	20000	192	667	1401	585	2152	4772	78.0	130.5	184.1	•	0.74	HCB7017C.T.P4S
11000	18000	260	1008	2179	763	3024	6697	183.6	299.5	402.9	•	0.74	HCB7017E.T.P4S
17000	28000	192	667	1401	585	2152	4772	78.0	130.5	184.1	•	0.74	XCB7017C.T.P4S
14000	22000	260	1008	2179	763	3024	6697	183.6	299.5	402.9	•	0.74	XCB7017E.T.P4S
13000	20000	109	328	657	323	1022	2144	60.5	95.1	130.2	•	0.99	HS7017C.T.P4S
11000	18000	178	534	1067	509	1559	3178	151.9	226.4	294.9	•	0.99	HS7017E.T.P4S
15000	24000	76	228	456	225	700	1452	59.6	91.5	122.9	•	0.92	HC7017C.T.P4S
13000	20000	123	368	736	355	1079	2183	151.8	224.1	288.9	•	0.93	HC7017E.T.P4S
19000	32000	76	228	456	225	700	1452	59.6	91.5	122.9	•	0.92	XC7017C.T.P4S
16000	26000	123	368	736	355	1079	2183	151.8	224.1	288.9	•	0.93	XC7017E.T.P4S
9000	15000	573	1825	3734	1789	6176	13586	99.8	169.5	245.6	–	1.85	B7217C.T.P4S
8000	13000	869	2889	5972	2554	8786	18785	234.3	370.6	500.9	–	1.85	B7217E.T.P4S
11000	18000	301	999	2066	920	3234	7057	86.4	142.4	199.8	–	1.58	HCB7217C.T.P4S
10000	17000	437	1567	3319	1287	4722	10222	207.8	330.5	441.6	–	1.58	HCB7217E.T.P4S

Direct-Lube design

HCB7017EDLR.T.P4S.UL

XC7017EDLR.T.P4S.UL

X-life ultra design

XC7017E.T.P4S.UL

XCB7017C.T.P4S.UL

See Bearing Code, page 178

SPINDLE BEARINGS

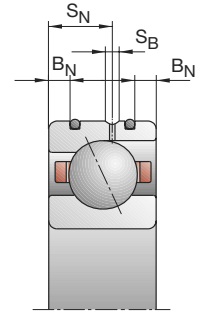
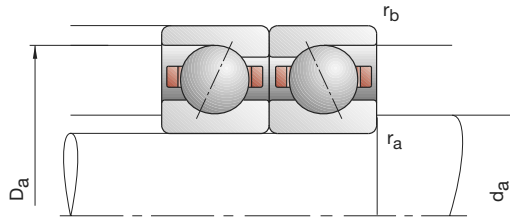
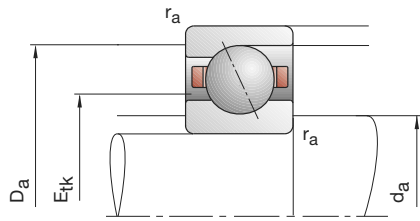

Bearing Code	Dimensions					Abutment Dimensions				DLR Dimensions			Load Ratings		
	d	D	B	r _{smin}	r _{1smin}	d _a	D _a	r _a	r _b	B _N	S _N	S _B	E _{tk}	C _{dyn}	C _{0stat}
FAG	mm														
B71818C.TPA.P4	90	115	13	1.00	0.30	95	109.5	1.0	0.3				99.4	21.20	23.60
B71818E.TPA.P4	90	115	13	1.00	0.30	95	109.5	1.0	0.3				99.4	20.00	22.00
HCB71818C.TPA.P4	90	115	13	1.00	0.30	95	109.5	1.0	0.3				99.4	14.60	16.60
HCB71818E.TPA.P4	90	115	13	1.00	0.30	95	109.5	1.0	0.3				99.4	14.00	15.30
B71918C.T.P4S	90	125	18	1.10	1.10	97	119	0.6	0.6				104.2	45.50	49.00
B71918E.T.P4S	90	125	18	1.10	1.10	97	119	0.6	0.6				104.2	43.00	46.50
HCB71918C.T.P4S	90	125	18	1.10	1.10	97	119	0.6	0.6	4.0	10.4	2.2	104.2	31.50	34.00
HCB71918E.T.P4S	90	125	18	1.10	1.10	97	119	0.6	0.6	4.0	10.4	2.2	104.2	30.00	32.00
XCB71918C.T.P4S	90	125	18	1.10	1.10	97	119	0.6	0.6	4.0	10.4	2.2	104.2	71.00	34.00
XCB71918E.T.P4S	90	125	18	1.10	1.10	97	119	0.6	0.6	4.0	10.4	2.2	104.2	67.00	32.00
HS71918C.T.P4S	90	125	18	1.10	1.10	97	119	0.6	0.6				104.5	23.60	28.50
HS71918E.T.P4S	90	125	18	1.10	1.10	97	119	0.6	0.6				104.5	22.40	26.50
HC71918C.T.P4S	90	125	18	1.10	1.10	97	119	0.6	0.6	4.0	10.4	2.2	104.5	16.30	19.60
HC71918E.T.P4S	90	125	18	1.10	1.10	97	119	0.6	0.6	4.0	10.4	2.2	104.5	15.60	18.60
XC71918C.T.P4S	90	125	18	1.10	1.10	97	119	0.6	0.6	4.0	10.4	2.2	104.5	36.50	19.60
XC71918E.T.P4S	90	125	18	1.10	1.10	97	119	0.6	0.6	4.0	10.4	2.2	104.5	34.50	18.60
B7018C.T.P4S	90	140	24	1.50	1.50	100	131	1.5	0.6				108.6	76.50	72.00
B7018E.T.P4S	90	140	24	1.50	1.50	100	131	1.5	0.6				108.6	72.00	68.00
HCB7018C.T.P4S	90	140	24	1.50	1.50	100	131	1.5	0.6	5.5	14.5	2.2	108.6	53.00	50.00
HCB7018E.T.P4S	90	140	24	1.50	1.50	100	131	1.5	0.6	5.5	14.5	2.2	108.6	50.00	47.50
XCB7018C.T.P4S	90	140	24	1.50	1.50	100	131	1.5	0.6	5.5	14.5	2.2	108.6	118.00	50.00
XCB7018E.T.P4S	90	140	24	1.50	1.50	100	131	1.5	0.6	5.5	14.5	2.2	108.6	112.00	47.50
HS7018C.T.P4S	90	140	24	1.50	1.50	100	131	1.5	0.6				111.0	37.50	43.00
HS7018E.T.P4S	90	140	24	1.50	1.50	100	131	1.5	0.6				111.0	35.50	40.00
HC7018C.T.P4S	90	140	24	1.50	1.50	100	131	1.5	0.6	5.5	14.5	2.2	111.0	26.00	30.00
HC7018E.T.P4S	90	140	24	1.50	1.50	100	131	1.5	0.6	5.5	14.5	2.2	111.0	24.50	28.00
XC7018C.T.P4S	90	140	24	1.50	1.50	100	131	1.5	0.6	5.5	14.5	2.2	111.0	58.50	30.00
XC7018E.T.P4S	90	140	24	1.50	1.50	100	131	1.5	0.6	5.5	14.5	2.2	111.0	55.00	28.00
B7218C.T.P4S	90	160	30	2.00	2.00	104	147	2.0	2.0				118.8	122.00	104.00
B7218E.T.P4S	90	160	30	2.00	2.00	104	147	2.0	2.0				118.8	116.00	100.00
HCB7218C.T.P4S	90	160	30	2.00	2.00	104	147	2.0	2.0				118.8	85.00	73.50
HCB7218E.T.P4S	90	160	30	2.00	2.00	104	147	2.0	2.0				118.8	80.00	69.50
Designation examples:															
					Sealed design					Hybrid ceramic design					
					B7018C.2RSD.T.P4S.UL					HCB7018C.T.P4S.UL					
					HSS7018E.T.P4S.UL					HCB71818C.TPA.P4.UL					

SPINDLE BEARINGS

B718..C/E, B719, B70, B72 HS719..C/E, HS70

C: Contact Angle $\alpha = 15^\circ$ / E: Contact Angle $\alpha = 25^\circ$

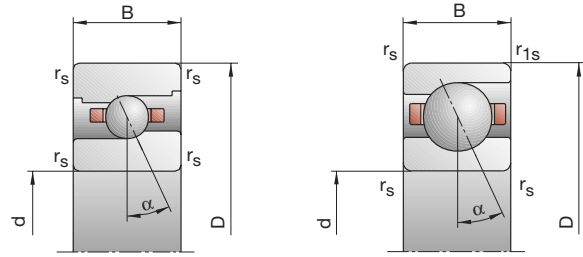

Attainable Speed Grease Oil minimal min ⁻¹	Preloading Force F _V			Unloading Force K _{aE}			Axial Rigidity S _a			Sealed Design	Weight kg	Bearing Code FAG	
	L	M	H	L	M	H	L	M	H				
11000	18000	91	337	724	275	1104	2544	59.0	105.2	154.5	–	0.28	B71818C.TPA.P4
9500	16000	110	495	1116	316	1471	3423	130.4	227.8	316.3	–	0.28	B71818E.TPA.P4
14000	22000	47	200	446	140	633	1496	51.4	92.4	133.8	–	0.28	HCB71818C.TPA.P4
12000	19000	79	271	659	228	799	1989	131.5	205.0	287.4	–	0.28	HCB71818E.TPA.P4
10000	17000	240	811	1688	740	2703	6019	82.3	141.6	204.9	•	0.55	B71918C.T.P4S
9000	15000	337	1243	2655	985	3745	8266	190.3	310.5	422.9	•	0.55	B71918E.T.P4S
13000	20000	122	445	950	369	1425	3207	70.9	120.1	169.8	•	0.47	HCB71918C.T.P4S
11000	18000	149	653	1461	436	1953	4461	162.0	274.9	373.3	•	0.47	HCB71918E.T.P4S
17000	28000	122	445	950	369	1425	3207	70.9	120.1	169.8	•	0.47	XCB71918C.T.P4S
14000	22000	149	653	1461	436	1953	4461	162.0	274.9	373.3	•	0.47	XCB71918E.T.P4S
13000	20000	83	249	498	246	772	1620	58.2	91.0	124.5	•	0.63	HS71918C.T.P4S
11000	18000	133	398	796	381	1158	2362	145.7	216.0	281.2	•	0.63	HS71918E.T.P4S
15000	24000	57	170	340	168	520	1078	56.9	87.1	116.7	•	0.58	HC71918C.T.P4S
13000	20000	92	276	552	265	807	1636	145.3	214.5	276.5	•	0.58	HC71918E.T.P4S
19000	32000	57	170	340	168	520	1078	56.9	87.1	116.7	•	0.58	XC71918C.T.P4S
16000	26000	92	276	552	265	807	1636	145.3	214.5	276.5	•	0.58	XC71918E.T.P4S
9500	16000	440	1427	2925	1369	4810	10569	95.8	163.5	236.2	•	1.15	B7018C.T.P4S
8500	14000	649	2217	4623	1905	6732	14476	223.6	356.6	482.2	•	1.15	B7018E.T.P4S
12000	19000	227	775	1622	691	2501	5523	82.6	137.2	193.2	•	0.96	HCB7018C.T.P4S
10000	17000	319	1207	2585	937	3625	7934	196.9	318.6	427.0	•	0.96	HCB7018E.T.P4S
15000	24000	227	775	1622	691	2501	5523	82.6	137.2	193.2	•	0.96	XCB7018C.T.P4S
13000	20000	319	1207	2585	937	3625	7934	196.9	318.6	427.0	•	0.96	XCB7018E.T.P4S
12000	19000	130	389	777	386	1212	2536	66.1	103.5	141.6	•	1.31	HS7018C.T.P4S
10000	17000	207	621	1242	592	1813	3689	164.4	244.9	318.6	•	1.31	HS7018E.T.P4S
14000	22000	89	268	536	264	823	1706	64.7	99.3	133.3	•	1.22	HC7018C.T.P4S
12000	19000	146	437	874	422	1278	2593	165.7	244.0	314.9	•	1.22	HC7018E.T.P4S
18000	30000	89	268	536	264	823	1706	64.7	99.3	133.3	•	1.22	XC7018C.T.P4S
15000	24000	146	437	874	422	1278	2593	165.7	244.0	314.9	•	1.22	XC7018E.T.P4S
8500	14000	738	2332	4746	2308	7904	17237	109.7	185.7	267.8	–	2.26	B7218C.T.P4S
7500	12000	1136	3717	7651	3343	11322	24113	258.6	406.9	549.2	–	2.26	B7218E.T.P4S
11000	18000	399	1309	2691	1224	4252	9221	96.1	157.7	220.9	–	1.86	HCB7218C.T.P4S
9000	15000	580	2021	4246	1707	6083	13095	230.4	362.8	483.7	–	1.86	HCB7218E.T.P4S

Direct-Lube design

HCB7018EDLR.T.P4S.UL

XC7018EDLR.T.P4S.UL

X-life ultra design

XC7018E.T.P4S.UL

XCB7018C.T.P4S.UL

See Bearing Code, page 178

SPINDLE BEARINGS

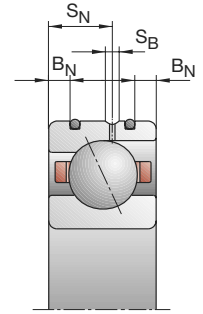
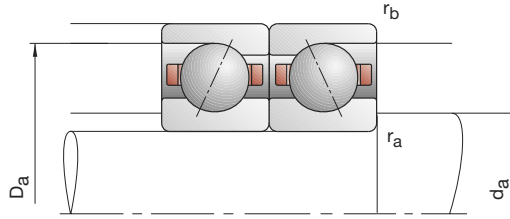
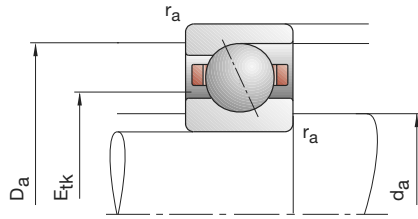

Bearing Code	Dimensions					Abutment Dimensions				DLR Dimensions			Load Ratings		
	d	D	B	r _{smin}	r _{1smin}	d _a h12	D _a H12	r _a max	r _b max	B _N	S _N	S _B	E _{tk}	C _{dyn}	C _{0stat}
FAG	mm													kN	
B71819C.TPA.P4	95	120	13	1.00	0.30	100	114.5	1.0	0.3				104.4	21.60	24.50
B71819E.TPA.P4	95	120	13	1.00	0.30	100	114.5	1.0	0.3				104.4	20.40	22.80
HCB71819C.TPA.P4	95	120	13	1.00	0.30	100	114.5	1.0	0.3				104.4	15.00	17.00
HCB71819E.TPA.P4	95	120	13	1.00	0.30	100	114.5	1.0	0.3				104.4	14.00	16.00
B71919C.T.P4S	95	130	18	1.10	1.10	102	124	0.6	0.6				109.2	46.50	51.00
B71919E.T.P4S	95	130	18	1.10	1.10	102	124	0.6	0.6				109.2	44.00	48.00
HCB71919C.T.P4S	95	130	18	1.10	1.10	102	124	0.6	0.6	4.0	10.4	2.2	109.2	32.00	35.50
HCB71919E.T.P4S	95	130	18	1.10	1.10	102	124	0.6	0.6	4.0	10.4	2.2	109.2	30.50	33.50
XCB71919C.T.P4S	95	130	18	1.10	1.10	102	124	0.6	0.6	4.0	10.4	2.2	109.2	71.00	35.50
XCB71919E.T.P4S	95	130	18	1.10	1.10	102	124	0.6	0.6	4.0	10.4	2.2	109.2	68.00	33.50
HS71919C.T.P4S	95	130	18	1.10	1.10	102	124	0.6	0.6				109.5	24.50	30.00
HS71919E.T.P4S	95	130	18	1.10	1.10	102	124	0.6	0.6				109.5	22.80	28.00
HC71919C.T.P4S	95	130	18	1.10	1.10	102	124	0.6	0.6	4.0	10.4	2.2	109.5	17.00	20.80
HC71919E.T.P4S	95	130	18	1.10	1.10	102	124	0.6	0.6	4.0	10.4	2.2	109.5	16.00	19.30
XC71919C.T.P4S	95	130	18	1.10	1.10	102	124	0.6	0.6	4.0	10.4	2.2	109.5	38.00	20.80
XC71919E.T.P4S	95	130	18	1.10	1.10	102	124	0.6	0.6	4.0	10.4	2.2	109.5	35.50	19.30
B7019C.T.P4S	95	145	24	1.50	1.50	105	136	1.5	0.6				113.6	78.00	76.50
B7019E.T.P4S	95	145	24	1.50	1.50	105	136	1.5	0.6				113.6	75.00	72.00
HCB7019C.T.P4S	95	145	24	1.50	1.50	105	136	1.5	0.6	5.5	14.5	2.2	113.6	54.00	53.00
HCB7019E.T.P4S	95	145	24	1.50	1.50	105	136	1.5	0.6	5.5	14.5	2.2	113.6	51.00	51.00
XCB7019C.T.P4S	95	145	24	1.50	1.50	105	136	1.5	0.6	5.5	14.5	2.2	113.6	120.00	53.00
XCB7019E.T.P4S	95	145	24	1.50	1.50	105	136	1.5	0.6	5.5	14.5	2.2	113.6	114.00	51.00
HS7019C.T.P4S	95	145	24	1.50	1.50	105	136	1.5	0.6				116.0	38.00	44.00
HS7019E.T.P4S	95	145	24	1.50	1.50	105	136	1.5	0.6				116.0	35.50	41.50
HC7019C.T.P4S	95	145	24	1.50	1.50	105	136	1.5	0.6	5.5	14.5	2.2	116.0	26.00	31.00
HC7019E.T.P4S	95	145	24	1.50	1.50	105	136	1.5	0.6	5.5	14.5	2.2	116.0	24.50	28.50
XC7019C.T.P4S	95	145	24	1.50	1.50	105	136	1.5	0.6	5.5	14.5	2.2	116.0	58.50	31.00
XC7019E.T.P4S	95	145	24	1.50	1.50	105	136	1.5	0.6	5.5	14.5	2.2	116.0	55.00	28.50
B7219C.T.P4S	95	170	32	2.10	2.10	110.5	154	2.0	2.0				125.8	127.00	114.00
B7219E.T.P4S	95	170	32	2.10	2.10	110.5	154	2.0	2.0				125.8	122.00	108.00
HCB7219C.T.P4S	95	170	32	2.10	2.10	110.5	154	2.0	2.0				125.8	88.00	80.00
HCB7219E.T.P4S	95	170	32	2.10	2.10	110.5	154	2.0	2.0				125.8	83.00	75.00
Designation examples:															
						Sealed design						Hybrid ceramic design			
						B7019C.2RSD.T.P4S.UL						HCB7019C.T.P4S.UL			
						HSS7019E.T.P4S.UL						HCB71819C.TPA.P4.UL			

SPINDLE BEARINGS

B718..C/E, B719, B70, B72 HS719..C/E, HS70

C: Contact Angle $\alpha = 15^\circ$ / E: Contact Angle $\alpha = 25^\circ$

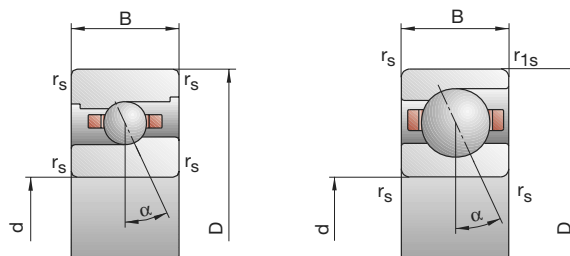

Attainable Speed Grease Oil minimal min ⁻¹	Preloading Force F _V			Unloading Force K _{aE}			Axial Rigidity S _a			Sealed Design	Weight kg	Bearing Code FAG	
	L	M	H	L	M	H	L	M	H				
10000	17000	92	343	737	278	1122	2586	60.5	107.9	158.4	–	0.29	B71819C.TPA.P4
9000	15000	111	504	1137	319	1497	3485	133.7	234.0	324.9	–	0.29	B71819E.TPA.P4
13000	20000	46	199	444	137	629	1484	52.1	94.0	135.7	–	0.29	HCB71819C.TPA.P4
11000	18000	77	267	655	222	786	1974	133.0	208.0	292.4	–	0.29	HCB71819E.TPA.P4
9500	16000	245	827	1724	755	2752	6135	84.9	145.9	211.1	•	0.58	B71919C.T.P4S
8500	14000	343	1269	2713	1002	3820	8439	196.4	320.5	436.5	•	0.58	B71919E.T.P4S
12000	19000	121	443	947	365	1415	3185	72.3	122.5	173.0	•	0.49	HCB71919C.T.P4S
10000	17000	150	663	1487	439	1982	4537	166.6	283.4	384.9	•	0.49	HCB71919E.T.P4S
16000	26000	121	443	947	365	1415	3185	72.3	122.5	173.0	•	0.49	XCB71919C.T.P4S
14000	22000	150	663	1487	439	1982	4537	166.6	283.4	384.9	•	0.49	XCB71919E.T.P4S
12000	19000	85	255	509	252	789	1651	60.8	94.8	129.4	•	0.66	HS71919C.T.P4S
10000	17000	138	414	828	395	1205	2455	152.8	226.9	295.0	•	0.66	HS71919E.T.P4S
14000	22000	59	177	354	174	541	1122	59.7	91.4	122.5	•	0.61	HC71919C.T.P4S
12000	19000	96	288	575	277	842	1704	153.1	225.5	290.4	•	0.61	HC71919E.T.P4S
18000	30000	59	177	354	174	541	1122	59.7	91.4	122.5	•	0.61	XC71919C.T.P4S
16000	26000	96	288	575	277	842	1704	153.1	225.5	290.4	•	0.61	XC71919E.T.P4S
9000	15000	447	1452	2980	1388	4880	10731	99.4	169.3	244.3	•	1.20	B7019C.T.P4S
8000	13000	675	2308	4813	1981	7005	15060	234.4	373.7	505.1	•	1.20	B7019E.T.P4S
11000	18000	238	811	1692	724	2617	5757	86.7	144.1	202.4	•	1.01	HCB7019C.T.P4S
9500	16000	325	1231	2641	954	3694	8096	204.9	331.4	444.1	•	1.01	HCB7019E.T.P4S
15000	24000	238	811	1692	724	2617	5757	86.7	144.1	202.4	•	1.01	XCB7019C.T.P4S
13000	20000	325	1231	2641	954	3694	8096	204.9	331.4	444.1	•	1.01	XCB7019E.T.P4S
11000	18000	130	389	777	385	1210	2529	67.4	105.5	144.1	•	1.34	HS7019C.T.P4S
9500	16000	211	633	1265	604	1847	3756	169.3	251.8	327.5	•	1.34	HS7019E.T.P4S
13000	20000	89	268	536	263	822	1702	65.9	101.3	135.7	•	1.24	HC7019C.T.P4S
11000	18000	146	437	874	422	1277	2591	169.3	249.1	321.4	•	1.25	HC7019E.T.P4S
17000	28000	89	268	536	263	822	1702	65.9	101.3	135.7	•	1.24	XC7019C.T.P4S
14000	22000	146	437	874	422	1277	2591	169.3	249.1	321.4	•	1.25	XC7019E.T.P4S
8000	13000	768	2426	4937	2398	8203	17878	115.7	195.6	281.8	–	2.78	B7219C.T.P4S
7000	11000	1193	3906	8042	3509	11890	25320	274.2	431.5	582.0	–	2.78	B7219E.T.P4S
10000	17000	411	1353	2784	1258	4384	9513	101.0	165.9	232.1	–	2.36	HCB7219C.T.P4S
8500	14000	598	2092	4400	1759	6291	13552	242.8	382.6	510.0	–	2.36	HCB7219E.T.P4S

Direct-Lube design
HCB7019EDLR.T.P4S.UL
XC7019EDLR.T.P4S.UL

X-life ultra design
XC7019E.T.P4S.UL
XCB7019C.T.P4S.UL

See Bearing Code, page 178

SPINDLE BEARINGS

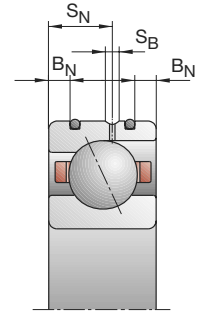
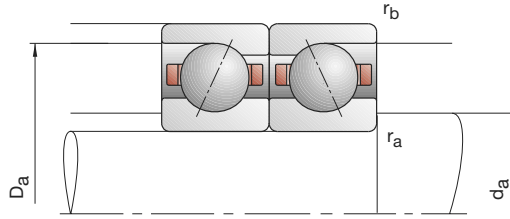
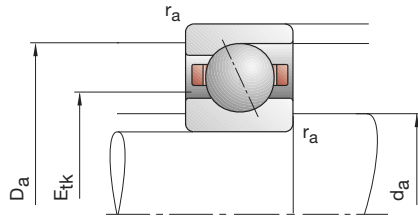

Bearing Code	Dimensions					Abutment Dimensions				DLR Dimensions			Load Ratings		
	d	D	B	r _{smin}	r _{1smin}	d _a h12	D _a H12	r _a max	r _b max	B _N	S _N	S _B	E _{tk}	C _{dyn}	C _{0stat}
FAG	mm													kN	
B71820C.TPA.P4	100	125	13	1.00	0.30	105	119.5	1.0	0.3				109.4	21.60	25.00
B71820E.TPA.P4	100	125	13	1.00	0.30	105	119.5	1.0	0.3				109.4	20.40	23.60
HCB71820C.TPA.P4	100	125	13	1.00	0.30	105	119.5	1.0	0.3				109.4	15.00	17.60
HCB71820E.TPA.P4	100	125	13	1.00	0.30	105	119.5	1.0	0.3				109.4	14.00	16.30
B71920C.T.P4S	100	140	20	1.10	1.10	107	133	0.6	0.6				117.2	58.50	64.00
B71920E.T.P4S	100	140	20	1.10	1.10	107	133	0.6	0.6				117.2	55.00	60.00
HCB71920C.T.P4S	100	140	20	1.10	1.10	107	133	0.6	0.6	4.0	12.0	2.2	117.2	40.50	44.00
HCB71920E.T.P4S	100	140	20	1.10	1.10	107	133	0.6	0.6	4.0	12.0	2.2	117.2	38.00	42.50
XCB71920C.T.P4S	100	140	20	1.10	1.10	107	133	0.6	0.6	4.0	12.0	2.2	117.2	90.00	44.00
XCB71920E.T.P4S	100	140	20	1.10	1.10	107	133	0.6	0.6	4.0	12.0	2.2	117.2	85.00	42.50
HS71920C.T.P4S	100	140	20	1.10	1.10	107	133	0.6	0.6				116.7	29.00	36.00
HS71920E.T.P4S	100	140	20	1.10	1.10	107	133	0.6	0.6				116.7	27.50	33.50
HC71920C.T.P4S	100	140	20	1.10	1.10	107	133	0.6	0.6	4.0	12.0	2.2	116.7	20.40	25.00
HC71920E.T.P4S	100	140	20	1.10	1.10	107	133	0.6	0.6	4.0	12.0	2.2	116.7	19.00	23.60
XC71920C.T.P4S	100	140	20	1.10	1.10	107	133	0.6	0.6	4.0	12.0	2.2	116.7	45.50	25.00
XC71920E.T.P4S	100	140	20	1.10	1.10	107	133	0.6	0.6	4.0	12.0	2.2	116.7	42.50	23.60
B7020C.T.P4S	100	150	24	1.50	1.50	110	141	1.5	0.6				118.6	81.50	81.50
B7020E.T.P4S	100	150	24	1.50	1.50	110	141	1.5	0.6				118.6	76.50	76.50
HCB7020C.T.P4S	100	150	24	1.50	1.50	110	141	1.5	0.6	5.5	14.5	2.2	118.6	56.00	56.00
HCB7020E.T.P4S	100	150	24	1.50	1.50	110	141	1.5	0.6	5.5	14.5	2.2	118.6	53.00	53.00
XCB7020C.T.P4S	100	150	24	1.50	1.50	110	141	1.5	0.6	5.5	14.5	2.2	118.6	125.00	56.00
XCB7020E.T.P4S	100	150	24	1.50	1.50	110	141	1.5	0.6	5.5	14.5	2.2	118.6	118.00	53.00
HS7020C.T.P4S	100	150	24	1.50	1.50	110	141	1.5	0.6				121.0	38.00	45.50
HS7020E.T.P4S	100	150	24	1.50	1.50	110	141	1.5	0.6				121.0	36.00	42.50
HC7020C.T.P4S	100	150	24	1.50	1.50	110	141	1.5	0.6	5.5	14.5	2.2	121.0	26.50	31.50
HC7020E.T.P4S	100	150	24	1.50	1.50	110	141	1.5	0.6	5.5	14.5	2.2	121.0	25.00	30.00
XC7020C.T.P4S	100	150	24	1.50	1.50	110	141	1.5	0.6	5.5	14.5	2.2	121.0	58.50	31.50
XC7020E.T.P4S	100	150	24	1.50	1.50	110	141	1.5	0.6	5.5	14.5	2.2	121.0	56.00	30.00
B7220C.T.P4S	100	180	34	2.10	2.10	114.5	165.5	2.1	2.1				132.4	132.00	122.00
B7220E.T.P4S	100	180	34	2.10	2.10	114.5	165.5	2.1	2.1				132.4	125.00	116.00
HCB7220C.T.P4S	100	180	34	2.10	2.10	114.5	165.5	2.1	2.1				132.4	91.50	85.00
HCB7220E.T.P4S	100	180	34	2.10	2.10	114.5	165.5	2.1	2.1				132.4	86.50	81.50

Designation examples:

Sealed design

B7020C.2RSD.T.P4S.UL

HSS7020E.T.P4S.UL

Hybrid ceramic design

HCB7020C.T.P4S.UL

HCB71820C.TPA.P4.UL

SPINDLE BEARINGS

B718..C/E, B719, B70, B72 HS719..C/E, HS70

C: Contact Angle $\alpha = 15^\circ$ / E: Contact Angle $\alpha = 25^\circ$

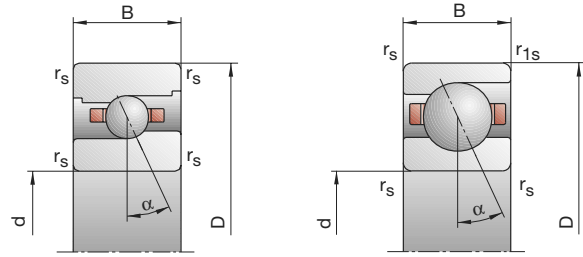

100

Attainable Speed	Grease	Oil minimal	Preloading Force F_V			Unloading Force K_{aE}			Axial Rigidity S_a			Sealed Design	Weight	Bearing Code
			L	M	H	L	M	H	L	M	H			
min ⁻¹			N			N/μm			kg				FAG	
9500	16000	91	341	735	274	1112	2570	61.2	109.4	160.6	–	0.30	B71820C.TPA.P4	
8500	14000	109	500	1132	313	1483	3464	135.5	237.9	330.4	–	0.30	B71820E.TPA.P4	
12000	19000	46	203	454	136	641	1517	52.8	96.5	139.5	–	0.30	HCB71820C.TPA.P4	
10000	17000	79	272	669	228	801	2016	137.2	213.8	300.7	–	0.30	HCB71820E.TPA.P4	
9000	15000	318	1059	2194	980	3524	7827	94.6	161.7	233.7	•	0.79	B71920C.T.P4S	
8000	13000	453	1626	3437	1323	4902	10706	219.8	355.1	481.6	•	0.79	B71920E.T.P4S	
11000	18000	161	576	1220	488	1841	4106	81.4	136.6	192.3	•	0.66	HCB71920C.T.P4S	
9500	16000	204	852	1881	596	2544	5745	188.0	313.9	424.3	•	0.66	HCB71920E.T.P4S	
15000	24000	161	576	1220	488	1841	4106	81.4	136.6	192.3	•	0.66	XCB71920C.T.P4S	
12000	19000	204	852	1881	596	2544	5745	188.0	313.9	424.3	•	0.66	XCB71920E.T.P4S	
11000	18000	102	306	611	301	947	1978	65.5	102.4	139.7	•	0.90	HS71920C.T.P4S	
9500	16000	166	497	994	476	1447	2950	165.5	245.4	319.2	•	0.90	HS71920E.T.P4S	
13000	20000	70	209	418	207	639	1324	64.4	98.3	131.5	•	0.84	HC71920C.T.P4S	
11000	18000	115	345	690	332	1009	2046	165.4	243.6	314.1	•	0.84	HC71920E.T.P4S	
17000	28000	70	209	418	207	639	1324	64.4	98.3	131.5	•	0.84	XC71920C.T.P4S	
14000	22000	115	345	690	332	1009	2046	165.4	243.6	314.1	•	0.84	XC71920E.T.P4S	
8500	14000	467	1516	3112	1450	5092	11199	104.1	177.2	255.8	•	1.26	B7020C.T.P4S	
7500	12000	685	2347	4902	2009	7114	15314	243.1	387.4	523.6	•	1.26	B7020E.T.P4S	
11000	18000	238	818	1707	723	2632	5787	89.4	148.6	208.5	•	1.05	HCB7020C.T.P4S	
9000	15000	334	1272	2731	980	3815	8366	213.5	345.9	463.5	•	1.05	HCB7020E.T.P4S	
14000	22000	238	818	1707	723	2632	5787	89.4	148.6	208.5	•	1.05	XCB7020C.T.P4S	
12000	19000	334	1272	2731	980	3815	8366	213.5	345.9	463.5	•	1.05	XCB7020E.T.P4S	
11000	18000	134	402	804	397	1250	2618	69.5	108.9	149.0	•	1.40	HS7020C.T.P4S	
9000	15000	215	644	1288	615	1879	3822	173.9	258.6	336.2	•	1.40	HS7020E.T.P4S	
12000	19000	91	273	547	269	837	1736	67.8	104.0	139.4	•	1.29	HC7020C.T.P4S	
11000	18000	148	444	888	428	1297	2631	173.8	255.7	329.8	•	1.29	HC7020E.T.P4S	
16000	26000	91	273	547	269	837	1736	67.8	104.0	139.4	•	1.29	XC7020C.T.P4S	
14000	22000	148	444	888	428	1297	2631	173.8	255.7	329.8	•	1.29	XC7020E.T.P4S	
7500	12000	796	2519	5128	2482	8499	18521	121.7	205.5	295.8	–	3.32	B7220C.T.P4S	
6700	10000	1217	3994	8229	3576	12137	25856	287.0	451.4	608.5	–	3.32	B7220E.T.P4S	
9500	16000	428	1408	2898	1309	4556	9884	106.4	174.6	244.2	–	2.87	HCB7220C.T.P4S	
8000	13000	623	2181	5427	1832	6554	16724	256.2	403.6	548.1	–	2.87	HCB7220E.T.P4S	

Direct-Lube design

HCB7020EDLR.T.P4S.UL

XC7020EDLR.T.P4S.UL

X-life ultra design

XC7020E.T.P4S.UL

XCB7020C.T.P4S.UL

See Bearing Code, page 178

SPINDLE BEARINGS

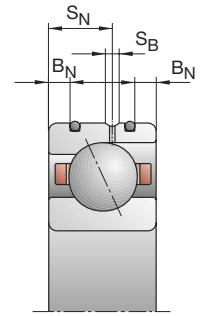
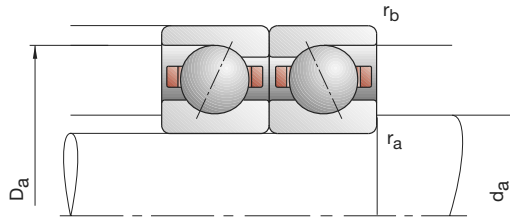
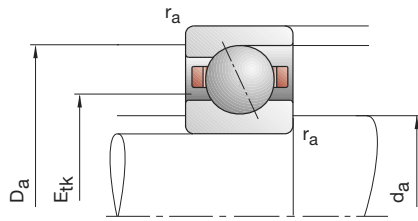

Bearing Code	Dimensions					Abutment Dimensions				DLR Dimensions			Load Ratings		
	d	D	B	r _{smin}	r _{1smin}	d _a h12	D _a H12	r _a max	r _b max	B _N	S _N	S _B	E _{tk}	C _{dyn}	C _{0stat}
FAG	mm													kN	
B71821C.TPA.P4	105	130	13	1.00	0.30	110	124.5	1.0	0.3				114.4	22.80	27.50
B71821E.TPA.P4	105	130	13	1.00	0.30	110	124.5	1.0	0.3				114.4	21.60	25.50
HCB71821C.TPA.P4	105	130	13	1.00	0.30	110	124.5	1.0	0.3				114.4	15.60	19.00
HCB71821E.TPA.P4	105	130	13	1.00	0.30	110	124.5	1.0	0.3				114.4	15.00	18.00
B71921C.T.P4S	105	145	20	1.10	1.10	112	138	0.6	0.6				121.2	58.50	64.00
B71921E.T.P4S	105	145	20	1.10	1.10	112	138	0.6	0.6				121.2	55.00	60.00
HCB71921C.T.P4S	105	145	20	1.10	1.10	112	138	0.6	0.6	4.0	12.0	2.2	121.2	40.00	45.00
HCB71921E.T.P4S	105	145	20	1.10	1.10	112	138	0.6	0.6	4.0	12.0	2.2	121.2	38.00	42.50
XCB71921C.T.P4S	105	145	20	1.10	1.10	112	138	0.6	0.6	4.0	12.0	2.2	121.2	90.00	45.00
XCB71921E.T.P4S	105	145	20	1.10	1.10	112	138	0.6	0.6	4.0	12.0	2.2	121.2	85.00	42.50
HS71921C.T.P4S	105	145	20	1.10	1.10	112	138	0.6	0.6				121.7	30.00	38.00
HS71921E.T.P4S	105	145	20	1.10	1.10	112	138	0.6	0.6				121.7	28.00	35.50
HC71921C.T.P4S	105	145	20	1.10	1.10	112	138	0.6	0.6	4.0	12.0	2.2	121.7	20.80	26.50
HC71921E.T.P4S	105	145	20	1.10	1.10	112	138	0.6	0.6	4.0	12.0	2.2	121.7	19.60	24.50
XC71921C.T.P4S	105	145	20	1.10	1.10	112	138	0.6	0.6	4.0	12.0	2.2	121.7	46.50	26.50
XC71921E.T.P4S	105	145	20	1.10	1.10	112	138	0.6	0.6	4.0	12.0	2.2	121.7	44.00	24.50
B7021C.T.P4S	105	160	26	2.00	2.00	116	150	2.0	1.0				125.8	106.00	102.00
B7021E.T.P4S	105	160	26	2.00	2.00	116	150	2.0	1.0				125.8	102.00	98.00
HCB7021C.T.P4S	105	160	26	2.00	2.00	116	150	2.0	1.0	6.0	15.2	2.2	125.8	73.50	72.00
HCB7021E.T.P4S	105	160	26	2.00	2.00	116	150	2.0	1.0	6.0	15.2	2.2	125.8	69.50	68.00
XCB7021C.T.P4S	105	160	26	2.00	2.00	116	150	2.0	1.0	6.0	15.2	2.2	125.8	163.00	72.00
XCB7021E.T.P4S	105	160	26	2.00	2.00	116	150	2.0	1.0	6.0	15.2	2.2	125.8	156.00	68.00
HS7021C.T.P4S	105	160	26	2.00	2.00	116	150	2.0	1.0				127.9	49.00	58.50
HS7021E.T.P4S	105	160	26	2.00	2.00	116	150	2.0	1.0				127.9	46.50	54.00
HC7021C.T.P4S	105	160	26	2.00	2.00	116	150	2.0	1.0	6.0	15.2	2.2	127.9	34.00	40.50
HC7021E.T.P4S	105	160	26	2.00	2.00	116	150	2.0	1.0	6.0	15.2	2.2	127.9	32.00	38.00
XC7021C.T.P4S	105	160	26	2.00	2.00	116	150	2.0	1.0	6.0	15.2	2.2	127.9	76.50	40.50
XC7021E.T.P4S	105	160	26	2.00	2.00	116	150	2.0	1.0	6.0	15.2	2.2	127.9	71.00	38.00
B7221C.T.P4S	105	190	36	2.10	2.10	120.5	174.5	2.1	2.1				139.9	163.00	146.00
B7221E.T.P4S	105	190	36	2.10	2.10	120.5	174.5	2.1	2.1				139.9	156.00	140.00
HCB7221C.T.P4S	105	190	36	2.10	2.10	120.5	174.5	2.1	2.1				139.9	112.00	102.00
HCB7221E.T.P4S	105	190	36	2.10	2.10	120.5	174.5	2.1	2.1				139.9	106.00	98.00

Designation examples:

Sealed design

B7021C.2RSD.T.P4S.UL

HSS7021E.T.P4S.UL

Hybrid ceramic design

HCB7021C.T.P4S.UL

HCB71821C.TPA.P4.UL

SPINDLE BEARINGS

B718..C/E, B719, B70, B72 HS719..C/E, HS70

C: Contact Angle $\alpha = 15^\circ$ / E: Contact Angle $\alpha = 25^\circ$

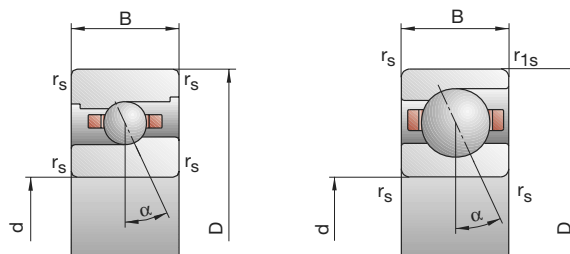

105

Attainable Speed Grease	Oil minimal	Preloading Force F_V			Unloading Force K_{aE}			Axial Rigidity S_a			Sealed Design	Weight kg	Bearing Code FAG
		L	M	H	L	M	H	L	M	H			
min ⁻¹		N						N/ μ m					
9000	15000	95	358	774	286	1164	2696	65.9	117.3	172.2	–	0.3	B71821C.TPA.P4
8000	13000	112	525	1193	321	1555	3644	144.8	256.0	355.8	–	0.3	B71821E.TPA.P4
12000	19000	47	209	470	139	658	1563	56.4	102.9	148.6	–	0.3	HCB71821C.TPA.P4
10000	17000	80	278	686	231	817	2062	146.2	227.9	320.5	–	0.3	HCB71821E.TPA.P4
8500	14000	318	1059	2194	980	3524	7826	94.6	161.7	233.7	•	0.8	B71921C.T.P4S
7500	12000	453	1626	3437	1323	4902	10705	219.8	355.1	481.6	•	0.8	B71921E.T.P4S
11000	18000	161	576	1220	487	1840	4105	81.2	136.6	192.3	•	0.7	HCB71921C.T.P4S
9000	15000	204	852	1881	596	2543	5745	188.0	313.8	424.3	•	0.7	HCB71921E.T.P4S
14000	22000	161	576	1220	487	1840	4105	81.2	136.6	192.3	•	0.7	XCB71921C.T.P4S
12000	19000	204	852	1881	596	2543	5745	188.0	313.8	424.3	•	0.7	XCB71921E.T.P4S
11000	18000	104	311	622	307	961	2008	68.3	106.4	144.9	•	0.9	HS71921C.T.P4S
9000	15000	169	506	1012	484	1472	2999	172.2	255.3	331.8	•	0.9	HS71921E.T.P4S
12000	19000	71	214	429	209	653	1357	66.7	102.3	137.0	•	0.9	HC71921C.T.P4S
11000	18000	117	352	704	337	1029	2086	171.9	253.8	327.1	•	0.9	HC71921E.T.P4S
16000	26000	71	214	429	209	653	1357	66.7	102.3	137.0	•	0.9	XC71921C.T.P4S
14000	22000	117	352	704	337	1029	2086	171.9	253.8	327.1	•	0.9	XC71921E.T.P4S
8000	13000	625	1999	4083	1942	6714	14681	114.3	193.4	278.6	•	1.6	B7021C.T.P4S
7000	11000	960	3206	6639	2816	9723	20806	270.9	428.4	578.2	•	1.6	B7021E.T.P4S
10000	17000	337	1125	2328	1028	3629	7914	100.3	165.2	231.3	•	1.3	HCB7021C.T.P4S
8500	14000	470	1703	3618	1383	5119	11103	238.4	379.6	506.8	•	1.3	HCB7021E.T.P4S
13000	20000	337	1125	2328	1028	3629	7914	100.3	165.2	231.3	•	1.3	XCB7021C.T.P4S
11000	18000	470	1703	3618	1383	5119	11103	238.4	379.6	506.8	•	1.3	XCB7021E.T.P4S
10000	17000	170	509	1018	504	1580	3317	75.9	118.7	162.4	•	1.8	HS7021C.T.P4S
8500	14000	276	828	1656	790	2412	4919	190.6	283.4	368.9	•	1.8	HS7021E.T.P4S
12000	19000	118	355	710	350	1088	2259	74.8	114.6	153.8	•	1.6	HC7021C.T.P4S
10000	17000	192	575	1150	555	1682	3412	191.0	281.3	362.9	•	1.6	HC7021E.T.P4S
15000	24000	118	355	710	350	1088	2259	74.8	114.6	153.8	•	1.6	XC7021C.T.P4S
13000	21000	192	575	1150	555	1682	3412	191.0	281.3	362.9	•	1.6	XC7021E.T.P4S
7000	11000	997	3140	6377	3116	10597	23098	132.0	222.4	320.4	–	4.0	B7221C.T.P4S
6300	9500	1558	5040	10337	4587	15335	32479	313.5	490.7	660.3	–	4.0	B7221E.T.P4S
9000	15000	535	1734	3559	1635	5604	12126	115.2	187.9	262.4	–	3.3	HCB7221C.T.P4S
7500	12000	805	2756	5751	2371	8297	17714	280.6	438.8	583.1	–	3.3	HCB7221E.T.P4S

Direct-Lube design

HCB7021EDLR.T.P4S.UL

XC7021EDLR.T.P4S.UL

X-life ultra design

XC7021E.T.P4S.UL

XCB7021C.T.P4S.UL

See Bearing Code, page 178

SPINDLE BEARINGS

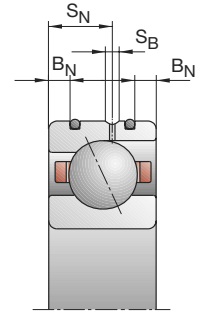
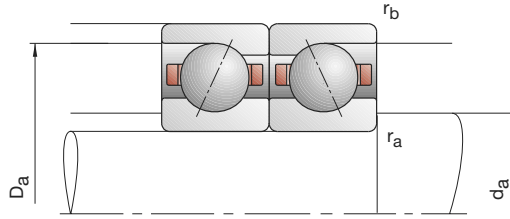
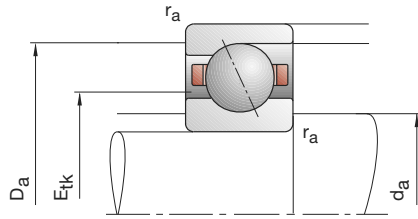

Bearing Code	Dimensions					Abutment Dimensions				DLR Dimensions			Load Ratings		
	d	D	B	r _{smin}	r _{1smin}	d _a h12	D _a H12	r _a max	r _b max	B _N	S _N	S _B	E _{tk}	C _{dyn}	C _{0stat}
FAG	mm													kN	
B71822C.TPA.P4	110	140	16	1.00	0.30	116	133.5	1.0	0.3				121.2	31.50	36.50
B71822E.TPA.P4	110	140	16	1.00	0.30	116	133.5	1.0	0.3				121.2	29.00	34.00
HCB71822C.TPA.P4	110	140	16	1.00	0.30	116	133.5	1.0	0.3				121.2	21.60	25.50
HCB71822E.TPA.P4	110	140	16	1.00	0.30	116	133.5	1.0	0.3				121.2	20.40	24.00
B71922C.T.P4S	110	150	20	1.10	1.10	117	143	0.6	0.6				126.2	58.50	67.00
B71922E.T.P4S	110	150	20	1.10	1.10	117	143	0.6	0.6				126.2	56.00	63.00
HCB71922C.T.P4S	110	150	20	1.10	1.10	117	143	0.6	0.6	4.0	12.0	2.2	126.2	40.50	46.50
HCB71922E.T.P4S	110	150	20	1.10	1.10	117	143	0.6	0.6	4.0	12.0	2.2	126.2	39.00	44.00
XCB71922C.T.P4S	110	150	20	1.10	1.10	117	143	0.6	0.6	4.0	12.0	2.2	126.2	90.00	46.50
XCB71922E.T.P4S	110	150	20	1.10	1.10	117	143	0.6	0.6	4.0	12.0	2.2	126.2	86.50	44.00
HS71922C.T.P4S	110	150	20	1.10	1.10	117	143	0.6	0.6				126.4	34.50	44.00
HS71922E.T.P4S	110	150	20	1.10	1.10	117	143	0.6	0.6				126.4	32.50	40.50
HC71922C.T.P4S	110	150	20	1.10	1.10	117	143	0.6	0.6	4.0	12.0	2.2	126.4	24.00	30.50
HC71922E.T.P4S	110	150	20	1.10	1.10	117	143	0.6	0.6	4.0	12.0	2.2	126.4	22.80	28.50
XC71922C.T.P4S	110	150	20	1.10	1.10	117	143	0.6	0.6	4.0	12.0	2.2	126.4	54.00	30.50
XC71922E.T.P4S	110	150	20	1.10	1.10	117	143	0.6	0.6	4.0	12.0	2.2	126.4	51.00	28.50
B7022C.T.P4S	110	170	28	2.00	2.00	121	159	2.0	1.0				133.3	110.00	110.00
B7022E.T.P4S	110	170	28	2.00	2.00	121	159	2.0	1.0				133.3	104.00	104.00
HCB7022C.T.P4S	110	170	28	2.00	2.00	121	159	2.0	1.0	6.0	16.2	2.2	133.3	75.00	76.50
HCB7022E.T.P4S	110	170	28	2.00	2.00	121	159	2.0	1.0	6.0	16.2	2.2	133.3	72.00	72.00
XCB7022C.T.P4S	110	170	28	2.00	2.00	121	159	2.0	1.0	6.0	16.2	2.2	133.3	166.00	76.50
XCB7022E.T.P4S	110	170	28	2.00	2.00	121	159	2.0	1.0	6.0	16.2	2.2	133.3	160.00	72.00
HS7022C.T.P4S	110	170	28	2.00	2.00	121	159	2.0	1.0				135.4	50.00	60.00
HS7022E.T.P4S	110	170	28	2.00	2.00	121	159	2.0	1.0				135.4	46.50	56.00
HC7022C.T.P4S	110	170	28	2.00	2.00	121	159	2.0	1.0	6.0	16.2	2.2	135.4	34.50	41.50
HC7022E.T.P4S	110	170	28	2.00	2.00	121	159	2.0	1.0	6.0	16.2	2.2	135.4	32.50	39.00
XC7022C.T.P4S	110	170	28	2.00	2.00	121	159	2.0	1.0	6.0	16.2	2.2	135.4	76.50	41.50
XC7022E.T.P4S	110	170	28	2.00	2.00	121	159	2.0	1.0	6.0	16.2	2.2	135.4	72.00	39.00
B7222C.T.P4S	110	200	38	2.10	2.10	126.5	183.5	2.1	2.1				147.4	163.00	150.00
B7222E.T.P4S	110	200	38	2.10	2.10	126.5	183.5	2.1	2.1				147.4	153.00	143.00
HCB7222C.T.P4S	110	200	38	2.10	2.10	126.5	183.5	2.1	2.1				147.4	112.00	104.00
HCB7222E.T.P4S	110	200	38	2.10	2.10	126.5	183.5	2.1	2.1				147.4	106.00	98.00

Designation examples:

Sealed design

B7022C.2RSD.T.P4S.UL

HSS7022E.T.P4S.UL

Hybrid ceramic design

HCB7022C.T.P4S.UL

HCB71822C.TPA.P4.UL

SPINDLE BEARINGS

B718..C/E, B719, B70, B72 HS719..C/E, HS70

C: Contact Angle $\alpha = 15^\circ$ / E: Contact Angle $\alpha = 25^\circ$

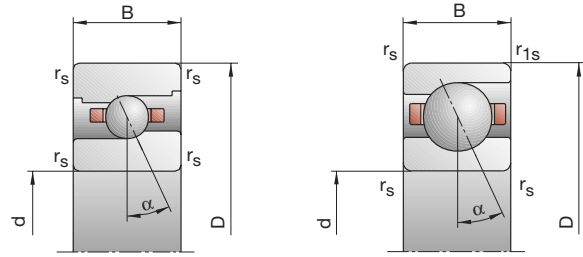

Attainable Speed	Grease	Oil minimal	Preloading Force F_V			Unloading Force K_{aE}			Axial Rigidity S_a			Sealed Design	Weight	Bearing Code
			L	M	H	L	M	H	L	M	H			
min ⁻¹			N			N/μm			kg				FAG	
8500	14000	146	521	1105	445	1721	3917	77.1	135.8	198.7	–	0.5	B71822C.TPA.P4	
7500	12000	181	757	1673	522	2259	5156	170.6	291.1	401.7	–	0.5	B71822E.TPA.P4	
11000	18000	79	315	690	237	1006	2334	68.0	120.1	172.8	–	0.5	HCB71822C.TPA.P4	
9000	15000	83	445	1042	240	1320	3173	147.3	268.8	372.7	–	0.5	HCB71822E.TPA.P4	
8000	13000	316	1056	2191	972	3501	7781	96.5	164.8	237.9	•	0.8	B71922C.T.P4S	
7500	12000	458	1651	3495	1337	4973	10873	226.3	365.8	496.2	•	0.8	B71922E.T.P4S	
10000	17000	163	583	1236	493	1860	4150	83.7	140.4	197.5	•	0.7	HCB71922C.T.P4S	
9000	15000	205	861	1905	599	2569	5813	193.3	323.0	436.8	•	0.7	HCB71922E.T.P4S	
13000	20000	163	583	1236	493	1860	4150	83.7	140.4	197.5	•	0.7	XCB71922C.T.P4S	
11000	18000	205	861	1905	599	2569	5813	193.3	323.0	436.8	•	0.7	XCB71922E.T.P4S	
10000	17000	121	362	724	357	1120	2342	71.5	111.7	152.3	•	1.0	HS71922C.T.P4S	
8500	14000	196	587	1173	560	1709	3480	180.2	267.6	347.7	•	1.0	HS71922E.T.P4S	
12000	19000	83	249	498	245	761	1573	70.2	107.4	143.6	•	0.9	HC71922C.T.P4S	
10000	17000	135	405	810	390	1185	2395	180.2	265.2	341.3	•	0.9	HC71922E.T.P4S	
15000	24000	83	249	498	245	761	1573	70.2	107.4	143.6	•	0.9	XC71922C.T.P4S	
13000	20000	135	405	810	390	1185	2395	180.2	265.2	341.3	•	0.9	XC71922E.T.P4S	
7500	12000	648	2072	4235	2011	6949	15201	119.6	202.1	290.9	•	2.0	B7022C.T.P4S	
6700	10000	975	3262	6760	2857	9878	21147	281.3	444.8	600.0	•	2.0	B7022E.T.P4S	
9500	16000	340	1140	2363	1035	3667	8007	103.8	170.9	239.2	•	1.7	HCB7022C.T.P4S	
8000	13000	479	1742	3707	1408	5232	11364	248.0	395.3	527.8	•	1.7	HCB7022E.T.P4S	
12000	19000	340	1140	2363	1035	3667	8007	103.8	170.9	239.2	•	1.7	XCB7022C.T.P4S	
10000	17000	479	1742	3707	1408	5232	11364	248.0	395.3	527.8	•	1.7	XCB7022E.T.P4S	
9500	16000	174	523	1045	516	1623	3403	78.2	122.3	167.3	•	2.2	HS7022C.T.P4S	
8000	13000	280	840	1679	802	2446	4984	195.8	290.9	378.4	•	2.2	HS7022E.T.P4S	
11000	18000	118	355	710	349	1086	2254	76.2	116.8	156.6	•	2.1	HC7022C.T.P4S	
9000	15000	192	575	1150	555	1681	3409	195.2	287.3	370.4	•	2.1	HC7022E.T.P4S	
14000	22000	118	355	710	349	1086	2254	76.2	116.8	156.6	•	2.1	XC7022C.T.P4S	
12000	19000	192	575	1150	555	1681	3409	195.2	287.3	370.4	•	2.1	XC7022E.T.P4S	
6700	10000	997	3139	6376	3115	10591	23087	132.0	222.4	320.3	–	4.7	B7222C.T.P4S	
6000	9000	1525	4939	10131	4487	15015	31793	311.0	486.8	654.6	–	4.7	B7222E.T.P4S	
8500	14000	535	1734	3558	1635	5602	12118	115.2	187.8	262.3	–	4.0	HCB7222C.T.P4S	
7000	11000	789	2705	5648	2322	8137	17383	278.5	435.7	578.9	–	4.0	HCB7222E.T.P4S	

Direct-Lube design

HCB7022EDLR.T.P4S.UL

XC7022EDLR.T.P4S.UL

X-life ultra design

XC7022E.T.P4S.UL

XCB7022C.T.P4S.UL

See Bearing Code, page 178

SPINDLE BEARINGS

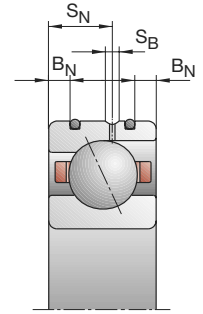
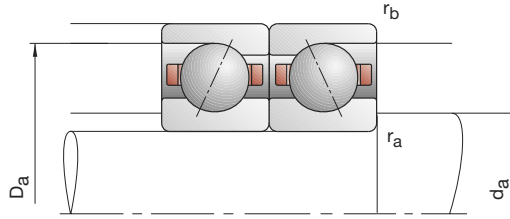
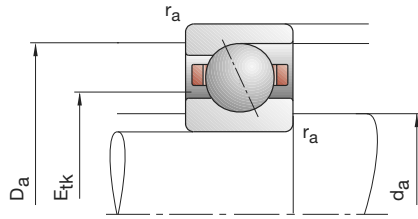

Bearing Code	Dimensions					Abutment Dimensions				DLR Dimensions			Load Ratings			
	d	D	B	r _{smin}	r _{1smin}	d _a h12	D _a H12	r _a max	r _b max	B _N	S _N	S _B	E _{tk}	C _{dyn}	C _{0stat}	
FAG	mm														kN	
B71824C.TPA.P4	120	150	16	1.00	0.30	126	143.5	1.0	0.3				131.2	32.00	39.00	
B71824E.TPA.P4	120	150	16	1.00	0.30	126	143.5	1.0	0.3				131.2	30.00	36.00	
HCB71824C.TPA.P4	120	150	16	1.00	0.30	126	143.5	1.0	0.3				131.2	22.00	27.00	
HCB71824E.TPA.P4	120	150	16	1.00	0.30	126	143.5	1.0	0.3				131.2	20.80	25.00	
B71924C.T.P4S	120	165	22	1.10	1.10	128	157	0.6	0.6				138.2	73.50	85.00	
B71924E.T.P4S	120	165	22	1.10	1.10	128	157	0.6	0.6				138.2	69.50	80.00	
HCB71924C.T.P4S	120	165	22	1.10	1.10	128	157	0.6	0.6				138.2	51.00	58.50	
HCB71924E.T.P4S	120	165	22	1.10	1.10	128	157	0.6	0.6				138.2	48.00	55.00	
XCB71924C.T.P4S	120	165	22	1.10	1.10	128	157	0.6	0.6				138.2	114.00	58.50	
XCB71924E.T.P4S	120	165	22	1.10	1.10	128	157	0.6	0.6				138.2	108.00	55.00	
HS71924C.T.P4S	120	165	22	1.10	1.10	128	157	0.6	0.6				138.9	36.50	48.00	
HS71924E.T.P4S	120	165	22	1.10	1.10	128	157	0.6	0.6				138.9	34.00	45.00	
HC71924C.T.P4S	120	165	22	1.10	1.10	128	157	0.6	0.6				138.9	25.00	33.50	
HC71924E.T.P4S	120	165	22	1.10	1.10	128	157	0.6	0.6				138.9	23.60	31.00	
XC71924C.T.P4S	120	165	22	1.10	1.10	128	157	0.6	0.6				138.9	56.00	33.50	
XC71924E.T.P4S	120	165	22	1.10	1.10	128	157	0.6	0.6				138.9	53.00	31.00	
B7024C.T.P4S	120	180	28	2.00	2.00	131	169	2.0	1.0				143.3	112.00	116.00	
B7024E.T.P4S	120	180	28	2.00	2.00	131	169	2.0	1.0				143.3	106.00	110.00	
HCB7024C.T.P4S	120	180	28	2.00	2.00	131	169	2.0	1.0				143.3	78.00	81.50	
HCB7024E.T.P4S	120	180	28	2.00	2.00	131	169	2.0	1.0				143.3	73.50	76.50	
XCB7024C.T.P4S	120	180	28	2.00	2.00	131	169	2.0	1.0				143.3	173.00	81.50	
XCB7024E.T.P4S	120	180	28	2.00	2.00	131	169	2.0	1.0				143.3	163.00	76.50	
HS7024C.T.P4S	120	180	28	2.00	2.00	131	169	2.0	1.0				145.4	51.00	63.00	
HS7024E.T.P4S	120	180	28	2.00	2.00	131	169	2.0	1.0				145.4	48.00	58.50	
HC7024C.T.P4S	120	180	28	2.00	2.00	131	169	2.0	1.0				145.4	35.50	44.00	
HC7024E.T.P4S	120	180	28	2.00	2.00	131	169	2.0	1.0				145.4	33.50	41.50	
XC7024C.T.P4S	120	180	28	2.00	2.00	131	169	2.0	1.0				145.4	80.00	44.00	
XC7024E.T.P4S	120	180	28	2.00	2.00	131	169	2.0	1.0				145.4	75.00	41.50	
B7224C.T.P4S	120	215	40	2.10	2.10	140	195	2.1	2.1				158.0	204.00	196.00	
B7224E.T.P4S	120	215	40	2.10	2.10	140	195	2.1	2.1				158.0	196.00	186.00	
HCB7224C.T.P4S	120	215	40	2.10	2.10	140	195	2.1	2.1				158.0	140.00	137.00	
HCB7224E.T.P4S	120	215	40	2.10	2.10	140	195	2.1	2.1				158.0	134.00	129.00	

Designation examples:

Sealed design

B7024C.2RSD.T.P4S.UL

HSS7024E.T.P4S.UL

Hybrid ceramic design

HCB7024C.T.P4S.UL

HCB71824C.TPA.P4.UL

SPINDLE BEARINGS

B718..C/E, B719, B70, B72 HS719..C/E, HS70

C: Contact Angle $\alpha = 15^\circ$ / E: Contact Angle $\alpha = 25^\circ$

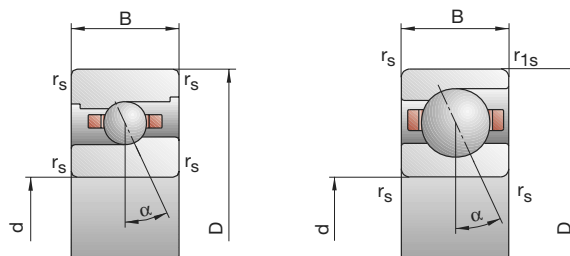

120

Attainable Speed	Grease	Oil minimal	Preloading Force F_V			Unloading Force K_{aE}			Axial Rigidity S_a			Sealed Design	Weight	Bearing Code
			L	M	H	L	M	H	L	M	H			
min ⁻¹			N						N/ μ m				kg	FAG
7500	12000		146	527	1119	445	1734	3956	80.1	141.0	206.3	–	0.5	B71824C.TPA.P4
7000	11000		184	779	1725	530	2323	5308	178.5	305.9	421.9	–	0.5	B71824E.TPA.P4
10000	17000		79	319	700	237	1015	2358	70.8	125.0	179.7	–	0.5	HCB71824C.TPA.P4
8500	14000		80	445	1049	231	1318	3188	151.4	279.6	388.1	–	0.5	HCB71824E.TPA.P4
7000	11000		408	1344	2773	1257	4462	9838	109.5	186.0	267.5	•	1.2	B71924C.T.P4S
6700	10000		591	2087	4388	1726	6291	13620	256.2	411.5	555.9	•	1.2	B71924E.T.P4S
9000	15000		212	742	1566	642	2370	5263	95.1	158.4	222.4	•	1.0	HCB71924C.T.P4S
8000	13000		277	1110	2421	811	3315	7395	222.7	365.9	492.3	•	1.0	HCB71924E.T.P4S
12000	19000		212	742	1566	642	2370	5263	95.1	158.4	222.4	•	1.0	XCB71924C.T.P4S
10000	17000		277	1110	2421	811	3315	7395	222.7	365.9	492.3	•	1.0	XCB71924E.T.P4S
9000	15000		127	382	764	374	1179	2462	77.6	121.2	164.9	•	1.3	HS71924C.T.P4S
8000	13000		207	621	1242	591	1806	3680	196.3	291.4	378.6	•	1.3	HS71924E.T.P4S
11000	18000		88	263	525	260	802	1654	76.7	116.7	155.7	•	1.3	HC71924C.T.P4S
9000	15000		143	428	856	413	1248	2528	196.6	288.6	371.6	•	1.3	HC71924E.T.P4S
14000	22000		88	263	525	260	802	1654	76.7	116.7	155.7	•	1.3	XC71924C.T.P4S
12000	19000		143	428	856	413	1248	2528	196.6	288.6	371.6	•	1.3	XC71924E.T.P4S
6700	10000		657	2107	4308	2035	7046	15410	123.7	208.9	300.3	•	2.1	B7024C.T.P4S
6300	9500		989	3317	6881	2896	10031	21490	291.7	461.2	621.8	•	2.1	B7024E.T.P4S
8500	14000		351	1175	2437	1068	3775	8244	108.3	178.0	248.9	•	1.8	HCB7024C.T.P4S
7500	12000		488	1782	3795	1434	5334	11621	257.6	410.6	548.6	•	1.8	HCB7024E.T.P4S
11000	18000		351	1175	2437	1068	3775	8244	108.3	178.0	248.9	•	1.8	XCB7024C.T.P4S
9500	16000		488	1782	3795	1434	5334	11621	257.6	410.6	548.6	•	1.8	XCB7024E.T.P4S
8500	14000		179	536	1072	530	1659	3480	82.1	128.0	175.0	•	2.3	HS7024C.T.P4S
7500	12000		288	863	1725	824	2511	5114	205.8	305.6	397.2	•	2.3	HS7024E.T.P4S
10000	17000		123	369	737	363	1128	2336	80.5	123.2	164.9	•	2.1	HC7024C.T.P4S
8500	14000		199	598	1196	575	1747	3543	205.8	303.1	390.8	•	2.1	HC7024E.T.P4S
13000	20000		123	369	737	363	1128	2336	80.5	123.2	164.9	•	2.1	XC7024C.T.P4S
11000	18000		199	598	1196	575	1747	3543	205.8	303.1	390.8	•	2.1	XC7024E.T.P4S
6000	9000		1269	3957	8038	3947	13275	28900	140.0	233.9	335.7	–	5.5	B7224C.T.P4S
5300	8000		2003	6418	13107	5898	19505	41076	335.4	522.0	699.7	–	5.5	B7224E.T.P4S
7500	12000		684	2190	4478	2088	7051	15167	122.8	198.5	275.8	–	4.4	HCB7224C.T.P4S
6300	9500		1047	3506	7288	3085	10550	22362	301.6	467.4	618.6	–	4.4	HCB7224E.T.P4S

X-life ultra design
XC7024E.T.P4S.UL
XCB7024C.T.P4S.UL

See Bearing Code, page 178

SPINDLE BEARINGS

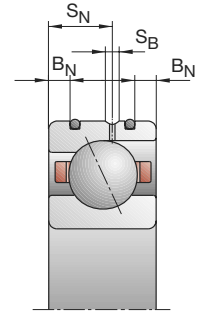
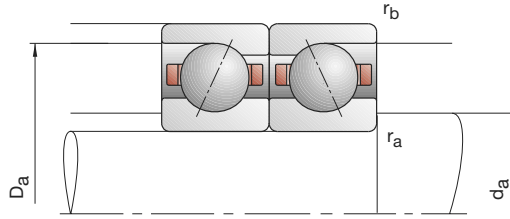
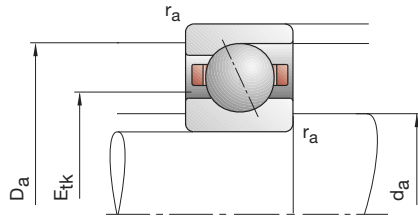

Bearing Code	Dimensions					Abutment Dimensions				DLR Dimensions			Load Ratings		
	d	D	B	r _{smin}	r _{1smin}	d _a h12	D _a H12	r _a max	r _b max	B _N	S _N	S _B	E _{tk}	C _{dyn}	C _{0stat}
FAG	mm													kN	
B71826C.TPA.P4	130	165	18	1.10	0.60	137	158	1.1	0.6				143.1	42.50	51.00
B71826E.TPA.P4	130	165	18	1.10	0.60	137	158	1.1	0.6				143.1	40.00	48.00
HCB71826C.TPA.P4	130	165	18	1.10	0.60	137	158	1.1	0.6				143.1	29.00	35.50
HCB71826E.TPA.P4	130	165	18	1.10	0.60	137	158	1.1	0.6				143.1	27.50	33.50
B71926C.T.P4S	130	180	24	1.50	1.50	139	171	0.6	0.6				150.2	86.50	100.00
B71926E.T.P4S	130	180	24	1.50	1.50	139	171	0.6	0.6				150.2	81.50	95.00
HCB71926C.T.P4S	130	180	24	1.50	1.50	139	171	0.6	0.6				150.2	60.00	69.50
HCB71926E.T.P4S	130	180	24	1.50	1.50	139	171	0.6	0.6				150.2	57.00	65.50
XCB71926C.T.P4S	130	180	24	1.50	1.50	139	171	0.6	0.6				150.2	134.00	69.50
XCB71926E.T.P4S	130	180	24	1.50	1.50	139	171	0.6	0.6				150.2	127.00	65.50
HS71926C.T.P4S	130	180	24	1.50	1.50	139	171	0.6	0.6				151.0	41.50	56.00
HS71926E.T.P4S	130	180	24	1.50	1.50	139	171	0.6	0.6				151.0	39.00	52.00
HC71926C.T.P4S	130	180	24	1.50	1.50	139	171	0.6	0.6				151.0	29.00	39.00
HC71926E.T.P4S	130	180	24	1.50	1.50	139	171	0.6	0.6				151.0	27.00	36.50
XC71926C.T.P4S	130	180	24	1.50	1.50	139	171	0.6	0.6				151.0	64.00	39.00
XC71926E.T.P4S	130	180	24	1.50	1.50	139	171	0.6	0.6				151.0	60.00	36.50
B7026C.T.P4S	130	200	33	2.00	2.00	142	189	2.0	1.0				157.2	143.00	150.00
B7026E.T.P4S	130	200	33	2.00	2.00	142	189	2.0	1.0				157.2	137.00	143.00
HCB7026C.T.P4S	130	200	33	2.00	2.00	142	189	2.0	1.0				157.2	100.00	104.00
HCB7026E.T.P4S	130	200	33	2.00	2.00	142	189	2.0	1.0				157.2	95.00	98.00
XCB7026C.T.P4S	130	200	33	2.00	2.00	142	189	2.0	1.0				157.2	224.00	104.00
XCB7026E.T.P4S	130	200	33	2.00	2.00	142	189	2.0	1.0				157.2	212.00	98.00
HS7026C.T.P4S	130	200	33	2.00	2.00	142	189	2.0	1.0				159.7	65.50	83.00
HS7026E.T.P4S	130	200	33	2.00	2.00	142	189	2.0	1.0				159.7	62.00	78.00
HC7026C.T.P4S	130	200	33	2.00	2.00	142	189	2.0	1.0				159.7	45.50	58.50
HC7026E.T.P4S	130	200	33	2.00	2.00	142	189	2.0	1.0				159.7	42.50	54.00
XC7026C.T.P4S	130	200	33	2.00	2.00	142	189	2.0	1.0				159.7	102.00	58.50
XC7026E.T.P4S	130	200	33	2.00	2.00	142	189	2.0	1.0				159.7	95.00	54.00
B7226C.T.P4S	130	230	40	3.00	3.00	148	211.5	2.5	2.5				170.5	212.00	216.00
B7226E.T.P4S	130	230	40	3.00	3.00	148	211.5	2.5	2.5				170.5	204.00	204.00
HCB7226C.T.P4S	130	230	40	3.00	3.00	148	211.5	2.5	2.5				170.5	146.00	150.00
HCB7226E.T.P4S	130	230	40	3.00	3.00	148	211.5	2.5	2.5				170.5	140.00	143.00

Designation examples:

Sealed design

B7026C.2RSD.T.P4S.UL

HSS7026E.T.P4S.UL

Hybrid ceramic design

HCB7026C.T.P4S.UL

HCB71826C.TPA.P4.UL

SPINDLE BEARINGS

B718..C/E, B719, B70, B72 HS719..C/E, HS70

C: Contact Angle $\alpha = 15^\circ$ / E: Contact Angle $\alpha = 25^\circ$

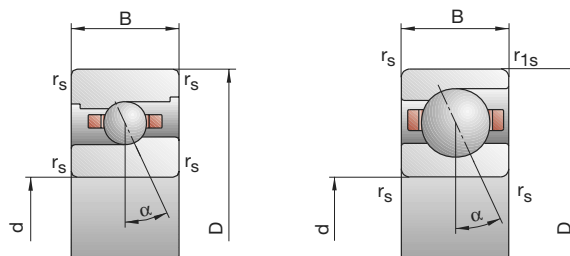

Attainable Speed	Preloading Force			Unloading Force			Axial Rigidity			Sealed Design	Weight	Bearing Code	
	Grease	Oil minimal	F_V	K_{aE}	S_a	L	M	H	L				M
min ⁻¹		N						N/ μ m			kg	FAG	
7000	11000	208	723	1523	640	2413	5455	93.6	163.8	239.5	–	0.8	B71826C.TPA.P4
6300	9500	277	1092	2378	805	3288	7397	211.6	354.6	487.6	–	0.8	B71826E.TPA.P4
9000	15000	119	452	975	360	1456	3330	84.2	146.5	210.2	–	0.8	HCB71826C.TPA.P4
7500	12000	137	653	1493	399	1952	4574	187.2	328.8	452.6	–	0.8	HCB71826E.TPA.P4
6700	10000	489	1600	3291	1508	5317	11665	117.5	199.0	285.6	•	1.5	B71926C.T.P4S
6000	9000	714	2477	5193	2087	7472	16123	275.6	439.7	593.2	•	1.5	B71926E.T.P4S
8500	14000	258	887	1858	781	2837	6249	102.6	169.8	237.6	•	1.3	HCB71926C.T.P4S
7000	11000	349	1354	2923	1022	4049	8917	242.7	395.0	529.1	•	1.3	HCB71926E.T.P4S
11000	18000	258	887	1858	781	2837	6249	102.6	169.8	237.6	•	1.3	XCB71926C.T.P4S
9500	16000	349	1354	2923	1022	4049	8917	242.7	395.0	529.1	•	1.3	XCB71926E.T.P4S
8500	14000	145	436	871	427	1345	2804	82.1	128.1	174.1	•	1.8	HS71926C.T.P4S
7000	11000	238	713	1426	680	2074	4214	208.3	308.9	400.9	•	1.8	HS71926E.T.P4S
9500	16000	100	300	600	295	914	1889	80.9	123.3	164.6	•	1.7	HC71926C.T.P4S
8000	13000	163	488	975	470	1423	2879	207.5	305.2	392.7	•	1.7	HC71926E.T.P4S
12000	19000	100	300	600	295	914	1889	80.9	123.3	164.6	•	1.7	XC71926C.T.P4S
11000	18000	163	488	975	470	1423	2879	207.5	305.2	392.7	•	1.7	XC71926E.T.P4S
6000	9000	857	2720	5545	2658	9109	19842	137.9	231.8	332.6	•	3.2	B7026C.T.P4S
5600	8500	1322	4358	8972	3877	13200	27997	327.9	515.3	692.2	•	3.2	B7026E.T.P4S
7500	12000	460	1518	3139	1402	4882	10629	120.9	197.6	275.9	•	2.7	HCB7026C.T.P4S
6700	10000	673	2379	5019	1976	7133	15398	292.4	461.5	614.7	•	2.7	HCB7026E.T.P4S
10000	17000	460	1518	3139	1402	4882	10629	120.9	197.6	275.9	•	2.7	XCB7026C.T.P4S
8500	14000	673	2379	5019	1976	7133	15398	292.4	461.5	614.7	•	2.7	XCB7026E.T.P4S
7500	12000	228	683	1367	675	2113	4422	92.9	144.9	197.6	•	3.7	HS7026C.T.P4S
6700	10000	368	1104	2208	1053	3212	6547	233.4	346.6	450.6	•	3.7	HS7026E.T.P4S
9000	15000	159	476	951	470	1455	3007	91.8	140.1	187.3	•	3.5	HC7026C.T.P4S
7500	12000	257	771	1541	741	2254	4567	234.1	345.0	444.5	•	3.5	HC7026E.T.P4S
12000	19000	159	476	951	470	1455	3007	91.8	140.1	187.3	•	3.5	XC7026C.T.P4S
10000	17000	257	771	1541	741	2254	4567	234.1	345.0	444.5	•	3.5	XC7026E.T.P4S
5600	8500	1316	4108	8347	4084	13741	29821	147.9	246.8	353.2	–	6.3	B7226C.T.P4S
5000	7500	2079	6671	13628	6116	20247	42633	355.2	552.6	740.1	–	6.3	B7226E.T.P4S
7000	11000	719	2304	4709	2193	7407	15918	130.6	210.9	292.8	–	5.2	HCB7226C.T.P4S
6000	9000	1079	3624	7521	3177	10892	23040	318.7	494.0	652.9	–	5.2	HCB7226E.T.P4S

X-life ultra design
XC7026E.T.P4S.UL
XCB7026C.T.P4S.UL

See Bearing Code, page 178

SPINDLE BEARINGS

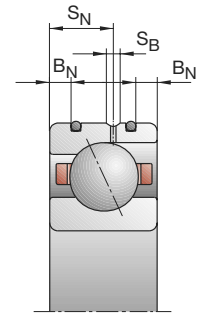
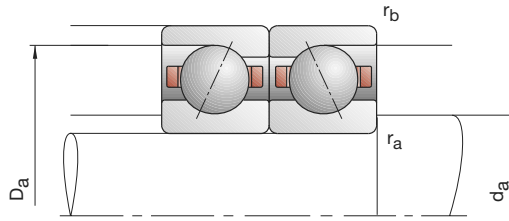
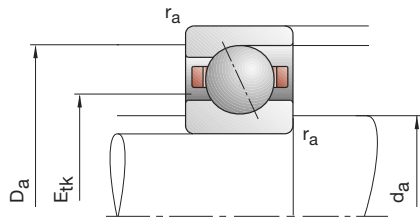

Bearing Code	Dimensions					Abutment Dimensions				DLR Dimensions			Load Ratings		
	d	D	B	r _{smin}	r _{1smin}	d _a h12	D _a H12	r _a max	r _b max	B _N	S _N	S _B	E _{tk}	C _{dyn}	C _{0stat}
FAG	mm													kN	
B71828C.TPA.P4	140	175	18	1.10	0.60	147	168	1.1	0.6				153.1	43.00	54.00
B71828E.TPA.P4	140	175	18	1.10	0.60	147	168	1.1	0.6				153.1	40.50	51.00
HCB71828C.TPA.P4	140	175	18	1.10	0.60	147	168	1.1	0.6				153.1	30.00	38.00
HCB71828E.TPA.P4	140	175	18	1.10	0.60	147	168	1.1	0.6				153.1	28.00	35.50
B71928C.T.P4S	140	190	24	1.50	1.50	149	181	0.6	0.6				160.2	90.00	108.00
B71928E.T.P4S	140	190	24	1.50	1.50	149	181	0.6	0.6				160.2	85.00	102.00
HCB71928C.T.P4S	140	190	24	1.50	1.50	149	181	0.6	0.6				160.2	62.00	76.50
HCB71928E.T.P4S	140	190	24	1.50	1.50	149	181	0.6	0.6				160.2	58.50	71.00
XCB71928C.T.P4S	140	190	24	1.50	1.50	149	181	0.6	0.6				160.2	137.00	76.50
XCB71928E.T.P4S	140	190	24	1.50	1.50	149	181	0.6	0.6				160.2	129.00	71.00
B7028C.T.P4S	140	210	33	2.00	2.00	152	199	2.0	1.0				167.2	146.00	160.00
B7028E.T.P4S	140	210	33	2.00	2.00	152	199	2.0	1.0				167.2	140.00	150.00
HCB7028C.T.P4S	140	210	33	2.00	2.00	152	199	2.0	1.0				167.2	102.00	110.00
HCB7028E.T.P4S	140	210	33	2.00	2.00	152	199	2.0	1.0				167.2	96.50	104.00
XCB7028C.T.P4S	140	210	33	2.00	2.00	152	199	2.0	1.0				167.2	228.00	110.00
XCB7028E.T.P4S	140	210	33	2.00	2.00	152	199	2.0	1.0				167.2	216.00	104.00
B7228C.T.P4S	140	250	42	3.00	3.00	163	226.5	2.5	2.5				185.5	220.00	232.00
B7228E.T.P4S	140	250	42	3.00	3.00	163	226.5	2.5	2.5				185.5	212.00	224.00
HCB7228C.T.P4S	140	250	42	3.00	3.00	163	226.5	2.5	2.5				185.5	153.00	163.00
HCB7228E.T.P4S	140	250	42	3.00	3.00	163	226.5	2.5	2.5				185.5	146.00	156.00

Designation examples:

Sealed design

B7028C.2RSD.T.P4S.UL

Hybrid ceramic design

HCB7028C.T.P4S.UL

HCB71828C.TPA.P4.UL

SPINDLE BEARINGS

B718..C/E, B719, B70, B72 HS719..C/E, HS70

C: Contact Angle $\alpha = 15^\circ$ / E: Contact Angle $\alpha = 25^\circ$

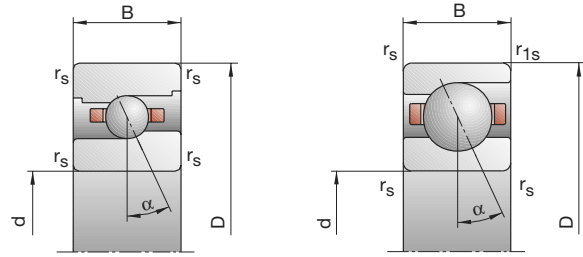

Attainable Speed		Preloading Force			Unloading Force			Axial Rigidity			Sealed Design	Weight	Bearing Code
Grease	Oil minimal	L	M	H	L	M	H	L	M	H			
min ⁻¹		N						N/μm			kg	FAG	
6300	9500	208	728	1536	638	2418	5469	97.1	169.7	247.6	–	0.8	B71828C.TPA.P4
6000	9000	275	1097	2397	798	3296	7435	219.6	369.0	507.2	–	0.8	B71828E.TPA.P4
8000	13000	121	466	1007	366	1498	3430	88.1	153.7	220.4	–	0.8	HCB71828C.TPA.P4
7000	11000	135	659	1511	393	1968	4620	194.0	343.2	472.1	–	0.8	HCB71828E.TPA.P4
6000	9000	506	1661	3412	1557	5502	12044	124.7	210.9	301.9	•	1.6	B71928C.T.P4S
5600	8500	740	2576	5405	2162	7760	16750	293.3	467.9	630.8	•	1.6	B71928E.T.P4S
7500	12000	266	919	1928	804	2932	6464	108.9	180.1	251.8	•	1.4	HCB71928C.T.P4S
6700	10000	354	1387	3002	1036	4142	9141	256.5	418.2	560.2	•	1.4	HCB71928E.T.P4S
10000	17000	266	919	1928	804	2932	6464	108.9	180.1	251.8	•	1.4	XCB71928C.T.P4S
8500	14000	354	1387	3002	1036	4142	9141	256.5	418.2	560.2	•	1.4	XCB71928E.T.P4S
5600	8500	873	2775	5657	2703	9270	20180	142.9	240.1	343.9	•	3.4	B7028C.T.P4S
5000	7500	1345	4446	9159	3941	13450	28537	340.3	534.9	718.2	•	3.4	B7028E.T.P4S
7000	11000	480	1583	3273	1463	5089	11075	126.7	206.9	288.7	•	2.8	HCB7028C.T.P4S
6300	9500	687	2434	5127	2016	7292	15712	304.0	479.8	638.4	•	2.8	HCB7028E.T.P4S
9500	16000	480	1583	3273	1463	5089	11075	126.7	206.9	288.7	•	2.8	XCB7028C.T.P4S
8000	13000	687	2434	5127	2016	7292	15712	304.0	479.8	638.4	•	2.8	XCB7028E.T.P4S
5000	7500	1363	4259	8634	4222	14208	30737	155.8	259.6	370.7	–	8.1	B7228C.T.P4S
4500	6700	2154	6923	14150	6331	20931	44194	374.8	582.4	780.4	–	8.1	B7228E.T.P4S
6300	9500	747	2397	4901	2276	7692	16528	137.9	222.5	308.6	–	6.8	HCB7228C.T.P4S
5300	8000	1133	3811	7910	3335	11447	24211	338.1	524.1	692.5	–	6.8	HCB7228E.T.P4S

X-life ultra design
XC7028E.T.P4S.UL
XCB7028C.T.P4S.UL

See Bearing Code, page 178

SPINDLE BEARINGS

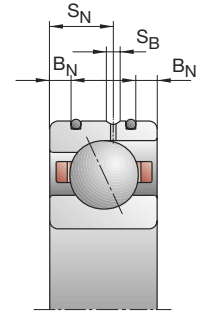
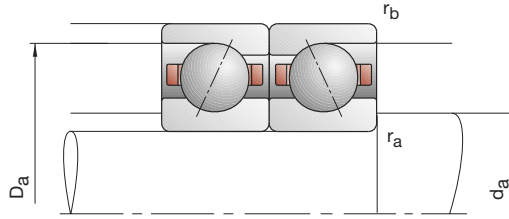
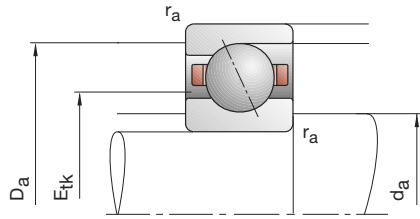

Bearing Code	Dimensions					Abutment Dimensions				DLR Dimensions			Load Ratings		
	d	D	B	r _{smin}	r _{1smin}	d _a h12	D _a H12	r _a max	r _b max	B _N	S _N	S _B	E _{tk}	C _{dyn}	C _{0stat}
FAG	mm													kN	
B71830C.TPA.P4	150	190	20	1.10	0.60	158	182	1.1	0.6				164.8	56.00	69.50
B71830E.TPA.P4	150	190	20	1.10	0.60	158	182	1.1	0.6				164.8	52.00	64.00
HCB71830C.TPA.P4	150	190	20	1.10	0.60	158	182	1.1	0.6				164.8	38.00	48.00
HCB71830E.TPA.P4	150	190	20	1.10	0.60	158	182	1.1	0.6				164.8	36.00	45.00
B71930C.T.P4S	150	210	28	2.00	1.00	160	199	1.0	1.0				174.3	122.00	143.00
B71930E.T.P4S	150	210	28	2.00	1.00	160	199	1.0	1.0				174.3	114.00	134.00
HCB71930C.T.P4S	150	210	28	2.00	1.00	160	199	1.0	1.0				174.3	85.00	100.00
HCB71930E.T.P4S	150	210	28	2.00	1.00	160	199	1.0	1.0				174.3	80.00	95.00
XCB71930C.T.P4S	150	210	28	2.00	1.00	160	199	1.0	1.0				174.3	190.00	100.00
XCB71930E.T.P4S	150	210	28	2.00	1.00	160	199	1.0	1.0				174.3	180.00	95.00
B7030C.T.P4S	150	225	35	2.10	2.10	163	213	2.1	1.0				178.5	183.00	193.00
B7030E.T.P4S	150	225	35	2.10	2.10	163	213	2.1	1.0				178.5	173.00	186.00
HCB7030C.T.P4S	150	225	35	2.10	2.10	163	213	2.1	1.0				178.5	127.00	137.00
HCB7030E.T.P4S	150	225	35	2.10	2.10	163	213	2.1	1.0				178.5	120.00	129.00
XCB7030C.T.P4S	150	225	35	2.10	2.10	163	213	2.1	1.0				178.5	285.00	137.00
XCB7030E.T.P4S	150	225	35	2.10	2.10	163	213	2.1	1.0				178.5	270.00	129.00
B7230C.T.P4S	150	270	45	3.00	3.00	178	241.5	2.5	2.5				200.5	228.00	255.00
B7230E.T.P4S	150	270	45	3.00	3.00	178	241.5	2.5	2.5				200.5	216.00	240.00
HCB7230C.T.P4S	150	270	45	3.00	3.00	178	241.5	2.5	2.5				200.5	156.00	176.00
HCB7230E.T.P4S	150	270	45	3.00	3.00	178	241.5	2.5	2.5				200.5	150.00	166.00

Designation examples:

Hybrid ceramic design

HCB7030C.T.P4S.UL

HCB71830C.TPA.P4.UL

X-life ultra design

XC7030E.T.P4S.UL

XCB7030C.T.P4S.UL

SPINDLE BEARINGS

B718..C/E, B719, B70, B72 HS719..C/E, HS70

C: Contact Angle $\alpha = 15^\circ$ / E: Contact Angle $\alpha = 25^\circ$

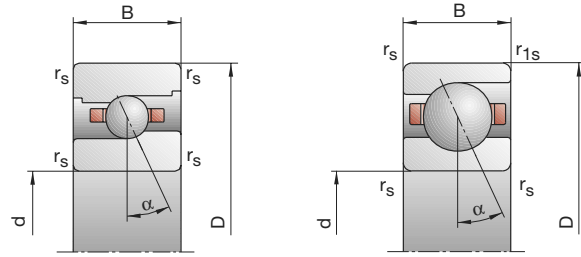

Attainable Speed		Preloading Force F_V			Unloading Force K_{aE}			Axial Rigidity S_a			Sealed Design	Weight kg	Bearing Code FAG
Grease min ⁻¹	Oil minimal	L	M	H	L	M	H	L	M	H			
6000	9000	281	955	1995	866	3180	7140	108.7	188.1	274.0	–	1.1	B71830C.TPA.P4
5300	8000	386	1465	3145	1124	4405	9789	248.3	410.2	561.3	–	1.1	B71830E.TPA.P4
7500	12000	170	624	1332	516	2015	4559	100.1	172.0	245.8	–	1.1	HCB71830C.TPA.P4
6300	9500	202	891	1994	588	2660	6112	224.3	383.5	523.9	–	1.1	HCB71830E.TPA.P4
5600	8500	710	2286	4680	2188	7583	16579	141.4	237.8	340.6	–	2.5	B71930C.T.P4S
5000	7500	1046	3541	7369	3055	10662	22894	332.6	525.8	707.9	–	2.5	B71930E.T.P4S
7000	11000	375	1261	2622	1137	4024	8792	123.6	202.5	282.3	–	2.1	HCB71930C.T.P4S
6000	9000	519	1925	4116	1523	5747	12558	294.8	471.4	629.5	–	2.1	HCB71930E.T.P4S
9000	15000	375	1261	2622	1137	4024	8792	123.6	202.5	282.3	–	2.1	XCB71930C.T.P4S
8000	13000	519	1925	4116	1523	5747	12558	294.8	471.4	629.5	–	2.1	XCB71930E.T.P4S
5300	8000	1111	3503	7142	3449	11700	25557	157.2	263.0	377.6	–	4.1	B7030C.T.P4S
4800	7000	1705	5555	11417	5003	16818	35626	373.2	583.4	782.8	–	4.1	B7030E.T.P4S
6700	10000	601	1960	4031	1829	6289	13611	138.1	224.5	312.6	–	3.3	HCB7030C.T.P4S
5600	8500	898	3106	6501	2639	9320	19942	336.8	527.5	700.2	–	3.3	HCB7030E.T.P4S
8500	14000	601	1960	4031	1829	6289	13611	138.1	224.5	312.6	–	3.3	XCB7030C.T.P4S
7500	12000	898	3106	6501	2639	9320	19942	336.8	527.5	700.2	–	3.3	XCB7030E.T.P4S
4500	6700	1411	4410	8942	4364	14677	31741	163.8	272.4	388.5	–	10.3	B7230C.T.P4S
4000	6000	2186	7023	14400	6418	21195	44874	391.6	607.6	814.2	–	10.3	B7230E.T.P4S
5600	8500	768	2470	5053	2336	7909	16996	144.6	233.3	323.2	–	9.0	HCB7230C.T.P4S
5000	7500	1144	3861	8025	3364	11580	24520	352.8	547.0	722.5	–	9.0	HCB7230E.T.P4S

See Bearing Code, page 178

SPINDLE BEARINGS

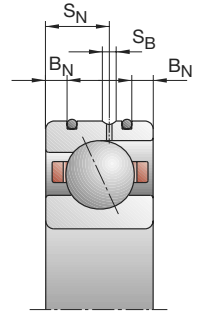
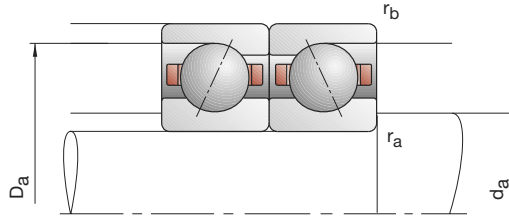
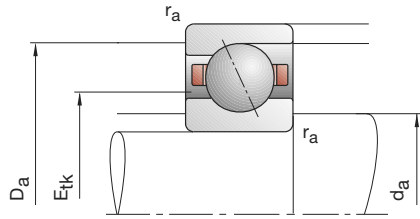

Bearing Code	Dimensions					Abutment Dimensions				DLR Dimensions			Load Ratings		
	d	D	B	r _{smin}	r _{1smin}	d _a h12	D _a H12	r _a max	r _b max	B _N	S _N	S _B	E _{tk}	C _{dyn}	C _{0stat}
FAG	mm													kN	
B71832C.TPA.P4	160	200	20	1.10	0.60	168	192	1.1	0.6				174.8	57.00	73.50
B71832E.TPA.P4	160	200	20	1.10	0.60	168	192	1.1	0.6				174.8	54.00	68.00
HCB71832C.TPA.P4	160	200	20	1.10	0.60	168	192	1.1	0.6				174.8	39.00	51.00
HCB71832E.TPA.P4	160	200	20	1.10	0.60	168	192	1.1	0.6				174.8	37.50	48.00
B71932C.T.P4S	160	220	28	2.00	1.00	170	209	1.0	1.0				184.3	125.00	150.00
B71932E.T.P4S	160	220	28	2.00	1.00	170	209	1.0	1.0				184.3	116.00	140.00
HCB71932C.T.P4S	160	220	28	2.00	1.00	170	209	1.0	1.0				184.3	85.00	104.00
HCB71932E.T.P4S	160	220	28	2.00	1.00	170	209	1.0	1.0				184.3	80.00	98.00
XCB71932C.T.P4S	160	220	28	2.00	1.00	170	209	1.0	1.0				184.3	190.00	104.00
XCB71932E.T.P4S	160	220	28	2.00	1.00	170	209	1.0	1.0				184.3	180.00	98.00
B7032C.T.P4S	160	240	38	2.10	2.10	174	228	2.0	1.0				191.0	190.00	208.00
B7032E.T.P4S	160	240	38	2.10	2.10	174	228	2.0	1.0				191.0	176.00	196.00
HCB7032C.T.P4S	160	240	38	2.10	2.10	174	228	2.0	1.0				191.0	129.00	143.00
HCB7032E.T.P4S	160	240	38	2.10	2.10	174	228	2.0	1.0				191.0	122.00	137.00
XCB7032C.T.P4S	160	240	38	2.10	2.10	174	228	2.0	1.0				191.0	290.00	143.00
XCB7032E.T.P4S	160	240	38	2.10	2.10	174	228	2.0	1.0				191.0	270.00	137.00
B7232C.T.P4S	160	290	48	3.00	3.00	191	259	2.5	2.5				215.5	245.00	285.00
B7232E.T.P4S	160	290	48	3.00	3.00	191	259	2.5	2.5				215.5	232.00	270.00
HCB7232C.T.P4S	160	290	48	3.00	3.00	191	259	2.5	2.5				215.5	170.00	200.00
HCB7232E.T.P4S	160	290	48	3.00	3.00	191	259	2.5	2.5				215.5	160.00	190.00
B71834C.TPA.P4	170	215	22	1.10	0.60	179	206	1.1	0.6				186.7	68.00	88.00
B71834E.TPA.P4	170	215	22	1.10	0.60	179	206	1.1	0.6				186.7	64.00	81.50
HCB71834C.TPA.P4	170	215	22	1.10	0.60	179	206	1.1	0.6				186.7	47.50	61.00
HCB71834E.TPA.P4	170	215	22	1.10	0.60	179	206	1.1	0.6				186.7	45.00	57.00
B71934C.T.P4S	170	230	28	2.00	1.50	180	219	1.0	1.0				194.3	129.00	163.00
B71934E.T.P4S	170	230	28	2.00	1.50	180	219	1.0	1.0				194.3	122.00	150.00
HCB71934C.T.P4S	170	230	28	2.00	1.50	180	219	1.0	1.0				194.3	88.00	114.00
HCB71934E.T.P4S	170	230	28	2.00	1.50	180	219	1.0	1.0				194.3	83.00	106.00
B7034C.T.P4S	170	260	42	2.10	2.10	185	246	2.0	1.0				203.8	236.00	270.00
B7034E.T.P4S	170	260	42	2.10	2.10	185	246	2.0	1.0				203.8	224.00	255.00
B7234C.T.P4S	170	310	52	4.00	4.00	205	275	3.0	3.0				228.6	300.00	360.00
B7234E.T.P4S	170	310	52	4.00	4.00	205	275	3.0	3.0				228.6	280.00	345.00
Designation examples:						Hybrid ceramic design					X-life ultra design				
						HCB7032C.T.P4S.UL					XC7032E.T.P4S.UL				
						HCB71832C.TPA.P4.UL					XCB7032C.T.P4S.UL				

SPINDLE BEARINGS

B718..C/E, B719, B70, B72 HS719..C/E, HS70

C: Contact Angle $\alpha = 15^\circ$ / E: Contact Angle $\alpha = 25^\circ$

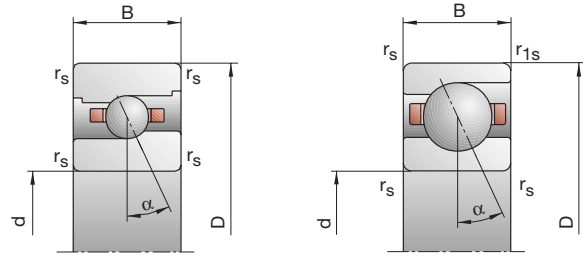

160
170

Attainable Speed		Preloading Force F_V			Unloading Force K_{aE}			Axial Rigidity S_a			Sealed Design	Weight	Bearing Code
Grease	Oil minimal	L	M	H	L	M	H	L	M	H		kg	FAG
min ⁻¹		N						N/μm					
5600	8500	283	969	2032	869	3214	7238	113.0	195.6	284.9	–	1.2	B71832C.TPA.P4
5000	7500	389	1485	3194	1132	4457	9917	259.3	428.3	585.7	–	1.2	B71832E.TPA.P4
7000	11000	171	629	1349	518	2024	4596	104.2	178.7	255.3	–	1.2	HCB71832C.TPA.P4
6000	9000	203	911	2043	591	2717	6253	234.1	402.1	549.2	–	1.2	HCB71832E.TPA.P4
5000	7500	727	2341	4793	2238	7755	16952	146.1	245.5	351.4	–	2.7	B71932C.T.P4S
4800	7000	1061	3597	7491	3097	10821	23248	342.8	541.8	729.2	–	2.7	B71932E.T.P4S
6700	10000	382	1286	2676	1157	4099	8959	127.5	208.8	290.9	–	2.2	HCB71932C.T.P4S
5600	8500	529	1965	4204	1552	5864	12818	304.5	487.0	650.1	–	2.2	HCB71932E.T.P4S
8500	14000	382	1286	2676	1157	4099	8959	127.5	208.8	290.9	–	2.2	XCB71932C.T.P4S
7500	12000	529	1965	4204	1552	5864	12818	304.5	487.0	650.1	–	2.2	XCB71932E.T.P4S
4800	7000	1152	3635	7412	3573	12127	26413	164.1	274.5	393.4	–	5.1	B7032C.T.P4S
4300	6300	1728	5642	11602	5066	17061	36142	386.8	604.6	810.7	–	5.1	B7032E.T.P4S
6000	9000	624	2034	4184	1898	6521	14111	144.4	234.6	326.4	–	4.3	HCB7032C.T.P4S
5300	8000	911	3160	6621	2676	9473	20288	349.4	547.3	726.5	–	4.3	HCB7032E.T.P4S
8000	13000	624	2034	4184	1898	6521	14111	144.4	234.6	326.4	–	4.3	XCB7032C.T.P4S
6700	10000	911	3160	6621	2676	9473	20288	349.4	547.3	726.5	–	4.3	XCB7032E.T.P4S
4300	6300	1513	4734	9601	4669	15702	33935	179.9	298.6	425.1	–	13.0	B7232C.T.P4S
3800	5600	2339	7529	15450	6844	22687	48049	430.4	668.0	894.5	–	13.0	B7232E.T.P4S
5300	8000	832	2676	5478	2528	8552	18377	159.6	257.2	356.0	–	11.6	HCB7232C.T.P4S
4500	6700	1231	4167	8669	3618	12488	26454	389.0	603.5	796.8	–	11.6	HCB7232E.T.P4S
5000	7500	357	1199	2492	1097	3988	8875	122.5	210.9	305.7	–	1.6	B71834C.TPA.P4
4500	6700	499	1842	3924	1451	5538	12172	282.1	461.1	627.9	–	1.6	B71834E.TPA.P4
6300	9500	216	772	1638	654	2485	5597	112.6	191.4	272.7	–	1.6	HCB71834C.TPA.P4
5600	8500	274	1148	2539	799	3431	7770	258.7	434.4	590.4	–	1.6	HCB71834E.TPA.P4
4800	7000	747	2410	4941	2295	7954	17399	154.3	258.7	369.9	–	2.8	B71934C.T.P4S
4500	6700	1111	3777	7870	3242	11353	24396	365.5	577.8	777.2	–	2.8	B71934E.T.P4S
6000	9000	392	1328	2765	1186	4222	9226	134.9	220.8	307.2	–	2.4	HCB71934C.T.P4S
5300	8000	542	2028	4349	1589	6046	13242	322.2	516.2	689.2	–	2.4	HCB71934E.T.P4S
4500	6700	1458	4562	9252	4504	15154	32763	171.7	285.2	406.4	–	6.7	B7034C.T.P4S
4000	6000	2263	7276	14926	6641	21942	46466	411.2	637.9	854.5	–	6.7	B7034E.T.P4S
4000	6000	1878	5842	11825	5792	19336	41658	190.3	314.3	446.1	–	16.0	B7234C.T.P4S
3600	5300	2879	9183	18737	8424	27661	58033	454.6	702.4	936.0	–	16.0	B7234E.T.P4S

See Bearing Code, page 178

SPINDLE BEARINGS

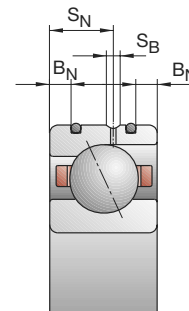
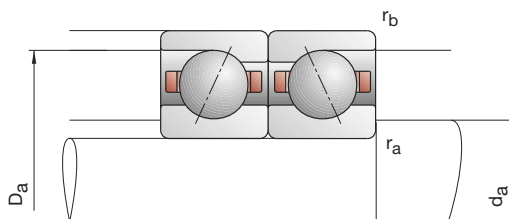
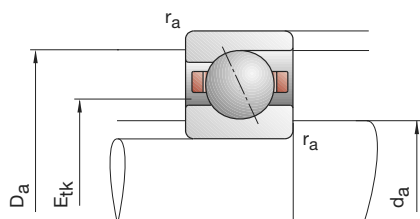

Bearing Code	Dimensions					Abutment Dimensions				DLR Dimensions			Load Ratings		
	d	D	B	r _{smin}	r _{1smin}	d _a h12	D _a H12	r _a max	r _b max	B _N	S _N	S _B	E _{tk}	C _{dyn}	C _{0stat}
FAG	mm													kN	
B71836C.TPA.P4	180	225	22	1.10	0.60	189	216	1.1	0.6				196.7	71.00	93.00
B71836E.TPA.P4	180	225	22	1.10	0.60	189	216	1.1	0.6				196.7	67.00	86.50
HCB71836C.TPA.P4	180	225	22	1.10	0.60	189	216	1.1	0.6				196.7	49.00	65.50
HCB71836E.TPA.P4	180	225	22	1.10	0.60	189	216	1.1	0.6				196.7	45.50	60.00
B71936C.T.P4S	180	250	33	2.00	1.00	192	238	1.0	1.0				208.3	163.00	204.00
B71936E.T.P4S	180	250	33	2.00	1.00	192	238	1.0	1.0				208.3	156.00	193.00
HCB71936C.T.P4S	180	250	33	2.00	1.00	192	238	1.0	1.0				208.3	114.00	143.00
HCB71936E.T.P4S	180	250	33	2.00	1.00	192	238	1.0	1.0				208.3	106.00	134.00
B7036C.T.P4S	180	280	46	2.10	2.10	196	264	2.0	1.0				218.8	245.00	285.00
B7036E.T.P4S	180	280	46	2.10	2.10	196	264	2.0	1.0				218.8	232.00	275.00
B7236C.T.P4S	180	320	52	4.00	4.00	213.5	286.5	3.0	3.0				238.6	305.00	390.00
B7236E.T.P4S	180	320	52	4.00	4.00	213.5	286.5	3.0	3.0				238.6	290.00	365.00
B71838C.TPA.P4	190	240	24	1.50	0.60	201	229	1.5	0.6				208.9	80.00	108.00
B71838E.TPA.P4	190	240	24	1.50	0.60	201	229	1.5	0.6				208.9	75.00	100.00
HCB71838C.TPA.P4	190	240	24	1.50	0.60	201	229	1.5	0.6				208.9	55.00	75.00
HCB71838E.TPA.P4	190	240	24	1.50	0.60	201	229	1.5	0.6				208.9	52.00	69.50
B71938C.T.P4S	190	260	33	2.00	1.00	202	247	1.0	1.0				218.3	166.00	212.00
B71938E.T.P4S	190	260	33	2.00	1.00	202	247	1.0	1.0				218.3	156.00	200.00
HCB71938C.T.P4S	190	260	33	2.00	1.00	202	247	1.0	1.0				218.3	116.00	150.00
HCB71938E.T.P4S	190	260	33	2.00	1.00	202	247	1.0	1.0				218.3	108.00	140.00
B7038C.T.P4S	190	290	46	2.10	2.10	206	274	2.0	1.0				228.8	250.00	305.00
B7038E.T.P4S	190	290	46	2.10	2.10	206	274	2.0	1.0				228.8	236.00	290.00
B7238C.T.P4S	190	340	55	4.00	4.00	223.5	306.5	3.0	3.0				253.6	315.00	415.00
B7238E.T.P4S	190	340	55	4.00	4.00	223.5	306.5	3.0	3.0				253.6	300.00	390.00

Designation examples:

Hybrid ceramic design

See Bearing Code, page 178

HCB71936C.T.P4S.UL

HCB71836C.TPA.P4.UL

SPINDLE BEARINGS

B718..C/E, B719, B70, B72 HS719..C/E, HS70

C: Contact Angle $\alpha = 15^\circ$ / E: Contact Angle $\alpha = 25^\circ$

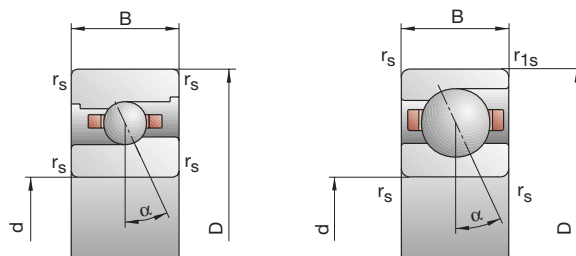

180
190

Attainable Speed		Preloading Force F_V			Unloading Force K_{aE}			Axial Rigidity S_a			Sealed Design	Weight kg	Bearing Code FAG
Grease min ⁻¹	Oil minimal	L	M	H	L	M	H	L	M	H			
4800	7000	372	1250	2600	1142	4151	9241	129.2	222.3	322.0	–	1.7	B71836C.TPA.P4
4300	6300	520	1919	4103	1511	5766	12717	297.8	486.8	663.3	–	1.7	B71836E.TPA.P4
6000	9000	219	786	1669	662	2530	5681	117.6	200.0	284.1	–	1.7	HCB71836C.TPA.P4
5300	8000	274	1166	2586	799	3481	7901	269.6	454.4	617.5	–	1.7	HCB71836E.TPA.P4
4500	6700	966	3086	6300	2974	10221	22230	168.9	282.3	402.7	–	4.2	B71936C.T.P4S
4000	6000	1478	4921	10164	4320	14823	31493	403.5	633.6	849.1	–	4.2	B71936E.T.P4S
5600	8500	516	1708	3546	1565	5442	11841	148.5	241.1	335.1	–	3.5	HCB71936C.T.P4S
4800	7000	734	2644	5595	2150	7894	17065	357.4	565.8	752.2	–	3.5	HCB71936E.T.P4S
4000	6000	1513	4733	9600	4669	15697	33928	179.9	298.6	425.1	–	8.9	B7036C.T.P4S
3800	5600	2339	7529	15449	6843	22685	48042	430.4	668.0	894.5	–	8.9	B7036E.T.P4S
3800	5600	1906	5935	12015	5866	19581	42153	198.0	326.4	462.3	–	16.8	B7236C.T.P4S
3400	5000	2977	9503	19395	8706	28601	60002	477.2	737.1	981.7	–	16.8	B7236E.T.P4S
4500	6700	353	1299	2772	1074	4276	9771	130.0	230.5	336.7	–	2.2	B71838C.TPA.P4
4000	6000	429	1898	4254	1243	5671	13114	288.3	499.6	691.5	–	2.2	B71838E.TPA.P4
5600	8500	190	797	1764	571	2544	5959	115.1	205.9	296.8	–	2.2	HCB71838C.TPA.P4
4800	7000	181	1095	2626	526	3252	7985	242.2	458.8	640.0	–	2.2	HCB71838E.TPA.P4
4300	6300	894	2996	6210	2736	9846	21803	167.2	283.7	407.1	–	4.4	B71938C.T.P4S
3800	5600	1259	4576	9707	3666	13727	29966	390.1	630.2	851.6	–	4.4	B71938E.T.P4S
5300	8000	449	1619	3440	1353	5130	11428	144.0	240.8	337.0	–	3.6	HCB71938C.T.P4S
4500	6700	564	2402	5321	1650	7148	16175	334.3	559.2	754.7	–	3.6	HCB71938E.T.P4S
3800	5600	1445	4671	9575	4437	15414	33658	181.9	304.8	435.1	–	9.3	B7038C.T.P4S
3600	5300	2141	7290	15228	6260	21908	47088	430.9	680.6	915.2	–	9.3	B7038E.T.P4S
3400	5000	1860	5955	12166	5701	19571	42506	202.3	336.4	477.6	–	20.3	B7238C.T.P4S
3200	4800	2816	9424	19525	8217	28309	60271	484.1	759.4	1016.1	–	20.3	B7238E.T.P4S

SPINDLE BEARINGS

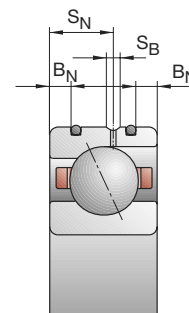
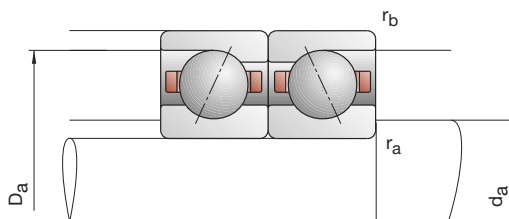
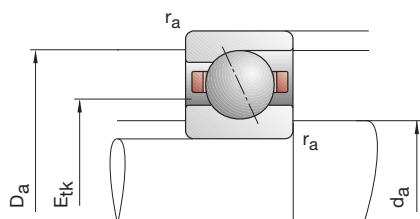

Bearing Code	Dimensions					Abutment Dimensions				DLR Dimensions			Load Ratings		
	d	D	B	r _{smin}	r _{1smin}	d _a h12	D _a H12	r _a max	r _b max	B _N	S _N	S _B	E _{tk}	C _{dyn}	C _{0stat}
FAG	mm													kN	
B71840C.TPA.P4	200	250	24	1.50	0.60	211	239	1.5	0.6				218.9	81.50	114.00
B71840E.TPA.P4	200	250	24	1.50	0.60	211	239	1.5	0.6				218.9	76.50	106.00
HCB71840C.TPA.P4	200	250	24	1.50	0.60	211	239	1.5	0.6				218.9	57.00	78.00
HCB71840E.TPA.P4	200	250	24	1.50	0.60	211	239	1.5	0.6				218.9	53.00	73.50
B71940C.T.P4S	200	280	38	2.10	1.10	214	266	1.0	1.0				232.4	204.00	255.00
B71940E.T.P4S	200	280	38	2.10	1.10	214	266	1.0	1.0				232.4	193.00	240.00
HCB71940C.T.P4S	200	280	38	2.10	1.10	214	266	1.0	1.0				232.4	140.00	176.00
HCB71940E.T.P4S	200	280	38	2.10	1.10	214	266	1.0	1.0				232.4	134.00	166.00
B7040C.T.P4S	200	310	51	2.10	2.10	217	293	2.0	1.0				241.5	305.00	390.00
B7040E.T.P4S	200	310	51	2.10	2.10	217	293	2.0	1.0				241.5	290.00	365.00
B7240C.T.P4S	200	360	58	4.00	4.00	238.5	321.5	3.0	3.0				268.6	325.00	440.00
B7240E.T.P4S	200	360	58	4.00	4.00	238.5	321.5	3.0	3.0				268.6	310.00	415.00
B71844C.TPA.P4	220	270	24	1.50	0.60	231	259	1.5	0.6				238.9	83.00	118.00
B71844E.TPA.P4	220	270	24	1.50	0.60	231	259	1.5	0.6				238.9	78.00	110.00
HCB71844C.TPA.P4	220	270	24	1.50	0.60	231	259	1.5	0.6				238.9	57.00	83.00
HCB71844E.TPA.P4	220	270	24	1.50	0.60	231	259	1.5	0.6				238.9	54.00	76.50
B71944C.T.P4S	220	300	38	2.10	1.10	234	286	1.0	1.0				252.4	216.00	285.00
B71944E.T.P4S	220	300	38	2.10	1.10	234	286	1.0	1.0				252.4	204.00	270.00
HCB71944C.T.P4S	220	300	38	2.10	1.10	234	286	1.0	1.0				252.4	150.00	200.00
HCB71944E.T.P4S	220	300	38	2.10	1.10	234	286	1.0	1.0				252.4	140.00	190.00
B7044C.T.P4S	220	340	56	3.00	3.00	239	321	2.5	1.0				266.5	325.00	440.00
B7044E.T.P4S	220	340	56	3.00	3.00	239	321	2.5	1.0				266.5	310.00	415.00
B7244C.T.P4S	220	400	65	4.00	4.00	264	356	3.0	3.0				296.2	400.00	560.00
B7244E.T.P4S	220	400	65	4.00	4.00	264	356	3.0	3.0				296.2	380.00	540.00

Designation examples:

Hybrid ceramic design

See Bearing Code, page 178

HCB71940C.T.P4S.UL

HCB71840C.TPA.P4.UL

SPINDLE BEARINGS

B718..C/E, B719, B70, B72 HS719..C/E, HS70

C: Contact Angle $\alpha = 15^\circ$ / E: Contact Angle $\alpha = 25^\circ$

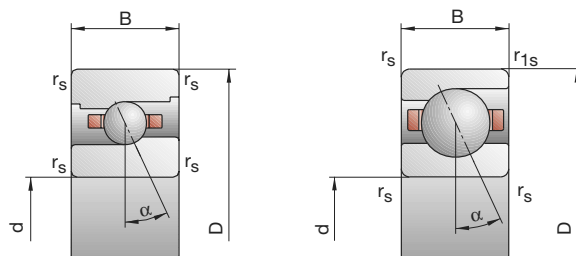

200
—
220

Attainable Speed		Preloading Force F_V			Unloading Force K_{aE}			Axial Rigidity S_a			Sealed Design	Weight kg	Bearing Code FAG
Grease min ⁻¹	Oil minimal	L	M	H	L	M	H	L	M	H			
4300	6300	355	1317	2817	1080	4320	9888	134.9	239.0	348.9	—	2.3	B71840C.TPA.P4
3800	5600	428	1920	4319	1239	5728	13287	298.8	519.7	719.4	—	2.3	B71840E.TPA.P4
5300	8000	191	806	1789	573	2565	6022	119.5	213.7	307.8	—	2.3	HCB71840C.TPA.P4
4500	6700	177	1103	2659	514	3273	8073	249.5	477.0	665.9	—	2.3	HCB71840E.TPA.P4
4000	6000	1133	3734	7704	3479	12312	27075	180.4	304.6	436.2	—	6.1	B71940C.T.P4S
3600	5300	1643	5803	12213	4794	17453	37826	424.3	679.6	916.6	—	6.1	B71940E.T.P4S
5000	7500	578	2027	4272	1747	6443	14237	156.1	258.7	361.2	—	5.1	HCB71940C.T.P4S
4300	6300	761	3056	6660	2225	9111	20237	367.3	603.1	808.9	—	5.1	HCB71940E.T.P4S
3600	5300	1805	5771	11787	5539	19000	41275	193.5	322.1	457.8	—	12.0	B7040C.T.P4S
3200	4800	2730	9122	18891	7970	27422	58373	462.5	725.5	971.1	—	12.0	B7040E.T.P4S
3200	4800	1916	6138	12545	5866	20139	43737	211.0	350.6	497.4	—	24.4	B7240C.T.P4S
3000	4500	2901	9725	20159	8461	29193	62166	505.7	793.3	1061.0	—	24.4	B7240E.T.P4S
3800	5600	358	1335	2861	1087	4366	10004	139.8	247.6	361.0	—	2.5	B71844C.TPA.P4
3400	5000	427	1943	4384	1235	5789	13463	309.1	539.7	747.1	—	2.5	B71844E.TPA.P4
4800	7000	191	815	1815	572	2587	6089	123.5	221.4	318.8	—	2.5	HCB71844C.TPA.P4
4000	6000	166	1081	2630	482	3202	7987	253.1	489.9	685.9	—	2.5	HCB71844E.TPA.P4
3600	5300	1191	3942	8140	3646	12940	28444	196.9	331.8	474.0	—	6.7	B71944C.T.P4S
3200	4800	1714	6084	12867	4995	18257	39642	463.3	741.8	999.9	—	6.7	B71944E.T.P4S
4500	6700	618	2176	4593	1861	6882	15259	171.7	284.2	396.9	—	5.6	HCB71944C.T.P4S
3800	5600	799	3255	7114	2334	9694	21583	402.2	663.1	889.5	—	5.6	HCB71944E.T.P4S
3200	4800	1916	6138	12545	5866	20139	43737	211.0	350.6	497.4	—	16.0	B7044C.T.P4S
3000	4500	2901	9725	20159	8461	29193	62166	505.7	793.3	1061.0	—	16.0	B7044E.T.P4S
2800	4300	2406	7621	15567	7360	24861	54043	225.4	371.1	525.7	—	33.6	B7244C.T.P4S
2600	4000	3670	12081	24979	10706	36160	76950	542.6	843.8	1127.0	—	33.6	B7244E.T.P4S

SPINDLE BEARINGS

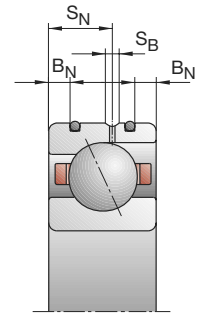
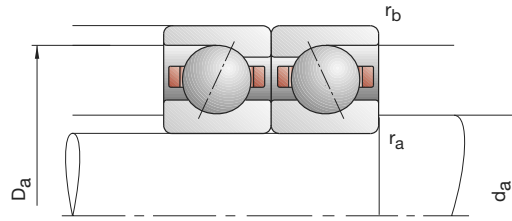
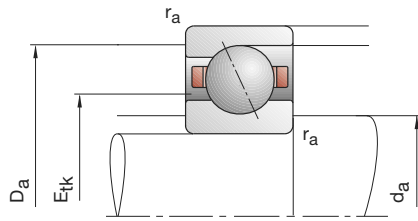

Bearing Code	Dimensions					Abutment Dimensions				DLR Dimensions			Load Ratings		
	d	D	B	r _{smin}	r _{1smin}	d _a h12	D _a H12	r _a max	r _b max	B _N	S _N	S _B	E _{tk}	C _{dyn}	C _{0stat}
FAG	mm													kN	
B71848C.TPA.P4	240	300	28	2.00	1.00	253	287	2.0	1.0				262.8	106.00	150.00
B71848E.TPA.P4	240	300	28	2.00	1.00	253	287	2.0	1.0				262.8	98.00	140.00
HCB71848C.TPA.P4	240	300	28	2.00	1.00	253	287	2.0	1.0				262.8	72.00	104.00
HCB71848E.TPA.P4	240	300	28	2.00	1.00	253	287	2.0	1.0				262.8	68.00	96.50
B71948C.T.P4S	240	320	38	2.10	1.10	254	307	1.0	1.0				272.4	224.00	310.00
B71948E.T.P4S	240	320	38	2.10	1.10	254	307	1.0	1.0				272.4	212.00	285.00
HCB71948C.T.P4S	240	320	38	2.10	1.10	254	307	1.0	1.0				272.4	153.00	216.00
HCB71948E.T.P4S	240	320	38	2.10	1.10	254	307	1.0	1.0				272.4	146.00	200.00
B7048C.T.P4S	240	360	56	3.00	3.00	260	341	2.5	1.0				286.5	335.00	465.00
B7048E.T.P4S	240	360	56	3.00	3.00	260	341	2.5	1.0				286.5	315.00	440.00
B71952C.T.P4S	260	360	46	2.10	1.10	278	342	1.0	1.0				300.5	285.00	415.00
B71952E.T.P4S	260	360	46	2.10	1.10	278	342	1.0	1.0				300.5	270.00	390.00
B71956C.T.P4S	280	380	46	2.10	1.10	298	362	1.0	1.0				320.5	300.00	450.00
B71956E.T.P4S	280	380	46	2.10	1.10	298	362	1.0	1.0				320.5	280.00	425.00
B71960C.T.P4S	300	420	56	3.00	1.10	322	398	1.5	1.0				348.6	360.00	570.00
B71960E.T.P4S	300	420	56	3.00	1.10	322	398	1.5	1.0				348.6	340.00	540.00
B71964C.T.P4S	320	440	56	3.00	1.10	342	418	1.5	1.0				368.6	375.00	620.00
B71964E.T.P4S	320	440	56	3.00	1.10	342	418	1.5	1.0				368.6	355.00	585.00
B71968C.T.P4S	340	460	56	3.00	1.10	362	438	1.5	1.0				388.6	380.00	640.00
B71968E.T.P4S	340	460	56	3.00	1.10	362	438	1.5	1.0				388.6	360.00	610.00
B71972C.T.P4S	360	480	56	3.00	1.10	382	458	1.5	1.0				408.6	390.00	695.00
B71972E.T.P4S	360	480	56	3.00	1.10	382	458	1.5	1.0				408.6	375.00	640.00
Designation examples: Hybrid ceramic design See Bearing Code, page 178															
HCB71948C.T.P4S.UL															
HCB71848C.TPA.P4.UL															

SPINDLE BEARINGS

B718..C/E, B719, B70, B72 HS719..C/E, HS70

C: Contact Angle $\alpha = 15^\circ$ / E: Contact Angle $\alpha = 25^\circ$

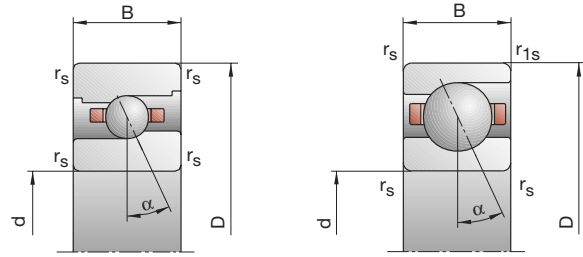

Attainable Speed	Grease	Oil minimal	Preloading Force F_V			Unloading Force K_{aE}			Axial Rigidity S_a			Sealed Design	Weight	Bearing Code
			L	M	H	L	M	H	L	M	H			
min ⁻¹			N						N/ μ m			kg	FAG	
3400	5000		493	1763	3743	1501	5795	13170	156.0	272.7	397.0	-	3.9	B71848C.TPA.P4
3000	4500		613	2571	5687	1773	7681	17504	348.3	592.4	814.5	-	3.9	B71848E.TPA.P4
4300	6300		271	1084	2370	813	3448	7964	139.0	243.9	349.0	-	3.9	HCB71848C.TPA.P4
3600	5300		282	1519	3561	819	4515	10824	301.7	549.2	759.1	-	3.9	HCB71848E.TPA.P4
3200	4800		1230	4079	8431	3759	13355	29363	207.8	349.8	499.1	-	7.2	B71948C.T.P4S
3000	4500		1768	6303	13347	5149	18893	41059	489.6	784.5	1057.1	-	7.2	B71948E.T.P4S
4000	6000		632	2237	4729	1900	7059	15665	180.7	299.2	417.4	-	6.0	HCB71948C.T.P4S
3600	5300		794	3280	7196	2318	9755	21789	419.8	694.6	932.0	-	6.0	HCB71948E.T.P4S
3000	4500		1971	6321	12923	6028	20706	44965	219.7	364.8	517.2	-	17.0	B7048C.T.P4S
2800	4300		2933	9860	20455	8547	29565	62978	523.7	821.7	1098.4	-	17.0	B7048E.T.P4S
3000	4500		1625	5291	10870	4955	17278	37700	222.8	371.5	527.4	-	12.1	B71952C.T.P4S
2600	4000		2393	8255	17265	6977	24698	53045	530.5	838.7	1124.2	-	12.1	B71952E.T.P4S
2600	4000		1706	5562	11434	5196	18131	39565	237.5	395.6	561.2	-	12.9	B71956C.T.P4S
2400	3800		2463	8534	17870	7176	25504	54810	562.2	889.2	1191.1	-	12.9	B71956E.T.P4S
2400	3800		2097	6764	13849	6380	21926	47710	249.9	412.9	583.7	-	20.4	B71960C.T.P4S
2200	3600		3116	10570	21984	9061	31517	67389	598.5	938.7	1254.1	-	20.4	B71960E.T.P4S
2200	3600		2177	7017	14413	6612	22683	49487	265.7	437.8	618.7	-	21.6	B71964C.T.P4S
2000	3400		3235	11010	22920	9401	32795	70159	637.3	999.9	1335.1	-	21.6	B71964E.T.P4S
2200	3600		2061	6876	14282	6235	22142	48709	265.6	442.4	626.4	-	22.7	B71968C.T.P4S
1900	3200		2930	10616	22515	8516	31562	68780	630.3	1008.6	1354.6	-	22.7	B71968E.T.P4S
2000	3400		2101	7037	14635	6343	22593	49716	279.0	464.3	656.5	-	23.9	B71972C.T.P4S
1800	3000		3030	11025	23411	8803	32751	71437	666.9	1068.0	1434.0	-	23.9	B71972E.T.P4S

FLOATING DISPLACEMENT BEARINGS



The floating bearing function in spindles is a well-known problem. While simple solutions represent a compromise between costs and function, demanding solutions offer enhanced functional reliability but involve significantly higher costs at the same time. FAG developed FD bearings especially for application as floating bearings in motor spindles. FD bearings con-

sist of a deep groove ball bearing outer ring and a cylindrical roller bearing inner ring. This combination ensures a free displacement of the outer relative to the inner ring during operation. Considered in detail, this solution is extremely sophisticated. For this reason the latest findings in rolling bearing technology were applied in the design of FAG FD bearings. Ceramic balls

and Cronidur 30 high-performance steel ensure a contact between inner ring and ball appropriate for the demand. Sufficient load carrying capacity coupled with extremely high speed-ability opens up new design opportunities for the floating bearing location. A special bearing clearance was determined by simulating the application which, in combination with a cus-

tom-adjusted fit, offers optimum operating conditions.

FAG FD bearings exhibit the same external dimensions as spindle bearings of series B70 or cylindrical roller bearings of series N10. Thus they are familiar to the designer and can be easily integrated into existing designs.

FAG FD bearings are also available in a sealed version (suffix .2RSD) Sealed bearings are filled „for life“ with FAG Arcanol L75 high performance grease.

To facilitate accurate adjustment of internal radial clearance FD bearings featuring a tapered inner ring bore are available (suffix K.)



6: FD bearings permit a sure and free displacement between inner and outer ring

FLOATING DISPLACEMENT BEARINGS

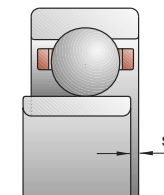
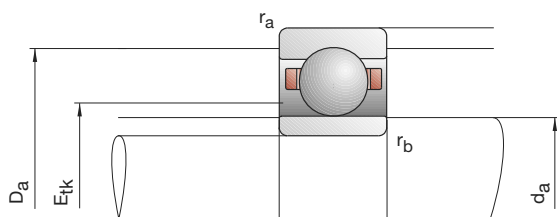

Bearing Code	Dimensions						Abutment Dimensions				
	d	D	B	r _{smin}	r _{1smin}	s	d _a h12	D _a H12	r _a max	r _b max	E _{tk}
FAG	mm										
FD1000T.P4S	10	26	8	0.30	0.30	1.2	13.5	22.0	0.3	0.3	15.3
FD1001T.P4S	12	28	8	0.30	0.30	1.2	16.0	24.5	0.3	0.3	17.5
FD1002T.P4S	15	32	9	0.30	0.30	1.7	18.0	29.0	0.3	0.3	20.2
FD1003T.P4S	17	35	10	0.30	0.30	2.0	20.0	32.0	0.3	0.3	22.2
FD1004T.P4S	20	42	12	0.60	0.30	2.3	24.0	37.0	0.6	0.3	26.6
FD1005T.P4S	25	47	12	0.60	0.30	2.5	28.0	42.5	0.6	0.3	31.1
FD1006T.P4S	30	55	13	1.00	0.60	2.6	35.0	50.0	1.0	0.6	38.0
FD1007T.P4S	35	62	14	1.00	0.60	2.7	40.0	56.5	1.0	0.6	43.0
FD1008T.P4S	40	68	15	1.00	0.60	2.7	45.0	62.0	1.0	0.6	48.5
FD1009T.P4S	45	75	16	1.00	0.60	3.2	50.0	69.0	1.0	0.6	53.4
FD1010T.P4S	50	80	16	1.00	0.60	3.2	55.0	74.5	1.0	0.6	58.4
FD1011T.P4S	55	90	18	1.10	1.00	3.8	60.0	84.0	1.1	1.0	64.8
FD1012T.P4S	60	95	18	1.10	1.00	3.8	65.0	89.0	1.1	1.0	69.8
FD1013T.P4S	65	100	18	1.10	1.00	3.8	70.0	94.0	1.1	1.0	74.8
FD1014T.P4S	70	110	20	1.10	1.00	4.3	76.0	103.0	1.1	1.0	81.2
FD1015T.P4S	75	115	20	1.10	1.00	4.3	81.0	108.0	1.1	1.0	86.2
FD1016T.P4S	80	125	22	1.10	1.00	4.8	87.0	117.0	1.1	1.0	92.6
FD1017T.P4S	85	130	22	1.10	1.00	4.8	92.0	122.0	1.1	1.0	97.6
FD1018T.P4S	90	140	24	1.50	1.10	5.4	98.0	131.0	1.5	1.1	104.0
Designation example: FD1010T.P4S						See Bearing Code, page 182					

FLOATING DISPLACEMENT BEARINGS

FD10

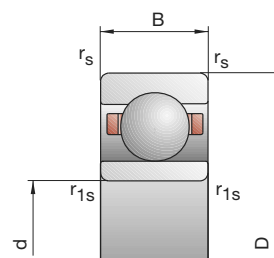

Load Ratings		Attainable Speed Grease	Oil minimal	Weight kg	Bearing Code
C _{dyn} kN	C _{0stat}				
1.86	0.14	100000	170000	0.02	FD1000T.P4S
2.12	0.17	90000	150000	0.02	FD1001T.P4S
2.80	0.22	75000	120000	0.03	FD1002T.P4S
3.90	0.33	70000	110000	0.04	FD1003T.P4S
4.65	0.40	60000	90000	0.07	FD1004T.P4S
6.55	0.60	50000	75000	0.07	FD1005T.P4S
6.80	0.67	43000	63000	0.11	FD1006T.P4S
8.65	0.90	36000	53000	0.15	FD1007T.P4S
9.50	1.02	34000	50000	0.18	FD1008T.P4S
12.50	1.37	30000	45000	0.22	FD1009T.P4S
12.90	1.50	28000	43000	0.24	FD1010T.P4S
17.60	2.00	24000	38000	0.35	FD1011T.P4S
18.00	2.16	24000	38000	0.38	FD1012T.P4S
18.60	2.28	22000	36000	0.40	FD1013T.P4S
22.40	2.80	20000	34000	0.55	FD1014T.P4S
23.60	3.00	19000	32000	0.58	FD1015T.P4S
29.00	3.75	17000	28000	0.78	FD1016T.P4S
30.00	4.00	16000	26000	0.82	FD1017T.P4S
35.50	4.65	15000	24000	1.07	FD1018T.P4S



10
90

FLOATING DISPLACEMENT BEARINGS

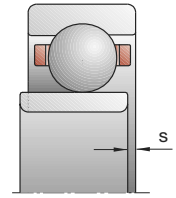
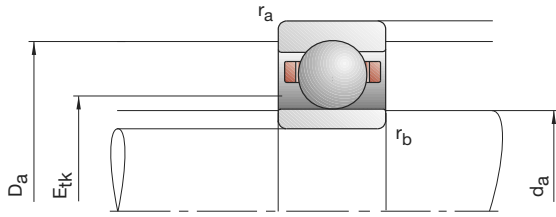

Bearing Code	Dimensions						Abutment Dimensions				
	d	D	B	r _{smin}	r _{1smin}	s	d _a h12	D _a H12	r _a max	r _b max	E _{tk}
FAG	mm										
FD1019T.P4S	95	145	24	1.50	1.10	5.4	103.0	136.0	1.5	1.1	109.0
FD1020T.P4S	100	150	24	1.50	1.10	5.4	108.0	141.0	1.5	1.1	114.0
FD1021T.P4S	105	160	26	2.00	1.10	6.5	112.0	152.0	2.0	1.1	119.4
FD1022T.P4S	110	170	28	2.00	1.10	6.5	120.0	159.0	2.0	1.1	126.9
FD1024T.P4S	120	180	28	2.00	1.10	6.5	130.0	169.0	2.0	1.1	136.9
FD1026T.P4S	130	200	33	2.00	1.10	7.5	141.0	187.0	2.0	1.1	149.7
FD1028T.P4S	140	210	33	2.00	1.10	7.5	151.0	198.0	2.0	1.1	159.7
FD1030T.P4S	150	225	35	2.10	1.50	8.6	161.0	213.0	2.1	1.5	170.0
FD1032T.P4S	160	240	38	2.10	1.50	8.6	173.0	226.0	2.1	1.5	182.5
Designation example: FD1010T.P4S						See Bearing Code, page 182					

FLOATING DISPLACEMENT BEARINGS

FD10

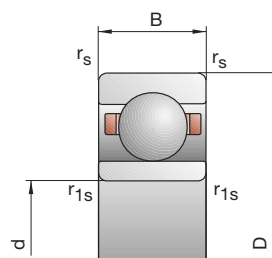

Load Ratings		Attainable Speed Grease	Oil minimal	Weight kg	Bearing Code
C _{dyn} kN	C _{0stat}				
36.50	4.90	14000	22000	1.11	FD1019T.P4S
38.00	5.20	14000	22000	1.16	FD1020T.P4S
49.00	6.70	13000	20000	1.42	FD1021T.P4S
51.00	7.10	12000	19000	1.83	FD1022T.P4S
52.00	7.50	11000	18000	1.95	FD1024T.P4S
67.00	9.65	10000	17000	2.96	FD1026T.P4S
69.50	10.20	9000	15000	3.13	FD1028T.P4S
85.00	12.50	8500	14000	3.69	FD1030T.P4S
86.50	13.40	8000	13000	4.70	FD1032T.P4S



95
160

SUPER PRECISION CYLINDRICAL ROLLER BEARINGS



Radial cylindrical roller bearings in high-precision design are an integral part of the FAG super precision range. Series N10 and NN30 are entirely available in this design, while there are some selected bearing sizes of series N19 and NNU49.

They are ideal floating bearings as the linear expansion during rotation is accommodated between rollers and raceways. Moreover, radial cylindrical roller bearings distinguish themselves by their high radial rigidity.

In addition to their application as floating bearings where single row bearings are used almost exclusively, they are chosen for bearing arrangements that call for

- radial rigidity
- high load carrying capacity
- and high precision.

The axial loads in such applications are usually accommodated by double direction angular contact thrust ball bearings of series 2344 (see page 102).

Bearing Design

Standard cylindrical roller bearings feature a tapered bore (taper 1:12) for precise adjustment of the radial clearance. Thus the desired radial clearance or radial preload can be adjusted by axial displacement on the tapered shaft. Hybrid cylindrical roller bearings with rollers from ceramic material have been newly included in the product range. Thanks to the use of ceramic rollers, they offer significantly improved characteristics in terms of bearing friction and wear.

This reduces the demand on the lubricant and leads to lower temperatures. Consequently, higher speeds are permissible and the service life is extended to a significant degree. Furthermore, ceramic rollers lead to increased static and dynamic rigidity and their lower thermal expansion coefficient defuses an increase in preload at elevated temperatures.

Thanks to the high surface quality of ring raceways and rollers, FAG cylindrical roller bearings are particularly suitable for grease lubrication. The grease distribution run has to be carried out especially carefully since they comprise lips at one ring.

In the case of oil lubrication, attention has to be paid to their lower oil requirement in comparison with angular contact ball bearings. The oil circuits have to be kept separate if these two bearing types are mounted side by side. Excess lubrication due to oil flow from the angular contact ball bearings has to be avoided as a sharp increase in bearing temperatures is to be expected otherwise.

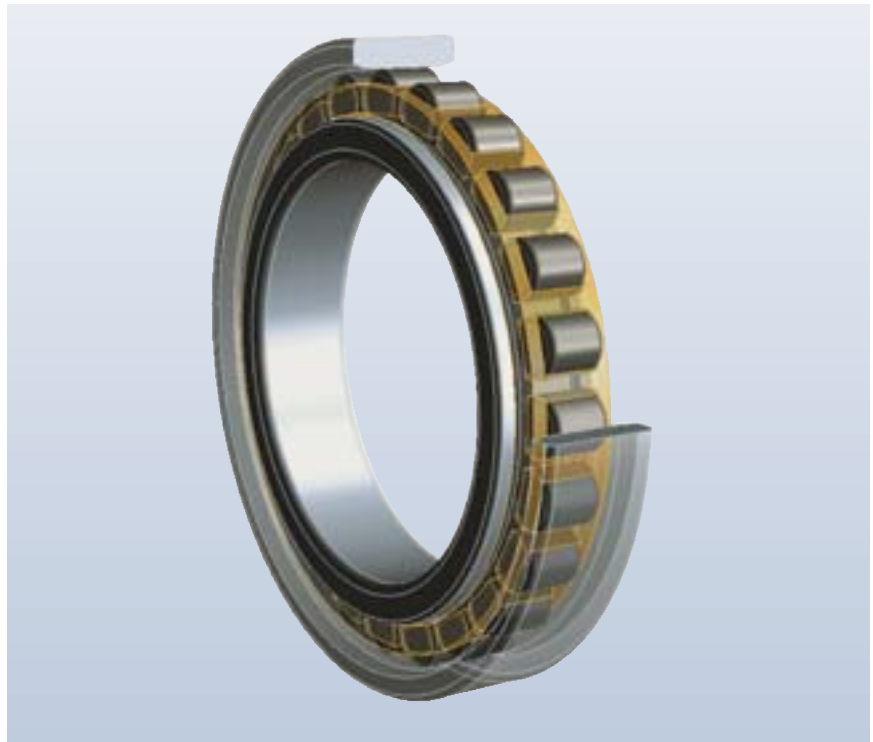

7: Hybrid cylindrical roller bearings HCN..

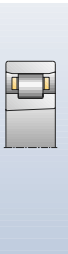

SUPER PRECISION CYLINDRICAL ROLLER BEARINGS

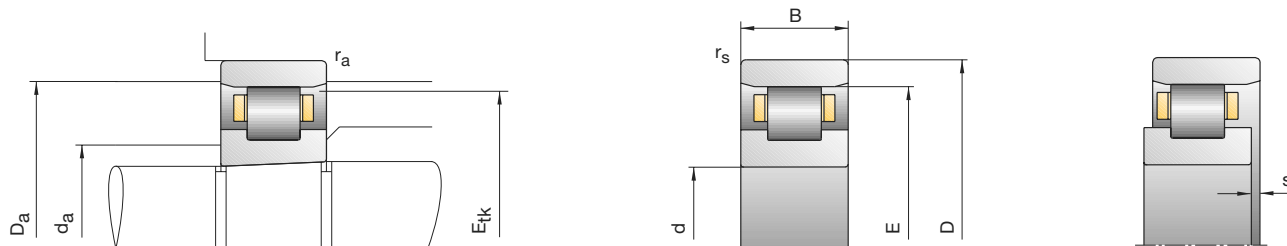

Bearing Code	Dimensions						Abutment Dimensions			
	d	D	B	r_{smin}	E	s	d_a h12	D_a H12	r_a max	E_{tk}
FAG	mm									
N1006K.M1.SP	30	55	13	0.60	48.5	1.9	36.5	49	0.60	47.0
HCN1006K.M1.SP	30	55	13	0.60	48.5	1.9	36.5	49	0.60	47.0
N1007K.M1.SP	35	62	14	0.60	55.0	2.0	42.0	56	0.60	53.4
HCN1007K.M1.SP	35	62	14	0.60	55.0	2.0	42.0	56	0.60	53.4
N1008K.M1.SP	40	68	15	0.60	61.0	2.1	47.0	62	0.60	59.3
HCN1008K.M1.SP	40	68	15	0.60	61.0	2.1	47.0	62	0.60	59.3
N1009K.M1.SP	45	75	16	0.60	67.5	2.2	52.5	69	0.60	65.6
HCN1009K.M1.SP	45	75	16	0.60	67.5	2.2	52.5	69	0.60	65.6
N1910K.M1.SP	50	72	12	0.60	66.5	1.8	55.5	67	0.60	65.1
N1010K.M1.SP	50	80	16	0.60	72.5	2.2	57.5	74	0.60	70.6
HCN1010K.M1.SP	50	80	16	0.60	72.5	2.2	57.5	74	0.60	70.6
N1911K.M1.SP	55	80	13	1.00	73.5	1.9	61.5	74	1.00	72.0
N1011K.M1.SP	55	90	18	1.00	80.5	2.5	64.5	82	1.00	78.5
HCN1011K.M1.SP	55	90	18	1.00	80.5	2.5	64.5	82	1.00	78.5
N1912K.M1.SP	60	85	13	1.00	78.5	1.9	66.5	79	1.00	77.0
N1012K.M1.SP	60	95	18	1.00	85.5	2.5	69.5	87	1.00	83.5
HCN1012K.M1.SP	60	95	18	1.00	85.5	2.5	69.5	87	1.00	83.5
N1913K.M1.SP	65	90	13	1.00	83.5	1.9	71.5	84	1.00	82.0
N1013K.M1.SP	65	100	18	1.00	90.5	2.5	74.5	92	1.00	88.5
HCN1013K.M1.SP	65	100	18	1.00	90.5	2.5	74.5	92	1.00	88.5
N1914K.M1.SP	70	100	16	1.00	92.0	2.3	78.0	93	1.00	90.3
N1014K.M1.SP	70	110	20	1.00	100.0	2.5	80.0	101	1.00	97.5
HCN1014K.M1.SP	70	110	20	1.00	100.0	2.5	80.0	101	1.00	97.5
N1915K.M1.SP	75	105	16	1.00	97.0	2.3	83.0	98	1.00	95.3
N1015K.M1.SP	75	115	20	1.00	105.0	2.5	85.0	106	1.00	102.5
HCN1015K.M1.SP	75	115	20	1.00	105.0	2.5	85.0	106	1.00	102.5
Designation examples:		Standard design				Cylindrical bore				
		N1014K.M1.SP				N1014M1.SP				
		N1914K.M1.SP				N1914M1.SP				

SUPER PRECISION CYLINDRICAL ROLLER BEARINGS

N10, N19, HCN10

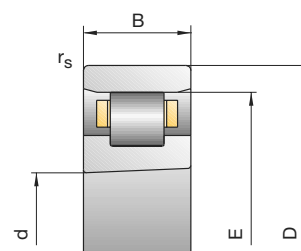

Load Ratings		Attainable Speed		Radial Stiffness	Weight	Bearing Code
C _{dyn}	C _{0stat}	Grease	Oil minimal	C _s		FAG
kN		min ⁻¹		N/μm	kg	
20.40	20.40	19000	22000	370	0.13	N1006K.M1.SP
16.00	17.00	24000	28000	450	0.13	HCN1006K.M1.SP
23.60	24.50	16000	18000	410	0.17	N1007K.M1.SP
19.00	20.40	20000	24000	490	0.17	HCN1007K.M1.SP
27.50	29.00	15000	17000	440	0.22	N1008K.M1.SP
21.60	24.50	20000	24000	530	0.21	HCN1008K.M1.SP
34.50	39.00	13000	15000	550	0.27	N1009K.M1.SP
28.00	33.50	17000	19000	670	0.27	HCN1009K.M1.SP
22.40	27.50	13000	15000	530	0.15	N1910K.M1.SP
36.00	41.50	12000	14000	580	0.30	N1010K.M1.SP
28.50	34.50	16000	18000	700	0.30	HCN1010K.M1.SP
25.00	31.50	12000	14000	540	0.21	N1911K.M1.SP
41.50	50.00	11000	13000	650	0.44	N1011K.M1.SP
33.50	42.50	14000	16000	780	0.44	HCN1011K.M1.SP
26.00	34.00	11000	13000	580	0.22	N1912K.M1.SP
44.00	55.00	10000	12000	710	0.47	N1012K.M1.SP
35.50	46.50	13000	15000	850	0.47	HCN1012K.M1.SP
29.00	40.00	10000	12000	680	0.24	N1913K.M1.SP
45.00	58.50	9500	11000	730	0.50	N1013K.M1.SP
36.00	48.00	12000	14000	890	0.50	HCN1013K.M1.SP
36.50	49.00	9500	11000	710	0.38	N1914K.M1.SP
64.00	81.50	9000	10000	820	0.69	N1014K.M1.SP
52.00	68.00	12000	14000	990	0.69	HCN1014K.M1.SP
38.00	53.00	9000	10000	760	0.41	N1915K.M1.SP
65.50	85.00	8500	9500	850	0.73	N1015K.M1.SP
53.00	71.00	11000	13000	1030	0.72	HCN1015K.M1.SP

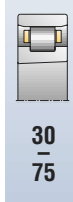

Hybrid design
HCN1014K.M1.SP

See Bearing Code, page 186

SUPER PRECISION CYLINDRICAL ROLLER BEARINGS

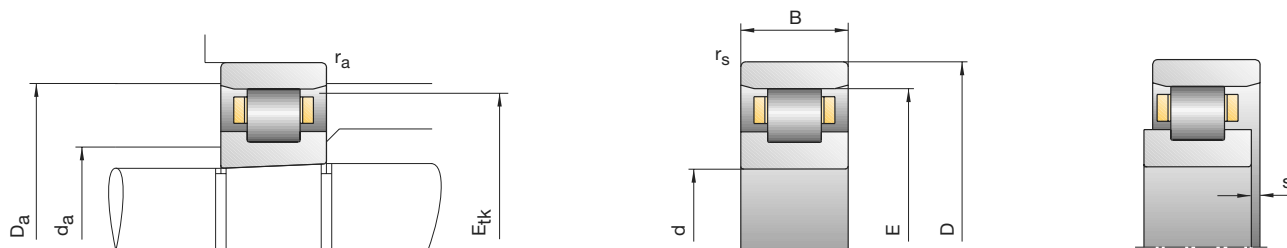

Bearing Code	Dimensions						Abutment Dimensions			
	d	D	B	r_{smin}	E	s	d_a h12	D_a H12	r_a max	E_{tk}
FAG	mm									
N1916K.M1.SP	80	110	16	1.00	102.0	2.3	88.0	103	1.00	100.3
N1016K.M1.SP	80	125	22	1.00	113.5	3.0	91.5	115	1.00	110.8
HCN1016K.M1.SP	80	125	22	1.00	113.5	3.0	91.5	115	1.00	110.8
N1917K.M1.SP	85	120	18	1.00	110.5	2.5	94.5	112	1.00	108.5
N1017K.M1.SP	85	130	22	1.00	118.5	3.0	96.5	120	1.00	115.8
HCN1017K.M1.SP	85	130	22	1.00	118.5	3.0	96.5	120	1.00	115.8
N1918K.M1.SP	90	125	18	1.00	115.5	2.5	99.5	117	1.00	113.5
N1018K.M1.SP	90	140	24	1.10	127.0	3.2	103.0	129	1.10	124.0
HCN1018K.M1.SP	90	140	24	1.10	127.0	3.2	103.0	129	1.10	124.0
N1919K.M1.SP	95	130	18	1.00	120.5	2.5	104.5	122	1.00	118.5
N1019K.M1.SP	95	145	24	1.10	132.0	3.2	108.0	134	1.10	129.0
HCN1019K.M1.SP	95	145	24	1.10	132.0	3.2	108.0	134	1.10	129.0
N1920K.M1.SP	100	140	20	1.00	130.0	2.5	110.0	132	1.00	127.5
N1020K.M1.SP	100	150	24	1.10	137.0	3.2	113.0	139	1.10	134.0
HCN1020K.M1.SP	100	150	24	1.10	137.0	3.2	113.0	139	1.10	134.0
N1921K.M1.SP	105	145	20	1.00	135.0	2.5	115.0	137	1.00	132.5
N1021K.M1.SP	105	160	26	1.10	145.5	3.4	119.5	147	1.10	142.3
HCN1021K.M1.SP	105	160	26	1.10	145.5	3.4	119.5	147	1.10	142.3
N1922K.M1.SP	110	150	20	1.00	140.0	2.5	120.0	142	1.00	137.5
N1022K.M1.SP	110	170	28	1.10	155.0	3.4	125.0	157	1.10	151.3
HCN1022K.M1.SP	110	170	28	1.10	155.0	3.4	125.0	157	1.10	151.3
N1924K.M1.SP	120	165	22	1.00	153.5	3.0	131.5	156	1.00	150.8
N1024K.M1.SP	120	180	28	1.10	165.0	3.4	135.0	167	1.10	161.3
HCN1024K.M1.SP	120	180	28	1.10	165.0	3.4	135.0	167	1.10	161.3
N1926K.M1.SP	130	180	24	1.10	167.0	3.2	143.0	170	1.10	164.0
N1026K.M1.SP	130	200	33	1.10	182.0	4.2	148.0	184	1.10	177.8
Designation examples:			Standard design				Cylindrical bore			
			N1014K.M1.SP				N1014M1.SP			
			N1914K.M1.SP				N1914M1.SP			

SUPER PRECISION CYLINDRICAL ROLLER BEARINGS

N10, N19, HCN10

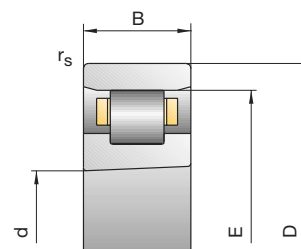

Load Ratings		Attainable Speed		Radial Stiffness	Weight	Bearing Code
C _{dyn}	C _{0stat}	Grease	Oil minimal	C _s	kg	FAG
kN		min ⁻¹		N/μm		
39.00	56.00	8500	9500	810	0.43	N1916K.M1.SP
76.50	98.00	7500	8500	900	0.99	N1016K.M1.SP
61.00	83.00	10000	12000	1080	0.98	HCN1016K.M1.SP
50.00	71.00	7500	8500	880	0.61	N1917K.M1.SP
78.00	104.00	7500	8500	940	1.04	N1017K.M1.SP
63.00	86.50	10000	12000	1130	1.04	HCN1017K.M1.SP
51.00	75.00	7500	8500	930	0.64	N1918K.M1.SP
93.00	125.00	6700	7500	1030	1.34	N1018K.M1.SP
75.00	104.00	8500	9500	1240	1.33	HCN1018K.M1.SP
52.00	78.00	7000	8000	960	0.67	N1919K.M1.SP
96.50	129.00	6300	7000	1070	1.40	N1019K.M1.SP
76.50	108.00	8000	9000	1290	1.39	HCN1019K.M1.SP
78.00	112.00	6300	7000	1100	0.92	N1920K.M1.SP
98.00	134.00	6000	6700	1110	1.46	N1020K.M1.SP
78.00	114.00	8000	9000	1340	1.45	HCN1020K.M1.SP
78.00	116.00	6000	6700	1140	0.96	N1921K.M1.SP
112.00	153.00	5600	6300	1160	1.82	N1021K.M1.SP
88.00	129.00	7500	8500	1400	1.81	HCN1021K.M1.SP
80.00	120.00	6000	6700	1170	0.99	N1922K.M1.SP
140.00	190.00	5300	6000	1240	2.30	N1022K.M1.SP
112.00	160.00	7000	8000	1500	2.29	HCN1022K.M1.SP
95.00	143.00	5300	6000	1270	1.36	N1924K.M1.SP
150.00	208.00	5000	5600	1340	2.47	N1024K.M1.SP
118.00	176.00	6700	7500	1620	2.46	HCN1024K.M1.SP
110.00	170.00	4800	5300	1350	1.80	N1926K.M1.SP
180.00	250.00	4300	4800	1420	3.72	N1026K.M1.SP

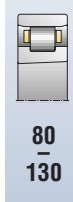

Hybrid design
HCN1014K.M1.SP

See Bearing Code, page 186

SUPER PRECISION CYLINDRICAL ROLLER BEARINGS

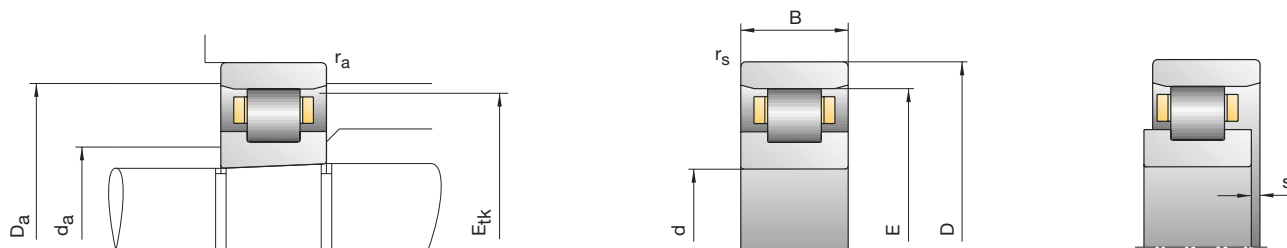

Bearing Code	Dimensions						Abutment Dimensions			
	d	D	B	r_{smin}	E	s	d_a h12	D_a H12	r_a max	E_{tk}
FAG	mm									
N1928K.M1.SP	140	190	24	1.10	177.0	3.2	153.0	180	1.10	174.0
N1028K.M1.SP	140	210	33	1.10	192.0	4.2	158.0	194	1.10	187.8
N1930K.M1.SP	150	210	28	1.10	194.0	3.6	166.0	197	1.10	190.5
N1030K.M1.SP	150	225	35	1.50	205.5	4.4	169.5	208	1.50	201.0
N1932K.M1.SP	160	220	28	1.10	204.0	3.6	176.0	206	1.10	200.5
N1032K.M1.SP	160	240	38	1.50	220.0	4.6	180.0	222	1.50	215.0
N1934K.M1.SP	170	230	28	1.10	214.0	3.6	186.0	216	1.10	210.5
N1034K.M1.SP	170	260	42	2.10	237.0	5.0	193.0	240	2.10	231.5
N1936K.M1.SP	180	250	33	1.10	232.0	4.2	198.0	234	1.10	227.8
N1036K.M1.SP	180	280	46	2.10	255.0	5.6	205.0	258	2.10	248.8
N1938K.M1.SP	190	260	33	1.10	242.0	4.2	208.0	244	1.10	237.8
N1038K.M1.SP	190	290	46	2.10	265.0	5.6	215.0	268	2.10	258.8
N1940K.M1.SP	200	280	38	1.50	259.0	4.8	221.0	261	1.50	254.3
N1040K.M1.SP	200	310	51	2.10	281.0	6.4	229.0	284	2.10	274.5
N1944K.M1.SP	220	300	38	1.50	279.0	4.8	241.0	281	1.50	274.3
N1044K.M1.SP	220	340	56	3.00	310.0	6.6	250.0	313	3.00	302.5
N1948K.M1.SP	240	320	38	1.50	299.0	4.8	261.0	301	1.50	294.3
N1048K.M1.SP	240	360	56	3.00	330.0	6.6	270.0	333	3.00	322.5
N1952K.M1.SP	260	360	46	1.50	334.0	5.4	286.0	336	1.50	328.0
N1052K.M1.SP	260	400	65	4.00	364.0	8.1	296.0	368	4.00	355.5
N1956K.M1.SP	280	380	46	1.50	354.0	5.4	306.0	356	1.50	348.0
N1056K.M1.SP	280	420	65	4.00	384.0	8.1	316.0	388	4.00	375.5
N1960K.M1.SP	300	420	56	3.00	390.0	6.6	330.0	392	3.00	382.5
N1060K.M1.SP	300	460	74	4.00	420.0	8.7	340.0	425	4.00	410.0
Designation examples:		Standard design				Cylindrical bore				
		N1014K.M1.SP				N1014M1.SP				
		N1914K.M1.SP				N1914M1.SP				

SUPER PRECISION CYLINDRICAL ROLLER BEARINGS

N10, N19, HCN10

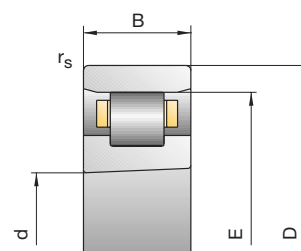

Load Ratings		Attainable Speed Grease	Oil minimal	Radial Stiffness C_s	Weight	Bearing Code
C_{dyn}	C_{0stat}					
kN		min^{-1}		$N/\mu m$	kg	FAG
116.00	186.00	4300	4800	1480	1.92	N1928K.M1.SP
183.00	265.00	4000	4500	1480	3.94	N1028K.M1.SP
150.00	236.00	4000	4500	1590	2.95	N1930K.M1.SP
208.00	310.00	3800	4300	1630	4.75	N1030K.M1.SP
153.00	250.00	3800	4300	1690	3.10	N1932K.M1.SP
245.00	355.00	3400	3800	1680	5.79	N1032K.M1.SP
160.00	265.00	3400	3800	1780	3.26	N1934K.M1.SP
300.00	430.00	3200	3600	1860	7.77	N1034K.M1.SP
208.00	335.00	3200	3600	1880	4.81	N1936K.M1.SP
360.00	520.00	3000	3400	1960	10.20	N1036K.M1.SP
220.00	365.00	3000	3400	1990	5.05	N1938K.M1.SP
365.00	550.00	2800	3200	2040	10.60	N1038K.M1.SP
265.00	430.00	2800	3200	2110	7.07	N1940K.M1.SP
400.00	600.00	2600	3000	2130	14.00	N1040K.M1.SP
265.00	450.00	2600	3000	2170	7.64	N1944K.M1.SP
510.00	765.00	2400	2800	2360	17.90	N1044K.M1.SP
285.00	500.00	2400	2800	2430	8.24	N1948K.M1.SP
540.00	850.00	2200	2600	2560	19.30	N1048K.M1.SP
430.00	750.00	2000	2400	2840	14.00	N1952K.M1.SP
655.00	1020.00	1900	2200	2710	28.60	N1052K.M1.SP
440.00	800.00	1900	2200	3000	14.90	N1956K.M1.SP
680.00	1100.00	1800	2000	2930	30.90	N1056K.M1.SP
610.00	1060.00	1700	1900	3150	23.60	N1960K.M1.SP
900.00	1430.00	1600	1800	3200	43.70	N1060K.M1.SP
Hybrid design		See Bearing Code, page 186				
HCN1014K.M1.SP						



140
300

SUPER PRECISION CYLINDRICAL ROLLER BEARINGS

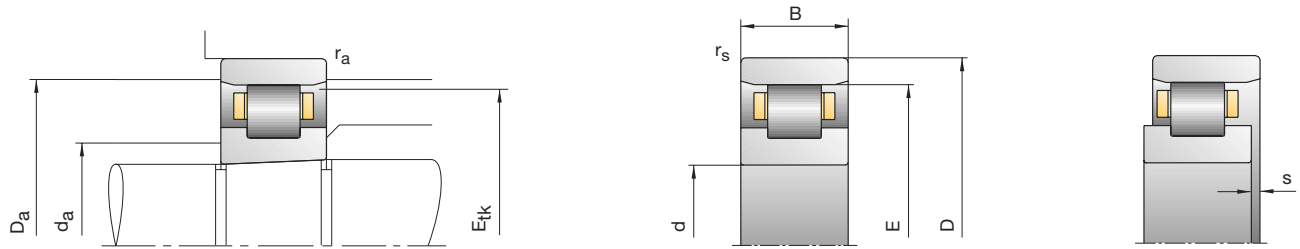

Bearing Code	Dimensions						Abutment Dimensions			
	d	D	B	r_{smin}	E	s	d_a h12	D_a H12	r_a max	E_{tk}
FAG	mm									
N1964K.M1.SP	320	440	56	3.00	410.0	6.6	350.0	412	3.00	402.5
N1064K.M1.SP	320	480	74	4.00	440.0	8.7	360.0	445	4.00	430.0
N1968K.M1.SP	340	460	56	3.00	430.0	6.6	370.0	433	3.00	422.5
N1068K.M1.SP	340	520	82	5.00	475.0	9.3	385.0	480	5.00	463.8
N1972K.M1.SP	360	480	56	3.00	450.0	6.6	390.0	453	3.00	442.5
N1072K.M1.SP	360	540	82	5.00	495.0	9.3	405.0	500	5.00	483.8
N1976K.M1.SP	380	520	65	4.00	484.0	8.1	416.0	487	4.00	475.5
N1076K.M1.SP	380	560	82	5.00	515.0	9.3	425.0	520	5.00	503.8
N1980K.M1.SP	400	540	65	4.00	504.0	8.1	436.0	507	4.00	495.5
N1080K.M1.SP	400	600	90	5.00	550.0	10.4	450.0	555	5.00	537.5
N1984K.M1.SP	420	560	65	4.00	524.0	8.1	456.0	527	4.00	515.5
N1084K.M1.SP	420	620	90	5.00	570.0	10.4	470.0	575	5.00	557.5
N1988K.M1.SP	440	600	74	4.00	558.0	9.1	482.0	562	4.00	548.5
N1088K.M1.SP	440	650	94	6.00	597.0	10.8	493.0	603	6.00	584.0
N1992K.M1.SP	460	620	74	4.00	578.0	9.1	502.0	582	4.00	568.5
N1092K.M1.SP	460	680	100	6.00	624.0	11.6	516.0	630	6.00	610.5
N1996K.M1.SP	480	650	78	5.00	605.0	9.5	525.0	609	5.00	595.0
N1096K.M1.SP	480	700	100	6.00	644.0	11.6	536.0	650	6.00	630.5
N19/500K.M1.SP	500	670	78	5.00	625.0	9.5	545.0	629	5.00	615.0
N10/500K.M1.SP	500	720	100	6.00	664.0	11.6	556.0	670	6.00	650.5
Designation examples:		Standard design				Cylindrical bore				
		N1014K.M1.SP				N1014M1.SP				
		N1914K.M1.SP				N1914M1.SP				

SUPER PRECISION CYLINDRICAL ROLLER BEARINGS

N10, N19, HCN10

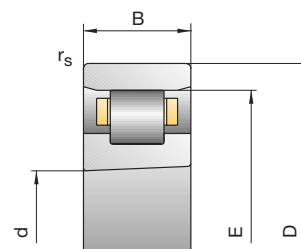

Load Ratings		Attainable Speed Grease	Oil minimal	Radial Stiffness C_s	Weight	Bearing Code
C_{dyn}	C_{0stat}					
kN		min^{-1}		$N/\mu m$	kg	FAG
620.00	1100.00	1600	1800	3250	24.90	N1964K.M1.SP
915.00	1500.00	1500	1700	3330	45.10	N1064K.M1.SP
655.00	1200.00	1500	1700	3550	26.30	N1968K.M1.SP
1120.00	1830.00	1400	1600	3610	60.70	N1068K.M1.SP
655.00	1220.00	1400	1600	3640	27.50	N1972K.M1.SP
1140.00	1900.00	1300	1500	3750	64.40	N1072K.M1.SP
815.00	1500.00	1300	1500	3900	40.00	N1976K.M1.SP
1180.00	2000.00	1300	1500	3900	66.60	N1076K.M1.SP
815.00	1560.00	1300	1500	4010	41.70	N1980K.M1.SP
1370.00	2320.00	1200	1400	4090	88.10	N1080K.M1.SP
850.00	1630.00	1200	1400	4230	43.50	N1984K.M1.SP
1400.00	2450.00	1100	1300	4240	90.70	N1084K.M1.SP
1020.00	1960.00	1100	1300	4500	60.20	N1988K.M1.SP
1560.00	2750.00	1100	1300	4580	106.00	N1088K.M1.SP
1060.00	2080.00	1100	1300	4740	62.60	N1992K.M1.SP
1660.00	3000.00	1000	1200	4760	120.00	N1092K.M1.SP
1140.00	2240.00	1000	1200	4870	73.10	N1996K.M1.SP
1700.00	3100.00	950	1100	4840	125.00	N1096K.M1.SP
1180.00	2360.00	1000	1200	5100	75.70	N19/500K.M1.SP
1760.00	3200.00	950	1100	5100	130.00	N10/500K.M1.SP



320
500

Hybrid design
HCN1014K.M1.SP

See Bearing Code, page 186

SUPER PRECISION CYLINDRICAL ROLLER BEARINGS

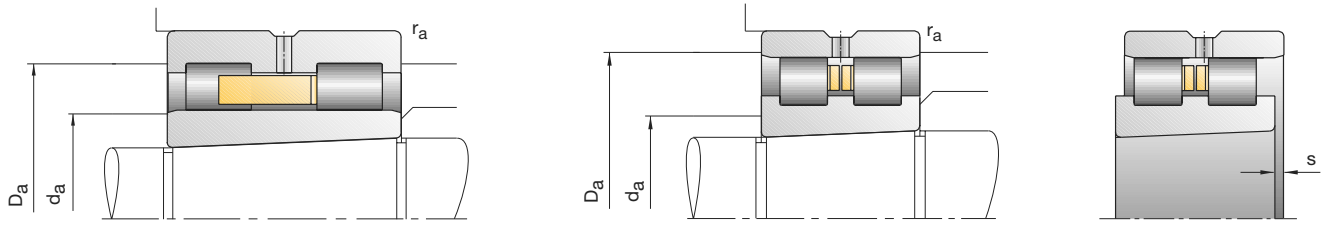

Bearing Code	Dimensions									Abutment Dimensions		
	d	D	B	r_{smin}	E	F	s	n_s	d_s	d_a H12	D_a H12	r_a max
FAG	mm											
NN3006ASK.M.SP	30	55	19	1.0	48.5		1.4	4.8	3.2	38	50	1.0
NN3007ASK.M.SP	35	62	20	1.0	55.0		1.4	4.8	3.2	43	57	1.0
NN3008ASK.M.SP	40	68	21	1.0	61.0		1.4	4.8	3.2	48	63	1.0
NN3009ASK.M.SP	45	75	23	1.0	67.5		1.7	4.8	3.2	54	69	1.0
NN3010ASK.M.SP	50	80	23	1.0	72.5		1.7	4.8	3.2	59	74	1.0
NN3011ASK.M.SP	55	90	26	1.1	81.0		1.9	4.8	3.2	65	83	1.1
NN3012ASK.M.SP	60	95	26	1.1	86.1		1.9	4.8	3.2	70	88	1.1
NN3013ASK.M.SP	65	100	26	1.1	91.0		1.9	4.8	3.2	75	93	1.1
NUU4914SK.M.SP	70	100	30	1.0		80.0	1.8	4.8	3.2	79	92	1.0
NN3014ASK.M.SP	70	110	30	1.1	100.0		2.3	6.5	3.2	82	102	1.1
NUU4915SK.M.SP	75	105	30	1.0		85.0	1.8	4.8	3.2	84	97	1.0
NN3015ASK.M.SP	75	115	30	1.1	105.0		2.3	6.5	3.2	87	107	1.1
NUU4916SK.M.SP	80	110	30	1.0		90.0	1.8	4.8	3.2	89	102	1.0
NN3016ASK.M.SP	80	125	34	1.1	113.0		2.5	6.5	3.2	93	116	1.1
NUU4917SK.M.SP	85	120	35	1.1		96.5	2.0	4.8	3.2	96	111	1.1
NN3017ASK.M.SP	85	130	34	1.1	118.0		2.5	6.5	3.2	98	121	1.1
NUU4918SK.M.SP	90	125	35	1.1		101.5	2.0	4.8	3.2	101	116	1.1
NN3018ASK.M.SP	90	140	37	1.5	127.0		2.6	6.5	3.2	105	130	1.5
NUU4919SK.M.SP	95	130	35	1.1		106.5	2.0	4.8	3.2	106	121	1.1
NN3019ASK.M.SP	95	145	37	1.5	132.0		2.6	6.5	3.2	110	135	1.5
NUU4920SK.M.SP	100	140	40	1.1		113.0	2.0	6.5	3.2	112	129	1.1
NN3020ASK.M.SP	100	150	37	1.5	137.0		2.6	6.5	3.2	115	140	1.5
Designation examples:					Standard design					Cylindrical bore		
					NUU4920SK.M.SP					NUU4920S.M.SP		
					NN3020ASK.M.SP					NN3020AS.M.SP		

SUPER PRECISION CYLINDRICAL ROLLER BEARINGS

NN30, NNU49

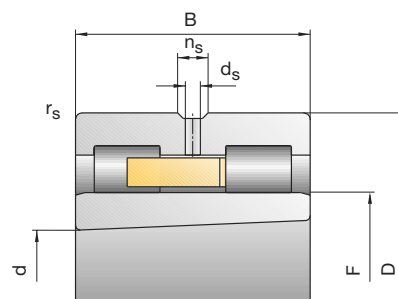
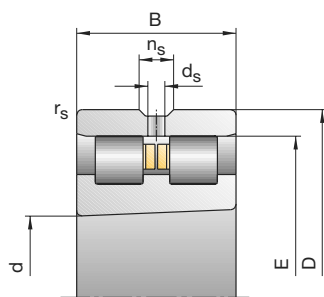

Load Ratings		Attainable Speed Grease	Oil minimal	Radial Stiffness C_s	Weight	Bearing Code
C_{dyn}	C_{0stat}					
kN		min^{-1}		$N/\mu m$	kg	FAG
29	34	16000	19000	680	0.19	NN3006ASK.M.SP
36	44	14000	17000	790	0.25	NN3007ASK.M.SP
45	59	12000	15000	950	0.30	NN3008ASK.M.SP
54	72	11000	14000	1080	0.39	NN3009ASK.M.SP
57	80	10000	13000	1180	0.43	NN3010ASK.M.SP
72	100	9000	11000	1300	0.63	NN3011ASK.M.SP
75	110	8500	10000	1410	0.67	NN3012ASK.M.SP
77	116	8000	9500	1470	0.72	NN3013ASK.M.SP
60	104	7500	9000	1700	0.73	NNU4914SK.M.SP
98	150	7000	8500	1660	1.04	NN3014ASK.M.SP
63	114	7000	8500	1870	0.77	NNU4915SK.M.SP
100	156	6700	8000	1730	1.09	NN3015ASK.M.SP
66	122	6700	8000	1980	0.81	NNU4916SK.M.SP
120	186	6300	7500	1850	1.51	NN3016ASK.M.SP
90	166	6300	7500	2280	1.20	NNU4917SK.M.SP
125	200	6000	7000	1990	1.58	NN3017ASK.M.SP
93	176	6000	7000	2420	1.26	NNU4918SK.M.SP
140	224	5600	6700	2020	2.05	NN3018ASK.M.SP
95	186	5600	6700	2560	1.32	NNU4919SK.M.SP
143	236	5300	6300	2100	2.14	NN3019ASK.M.SP
129	255	5300	6300	3000	1.86	NNU4920SK.M.SP
146	245	5300	6300	2170	2.23	NN3020ASK.M.SP

See Bearing Code, page 186



30
100

SUPER PRECISION CYLINDRICAL ROLLER BEARINGS

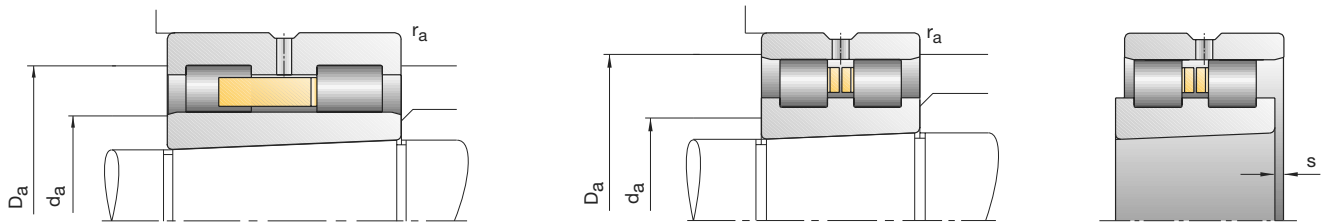

Bearing Code	Dimensions									Abutment Dimensions		
	d	D	B	r_{smin}	E	F	s	n_s	d_s	d_a H12	D_a H12	r_a max
FAG	mm											
NUU4921SK.M.SP	105	145	40	1.1		118.0	2.0	6.5	3.2	117	134	1.1
NN3021ASK.M.SP	105	160	41	2.0	146.0		2.6	6.5	3.2	120	149	2.0
NUU4922SK.M.SP	110	150	40	1.1		123.0	2.0	6.5	3.2	122	139	1.1
NN3022ASK.M.SP	110	170	45	2.0	155.0		2.9	6.5	3.2	127	158	2.0
NUU4924SK.M.SP	120	165	45	1.1		134.5	2.3	6.5	3.2	133	155	1.1
NN3024ASK.M.SP	120	180	46	2.0	165.0		3.1	6.5	3.2	137	168	2.0
NUU4926SK.M.SP	130	180	50	1.5		146.0	2.7	6.5	3.2	145	166	1.5
NN3026ASK.M.SP	130	200	52	2.0	182.0		3.1	9.5	4.8	150	186	2.0
NUU4928SK.M.SP	140	190	50	1.5		156.0	1.8	6.5	3.2	155	176	1.5
NN3028ASK.M.SP	140	210	53	2.0	192.0		3.4	9.5	4.8	160	196	2.0
NUU4930SK.M.SP	150	210	60	2.0		168.5	2.7	6.5	3.2	167	197	2.0
NN3030ASK.M.SP	150	225	56	2.1	206.0		3.8	9.5	4.8	172	210	2.1
NUU4932SK.M.SP	160	220	60	2.0		178.5	2.7	6.5	3.2	177	207	2.0
NN3032ASK.M.SP	160	240	60	2.1	219.0		4.3	9.5	4.8	183	224	2.1
NUU4934SK.M.SP	170	230	60	2.0		188.5	2.7	6.5	3.2	187	217	2.0
NN3034ASK.M.SP	170	260	67	2.1	236.0		4.6	9.5	4.8	196	241	2.1
NUU4936SK.M.SP	180	250	69	2.0		202.0	3.2	9.5	4.8	200	232	2.0
NN3036ASK.M.SP	180	280	74	2.1	255.0		4.8	12.2	6.3	209	260	2.1
NUU4938SK.M.SP	190	260	69	2.0		212.0	3.2	9.5	4.8	210	242	2.0
NN3038ASK.M.SP	190	290	75	2.1	265.0		4.8	12.2	6.3	219	271	2.1
NUU4940SK.M.SP	200	280	80	2.1		225.0	4.3	12.2	6.3	223	259	2.1
NN3040ASK.M.SP	200	310	82	2.1	282.0		5.7	12.2	6.3	232	288	2.1
NUU4944SK.M.SP	220	300	80	2.1		245.0	4.3	12.2	6.3	243	279	2.1
NN3044ASK.M.SP	220	340	90	3.0	310.0		5.7	15.0	8.0	254	317	3.0
Designation examples:					Standard design					Cylindrical bore		
					NUU4920SK.M.SP					NUU4920S.M.SP		
					NN3020ASK.M.SP					NN3020AS.M.SP		

SUPER PRECISION CYLINDRICAL ROLLER BEARINGS

NN30, NNU49

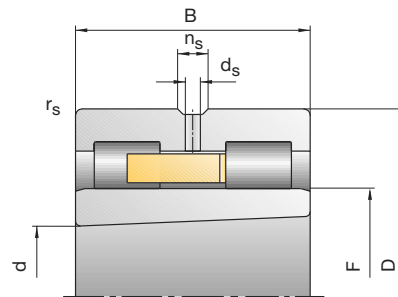
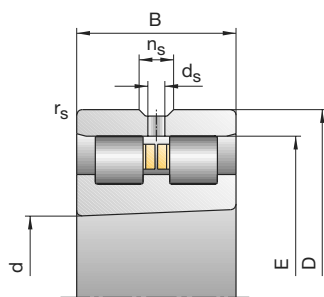

Load Ratings		Attainable Speed Grease	Oil minimal	Radial Stiffness C_s	Weight	Bearing Code
C_{dyn}	C_{0stat}					
kN		min^{-1}		$N/\mu m$	kg	FAG
129	260	5300	6300	3080	1.93	NNU4921SK.M.SP
190	310	4800	5600	2320	2.84	NN3021ASK.M.SP
132	270	5000	6000	3170	2.01	NNU4922SK.M.SP
220	360	4500	5300	2500	3.61	NN3022ASK.M.SP
176	340	4500	5300	3200	2.71	NNU4924SK.M.SP
232	390	4300	5000	2700	3.94	NN3024ASK.M.SP
190	390	4000	4800	3600	3.73	NNU4926SK.M.SP
290	500	3800	4500	2980	5.79	NN3026ASK.M.SP
190	400	3800	4500	3700	4.04	NNU4928SK.M.SP
300	520	3600	4300	3090	6.22	NN3028ASK.M.SP
325	655	3600	4300	4280	6.10	NNU4930SK.M.SP
335	585	3400	4000	3300	7.58	NN3030ASK.M.SP
335	680	3400	4000	4420	6.41	NNU4932SK.M.SP
375	670	3200	3800	3510	9.23	NN3032ASK.M.SP
340	695	3200	3800	4560	6.73	NNU4934SK.M.SP
450	800	3000	3600	3770	12.50	NN3034ASK.M.SP
405	850	3000	3600	5160	9.96	NNU4936SK.M.SP
570	1000	2800	3400	4040	16.40	NN3036ASK.M.SP
405	880	2800	3400	5310	10.40	NNU4938SK.M.SP
585	1040	2600	3200	4190	17.30	NN3038ASK.M.SP
490	1040	2600	3200	5510	14.70	NNU4940SK.M.SP
655	1200	2400	3000	4410	22.20	NN3040ASK.M.SP
510	1140	2400	3000	6000	15.90	NNU4944SK.M.SP
800	1460	2200	2800	4770	29.10	NN3044ASK.M.SP

See Bearing Code, page 186



105
220

SUPER PRECISION CYLINDRICAL ROLLER BEARINGS

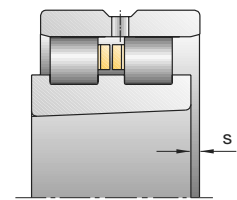
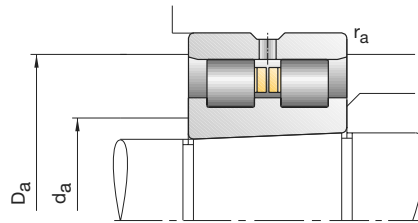
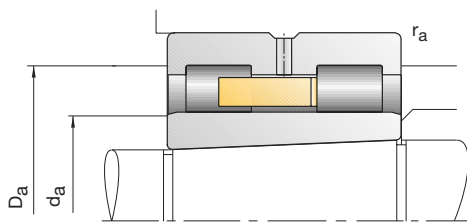

Bearing Code	Dimensions										Abutment Dimensions		
	d	D	B	r_{smin}	E	F	s	n_s	d_s	d_a H12	D_a H12	r_a max	
FAG	mm												
NNU4948SK.M.SP	240	320	80	2.1		265.0	4.3	12.2	6.3	263	299	2.1	
NN3048ASK.M.SP	240	360	92	3.0	330.0		6.1	15.0	8.0	274	337	3.0	
NNU4952SK.M.SP	260	360	100	2.1		292.0	5.4	15.0	8.0	289	334	2.1	
NN3052ASK.M.SP	260	400	104	4.0	364.0		6.6	15.0	8.0	300	372	4.0	
NNU4956SK.M.SP	280	380	100	2.1		312.0	5.4	15.0	8.0	309	354	2.1	
NN3056ASK.M.SP	280	420	106	4.0	384.0		6.9	15.0	8.0	320	392	4.0	
NNU4960SK.M.SP	300	420	118	3.0		339.0	6.3	17.7	9.5	336	389	3.0	
NN3060ASK.M.SP	300	460	118	4.0	418.0		7.5	17.7	9.5	346	427	4.0	
NNU4964SK.M.SP	320	440	118	3.0		359.0	6.3	17.7	9.5	356	409	3.0	
NN3064ASK.M.SP	320	480	121	4.0	438.0		8.0	17.7	9.5	366	447	4.0	
NNU4968SK.M.SP	340	460	118	3.0		379.0	6.3	17.7	9.5	376	429	3.0	
NN3068ASK.M.SP	340	520	133	5.0	473.0		8.8	17.7	9.5	393	483	5.0	
NNU4972SK.M.SP	360	480	118	3.0		399.0	6.3	17.7	9.5	396	449	3.0	
NN3072ASK.M.SP	360	540	134	5.0	493.0		8.8	17.7	9.5	413	503	5.0	
NNU4976SK.M.SP	380	520	140	4.0		426.0	7.2	17.7	9.5	423	482	4.0	
NN3076ASK.M.SP	380	560	135	5.0	513.0		9.1	17.7	9.5	433	523	5.0	
NNU4980SK.M.SP	400	540	140	4.0		446.0	7.2	17.7	9.5	443	502	4.0	
NN3080ASK.M.SP	400	600	148	5.0	549.0		9.5	17.7	9.5	459	560	5.0	
NNU4984SK.M.SP	420	560	140	4.0		466.0	7.2	17.7	9.5	463	522	4.0	
NN3084ASK.M.SP	420	620	150	5.0	569.0		10.0	17.7	9.5	479	580	5.0	
NNU4988SK.M.SP	440	600	160	4.0		490.0	6.8	17.7	9.5	487	558	4.0	
NN3088ASK.M.SP	440	650	157	6.0	597.0		10.2	23.5	12.5	501	609	6.0	
NNU4992SK.M.SP	460	620	160	4.0		510.0	6.8	17.7	9.5	507	578	4.0	
NN3092ASK.M.SP	460	680	163	6.0	624.0		10.9	23.5	12.5	524	636	6.0	
Designation examples:					Standard design					Cylindrical bore			
					NNU4920SK.M.SP					NNU4920S.M.SP			
					NN3020ASK.M.SP					NN3020AS.M.SP			

SUPER PRECISION CYLINDRICAL ROLLER BEARINGS

NN30, NNU49

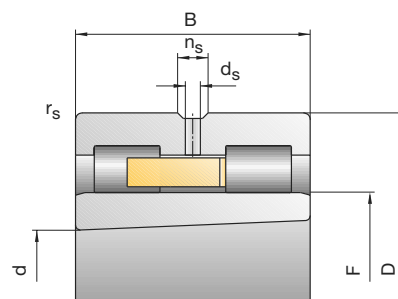
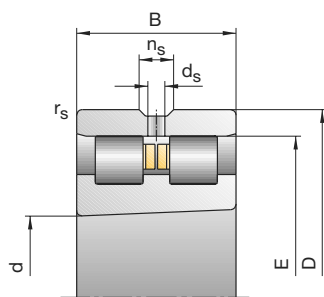

Load Ratings		Attainable Speed Grease	Oil minimal	Radial Stiffness C_s	Weight	Bearing Code
C_{dyn}	C_{0stat}					
kN		min^{-1}		$N/\mu m$	kg	FAG
530	1200	2200	2800	6320	17.10	NNU4948SK.M.SP
850	1560	2000	2600	5140	31.60	NN3048ASK.M.SP
750	1700	2000	2600	7080	29.70	NNU4952SK.M.SP
1060	2000	1900	2400	5680	46.20	NN3052ASK.M.SP
765	1800	1900	2400	7480	31.60	NNU4956SK.M.SP
1080	2080	1800	2200	5890	49.70	NN3056ASK.M.SP
1040	2400	1700	2000	8280	49.10	NNU4960SK.M.SP
1270	2400	1600	1900	5930	68.80	NN3060ASK.M.SP
1060	2550	1600	1900	8750	51.80	NNU4964SK.M.SP
1320	2600	1600	1900	6440	74.20	NN3064ASK.M.SP
1100	2650	1500	1800	9230	54.50	NNU4968SK.M.SP
1630	3250	1400	1700	7170	99.30	NN3068ASK.M.SP
1140	2800	1500	1800	9700	57.30	NNU4972SK.M.SP
1660	3350	1400	1700	7430	104	NN3072ASK.M.SP
1430	3600	1400	1700	10970	85.80	NNU4976SK.M.SP
1700	3450	1300	1600	7690	110	NN3076ASK.M.SP
1500	3800	1300	1600	11540	89.40	NNU4980SK.M.SP
2160	4500	1200	1500	8660	143	NN3080ASK.M.SP
1530	4000	1300	1600	12120	93.20	NNU4984SK.M.SP
2120	4500	1200	1500	8660	150	NN3084ASK.M.SP
2040	5200	1200	1500	12690	129	NNU4988SK.M.SP
2450	5100	1100	1400	9240	172	NN3088ASK.M.SP
2120	5500	1100	1400	13390	134	NNU4992SK.M.SP
2600	5400	1100	1400	9430	197	NN3092ASK.M.SP

See Bearing Code, page 186



240
—
460

SUPER PRECISION CYLINDRICAL ROLLER BEARINGS

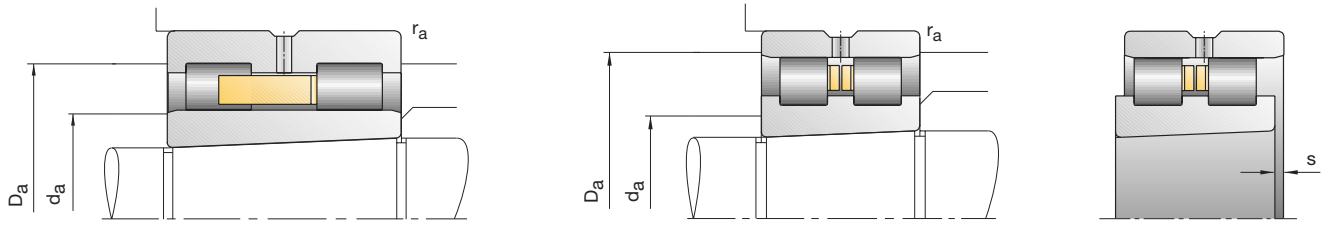

Bearing Code	Dimensions										Abutment Dimensions		
	d	D	B	r _{smin}	E	F	s	n _s	d _s	d _a H12	D _a H12	r _a max	
FAG	mm												
NNU4996SK.M.SP	480	650	170	5.0		534.0	7.2	17.7	9.5	531	606	5.0	
NN3096ASK.M.SP	480	700	165	6.0	644.0		11.2	23.5	12.5	544	656	6.0	
NNU49/500SK.M.SP	500	670	170	5.0		568.0	7.2	17.7	9.5	551	626	5.0	
NN30/500ASK.M.SP	500	720	167	6.0	664.0		11.7	23.5	12.5	564	677	6.0	
Designation examples:													
					Standard design				Cylindrical bore				
					NNU4920SK.M.SP				NNU4920S.M.SP				
					NN3020ASK.M.SP				NN3020AS.M.SP				

SUPER PRECISION CYLINDRICAL ROLLER BEARINGS

NN30, NNU49

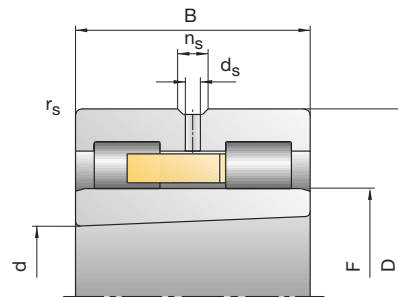
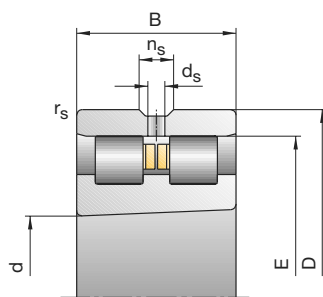

Load Ratings		Attainable Speed Grease	Oil minimal	Radial Stiffness C_s	Weight	Bearing Code
C_{dyn}	C_{0stat}					
kN		min^{-1}		$N/\mu m$	kg	FAG
2360	6100	1100	1400	14110	158	NNU4996SK.M.SP
2700	5850	1000	1300	10060	206	NN3096ASK.M.SP
2320	6100	1000	1300	14110	162	NNU49/500SK.M.SP
2650	5850	1000	1300	10060	214	NN30/500ASK.M.SP



480
—
500

See Bearing Code, page 186

DOUBLE DIRECTION ANGULAR CONTACT THRUST BALL BEARINGS



FAG double direction angular contact thrust ball bearings were developed for the machine tool industry and are manufactured exclusively as high-precision bearings. They accommodate axial loads in the main spindles of machine tools and exhibit the same abutment dimensions as double row cylindrical roller bearings of series NN30 (page 94) that take up the radial loads.

External Dimensions

Double direction angular contact ball bearings are mounted in combination with double row radial cylindrical roller bearings. The nominal outside diameters of the two bearings are identical. This facilitates the machining of the housing bore. The tolerance for the outside diameter of the angular contact thrust ball bearing has been determined in such a way that the bearings have a certain clearance in the housing bore.

Bearing Design

The double direction angular contact thrust ball bearings have a contact angle of 60° and are axially preloaded. This results in their high axial load carrying capacity and rigidity.

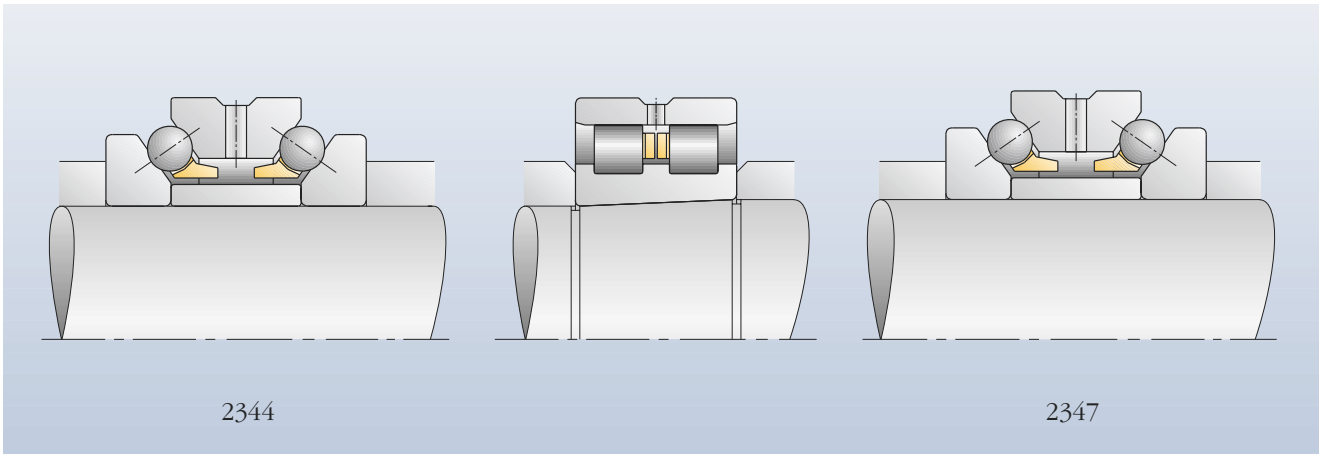

8: Mounting ends of double direction angular contact thrust ball bearings of series 2344 and 2347 in relation to double row cylindrical roller bearings

Lubrication

FAG angular contact thrust ball bearings can be lubricated either with grease or oil.

Their housing washers feature a lubricating groove and lubricating holes at the centre. The lubricant supply between the two rows of balls utilizes the conveying effect of the bearing. For this reason the bearings require a considerably greater amount of oil than a possibly adjacent cylindrical roller bearing. At the design stage, attention should therefore be paid to the fact that this oil flow should not all go to the cylindrical roller bearings.

DOUBLE DIRECTION ANGULAR CONTACT THRUST BALL BEARINGS

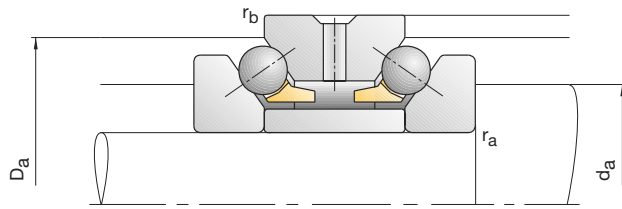

Bearing Code	Dimensions										Abutment Dimensions			
	d	D	B	r _{smin}	r _{1smin}	d ₁	B ₁	B _a	n _s	d _s	d _a h12	D _a H12	r _a max	r _b max
FAG	mm													
234406M.SP	30	55	32	1.00	0.15	47.0	8.0	16	4.8	3.2	40.5	50.5	1.00	0.15
234706M.SP	32	55	32	1.00	0.15	47.0	8.0	16	4.8	3.2	40.5	50.5	1.00	0.15
234407M.SP	35	62	34	1.00	0.15	53.0	8.5	17	4.8	3.2	46.5	57.0	1.00	0.15
234707M.SP	37	62	34	1.00	0.15	53.0	8.5	17	4.8	3.2	46.5	57.0	1.00	0.15
234408M.SP	40	68	36	1.00	0.15	58.5	9.0	18	4.8	3.2	51.5	63.5	1.00	0.15
234708M.SP	42	68	36	1.00	0.15	58.5	9.0	18	4.8	3.2	51.5	63.5	1.00	0.15
234409M.SP	45	75	38	1.00	0.15	65.0	9.5	19	4.8	3.2	57.5	70.0	1.00	0.15
234709M.SP	47	75	38	1.00	0.15	65.0	9.5	19	4.8	3.2	57.5	70.0	1.00	0.15
234410M.SP	50	80	38	1.00	0.15	70.0	9.5	19	4.8	3.2	62.5	75.0	1.00	0.15
234710M.SP	52	80	38	1.00	0.15	70.0	9.5	19	4.8	3.2	62.5	75.0	1.00	0.15
234411M.SP	55	90	44	1.10	0.30	78.0	11.0	22	6.5	3.2	69.0	84.5	1.10	0.30
234711M.SP	57	90	44	1.10	0.30	78.0	11.0	22	6.5	3.2	69.0	84.5	1.10	0.30
234412M.SP	60	95	44	1.10	0.30	83.0	11.0	22	6.5	3.2	74.0	89.5	1.10	0.30
234712M.SP	62	95	44	1.10	0.30	83.0	11.0	22	6.5	3.2	74.0	89.5	1.10	0.30
234413M.SP	65	100	44	1.10	0.30	88.0	11.0	22	6.5	3.2	79.0	94.5	1.10	0.30
234713M.SP	67	100	44	1.10	0.30	88.0	11.0	22	6.5	3.2	79.0	94.5	1.10	0.30
234414M.SP	70	110	48	1.10	0.30	97.0	12.0	24	6.5	3.2	86.5	103.5	1.10	0.30
234714M.SP	73	110	48	1.10	0.30	97.0	12.0	24	6.5	3.2	86.5	103.5	1.10	0.30
Designation examples:			Standard design					Standard design						
			234420M.SP					234720M.SP						

DOUBLE DIRECTION ANGULAR CONTACT THRUST BALL BEARINGS

2344, 2347

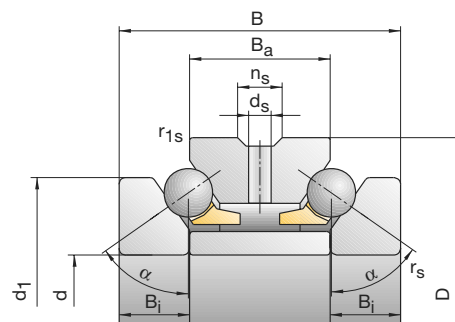

Load Ratings		Attainable Speed		Preloading Force F_V	Unloading Force K_{aE}	Axial Rigidity S_a	Weight	Bearing Code
C_{dyn}	C_{0stat}	Grease	Oil minimal					
kN		min^{-1}		N		$N/\mu m$	kg	FAG
14.30	24.00	11000	16000	108	308	276	0.29	234406M.SP
14.30	24.00	11000	16000	108	308	276	0.27	234706M.SP
17.60	31.50	9500	14000	134	382	316	0.38	234407M.SP
17.60	31.50	9500	14000	134	382	316	0.35	234707M.SP
20.80	38.00	8500	12000	160	456	354	0.46	234408M.SP
20.80	38.00	8500	12000	160	456	354	0.43	234708M.SP
23.20	45.00	7500	10000	180	514	387	0.58	234409M.SP
23.20	45.00	7500	10000	180	514	387	0.54	234709M.SP
24.00	49.00	7000	9500	183	522	410	0.63	234410M.SP
24.00	49.00	7000	9500	183	522	410	0.58	234710M.SP
34.00	67.00	6300	8500	260	743	458	0.94	234411M.SP
34.00	67.00	6300	8500	260	743	458	0.88	234711M.SP
33.50	68.00	6000	8000	255	728	455	1.01	234412M.SP
33.50	68.00	6000	8000	255	728	455	0.94	234712M.SP
36.00	76.50	5600	7500	275	785	506	1.08	234413M.SP
36.00	76.50	5600	7500	275	785	506	1.01	234713M.SP
42.50	93.00	5300	7000	325	926	552	1.49	234414M.SP
42.50	93.00	5300	7000	325	926	552	1.36	234714M.SP

See Bearing Code, page 190

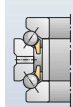

30
73

DOUBLE DIRECTION ANGULAR CONTACT THRUST BALL BEARINGS

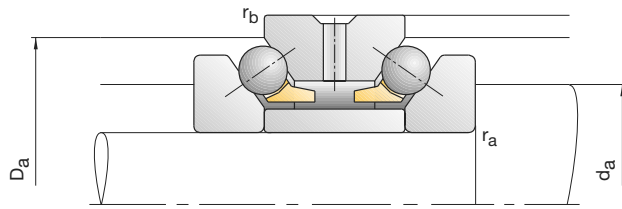

Bearing Code	Dimensions										Abutment Dimensions			
	d	D	B	r _{smin}	r _{1smin}	d ₁	B ₁	B _a	n _s	d _s	d _a h12	D _a H12	r _a max	r _b max
FAG	mm													
234415M.SP	75	115	48	1.10	0.30	102.0	12.0	24	6.5	3.2	91.5	108.5	1.10	0.30
234715M.SP	78	115	48	1.10	0.30	102.0	12.0	24	6.5	3.2	91.5	108.5	1.10	0.30
234416M.SP	80	125	54	1.10	0.30	110.0	13.5	27	6.5	3.2	98.5	117.0	1.10	0.30
234716M.SP	83	125	54	1.10	0.30	110.0	13.5	27	6.5	3.2	98.5	117.0	1.10	0.30
234417M.SP	85	130	54	1.10	0.30	115.0	13.5	27	9.5	4.8	103.5	122.0	1.10	0.30
234717M.SP	88	130	54	1.10	0.30	115.0	13.5	27	9.5	4.8	103.5	122.0	1.10	0.30
234418M.SP	90	140	60	1.50	0.30	123.0	15.0	30	9.5	4.8	110.5	130.5	1.50	0.30
234718M.SP	93	140	60	1.50	0.30	123.0	15.0	30	9.5	4.8	110.5	130.5	1.50	0.30
234419M.SP	95	145	60	1.50	0.30	128.0	15.0	30	9.5	4.8	115.5	135.5	1.50	0.30
234719M.SP	98	145	60	1.50	0.30	128.0	15.0	30	9.5	4.8	115.5	135.5	1.50	0.30
234420M.SP	100	150	60	1.50	0.30	133.0	15.0	30	9.5	4.8	120.5	140.5	1.50	0.30
234720M.SP	103	150	60	1.50	0.30	133.0	15.0	30	9.5	4.8	120.5	140.5	1.50	0.30
234421M.SP	105	160	66	2.00	0.60	142.0	16.5	33	9.5	4.8	128.0	150.0	2.00	0.60
234721M.SP	109	160	66	2.00	0.60	142.0	16.5	33	9.5	4.8	128.0	150.0	2.00	0.60
234422M.SP	110	170	72	2.00	0.60	150.0	18.0	36	9.5	4.8	134.5	160.0	2.00	0.60
234722M.SP	114	170	72	2.00	0.60	150.0	18.0	36	9.5	4.8	134.5	160.0	2.00	0.60
234424M.SP	120	180	72	2.00	0.60	160.0	18.0	36	9.5	4.8	144.5	170.0	2.00	0.60
234724M.SP	124	180	72	2.00	0.60	160.0	18.0	36	9.5	4.8	144.5	170.0	2.00	0.60
Designation examples:														
						Standard design				Standard design				
						234420M.SP				234720M.SP				

DOUBLE DIRECTION ANGULAR CONTACT THRUST BALL BEARINGS

2344, 2347

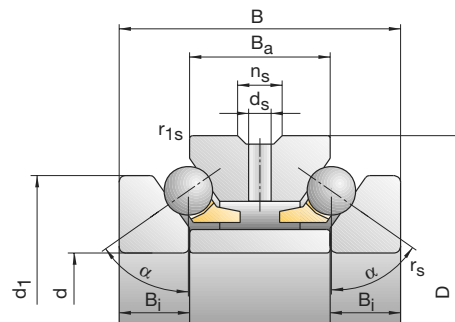

Load Ratings		Attainable Speed		Preloading Force F_V	Unloading Force K_{aE}	Axial Rigidity S_a	Weight	Bearing Code
C_{dyn}	C_{0stat}	Grease	Oil minimal					
kN		min^{-1}		N		$N/\mu m$	kg	FAG
44.00	100.00	5000	6700	340	969	589	1.57	234415M.SP
44.00	100.00	5000	6700	340	969	589	1.43	234715M.SP
52.00	120.00	4500	6000	400	1140	640	2.16	234416M.SP
52.00	120.00	4500	6000	400	1140	640	1.98	234716M.SP
52.00	125.00	4500	6000	400	1140	655	2.25	234417M.SP
52.00	125.00	4500	6000	400	1140	655	2.07	234717M.SP
61.00	146.00	4000	5300	465	1326	708	2.92	234418M.SP
61.00	146.00	4000	5300	465	1326	708	2.71	234718M.SP
61.00	150.00	4000	5300	465	1326	724	3.04	234419M.SP
61.00	150.00	4000	5300	465	1326	724	2.83	234719M.SP
62.00	156.00	3800	5000	685	1956	843	3.17	234420M.SP
62.00	156.00	3800	5000	685	1956	843	2.95	234720M.SP
69.50	176.00	3600	4800	530	1511	775	4.07	234421M.SP
69.50	176.00	3600	4800	530	1511	775	3.73	234721M.SP
90.00	224.00	3400	4500	695	1983	853	5.19	234422M.SP
90.00	224.00	3400	4500	695	1983	853	4.79	234722M.SP
93.00	240.00	3200	4300	960	2736	996	5.56	234424M.SP
93.00	240.00	3200	4300	960	2736	996	5.14	234724M.SP

See Bearing Code, page 190

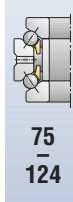

75
124

DOUBLE DIRECTION ANGULAR CONTACT THRUST BALL BEARINGS

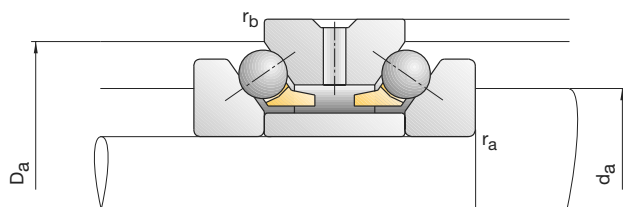

Bearing Code	Dimensions										Abutment Dimensions			
	d	D	B	r _{smin}	r _{1smin}	d ₁	B ₁	B _a	n _s	d _s	d _a h12	D _a H12	r _a max	r _b max
FAG	mm													
234426M.SP	130	200	84	2.00	0.60	177.0	21.0	42	12.2	6.3	159.0	188.0	2.00	0.60
234726M.SP	135	200	84	2.00	0.60	177.0	21.0	42	12.2	6.3	159.0	188.0	2.00	0.60
234428M.SP	140	210	84	2.10	0.60	187.0	21.0	42	12.2	6.3	169.0	198.0	2.10	0.60
234728M.SP	145	210	84	2.10	0.60	187.0	21.0	42	12.2	6.3	169.0	198.0	2.10	0.60
234430M.SP	150	225	90	2.10	0.60	200.0	22.5	45	15.0	8.0	181.0	211.5	2.10	0.60
234730M.SP	155	225	90	2.10	0.60	200.0	22.5	45	15.0	8.0	181.0	211.5	2.10	0.60
234432M.SP	160	240	96	2.10	0.60	212.0	24.0	48	15.0	8.0	192.5	226.0	2.10	0.60
234732M.SP	165	240	96	2.10	0.60	212.0	24.0	48	15.0	8.0	192.5	226.0	2.10	0.60
234434M.SP	170	260	108	2.10	0.60	230.0	27.0	54	15.0	8.0	206.5	245.0	2.10	0.60
234734M.SP	176	260	108	2.10	0.60	230.0	27.0	54	15.0	8.0	206.5	245.0	2.10	0.60
234436M.SP	180	280	120	2.10	0.60	248.0	30.0	60	15.0	8.0	221.0	263.0	2.10	0.60
234736M.SP	187	280	120	2.10	0.60	248.0	30.0	60	15.0	8.0	221.0	263.0	2.10	0.60
234438M.SP	190	290	120	2.10	0.60	258.0	30.0	60	15.0	8.0	231.0	273.0	2.10	0.60
234738M.SP	197	290	120	2.10	0.60	258.0	30.0	60	15.0	8.0	231.0	273.0	2.10	0.60
234440M.SP	200	310	132	2.10	0.60	274.0	33.0	66	15.0	8.0	245.0	291.5	2.10	0.60
234740M.SP	207	310	132	2.10	0.60	274.0	33.0	66	15.0	8.0	245.0	291.5	2.10	0.60
234444M.SP	220	340	144	3.00	1.10	304.0	36.0	72	17.7	9.5	269.0	318.0	3.00	1.10
234744M.SP	228	340	144	3.00	1.10	304.0	36.0	72	17.7	9.5	269.0	318.0	3.00	1.10
Designation examples:														
						Standard design				Standard design				
						234420M.SP				234720M.SP				

DOUBLE DIRECTION ANGULAR CONTACT THRUST BALL BEARINGS

2344, 2347

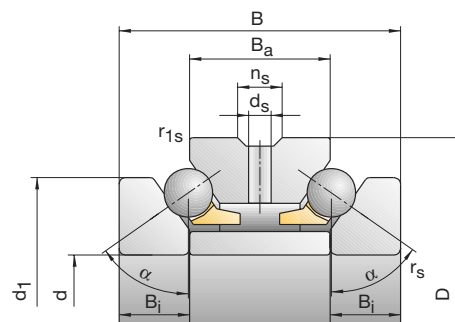

Load Ratings		Attainable Speed		Preloading Force F_V	Unloading Force K_{aE}	Axial Rigidity S_a	Weight	Bearing Code
C_{dyn}	C_{0stat}	Grease	Oil minimal					
kN		min^{-1}		N		$N/\mu m$	kg	FAG
118.00	300.00	2800	3800	900	2570	978	8.28	234426M.SP
118.00	300.00	2800	3800	900	2570	978	7.58	234726M.SP
122.00	320.00	2600	3600	930	2649	1034	8.78	234428M.SP
122.00	320.00	2600	3600	930	2649	1034	8.07	234728M.SP
132.00	355.00	2600	3600	1320	3764	1183	10.80	234430M.SP
132.00	355.00	2600	3600	1320	3764	1183	9.95	234730M.SP
156.00	415.00	2400	3400	1180	3362	1149	12.90	234432M.SP
156.00	415.00	2400	3400	1180	3362	1149	12.00	234732M.SP
193.00	520.00	2200	3200	1847	5270	1362	17.70	234434M.SP
193.00	520.00	2200	3200	1847	5270	1362	16.30	234734M.SP
216.00	585.00	2000	3000	1660	4733	1315	23.40	234436M.SP
216.00	585.00	2000	3000	1660	4733	1315	21.50	234736M.SP
224.00	630.00	1900	2800	2110	6021	1495	24.70	234438M.SP
224.00	630.00	1900	2800	2110	6021	1495	22.60	234738M.SP
265.00	720.00	1800	2600	2000	5704	1449	31.50	234440M.SP
265.00	720.00	1800	2600	2000	5704	1449	29.20	234740M.SP
315.00	900.00	1600	2200	2400	6848	1629	41.70	234444M.SP
315.00	900.00	1600	2200	2400	6848	1629	38.50	234744M.SP

See Bearing Code, page 190

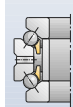

130
-
228

DOUBLE DIRECTION ANGULAR CONTACT THRUST BALL BEARINGS

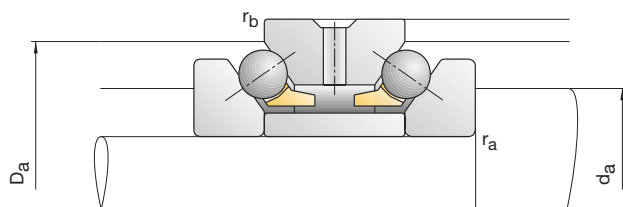

Bearing Code	Dimensions										Abutment Dimensions			
	d	D	B	r _{smin}	r _{1smin}	d ₁	B ₁	B _a	n _s	d _s	d _a h12	D _a H12	r _a max	r _b max
FAG	mm													
234448M.SP	240	360	144	3.00	1.10	322.0	36.0	72	17.7	9.5	289.0	338.0	3.00	1.10
234748M.SP	248	360	144	3.00	1.10	322.0	36.0	72	17.7	9.5	289.0	338.0	3.00	1.10
234452M.SP	260	400	164	4.00	1.50	354.0	41.0	82	17.7	9.5	317.5	374.5	4.00	1.50
234752M.SP	269	400	164	4.00	1.50	354.0	41.0	82	17.7	9.5	317.5	374.5	4.00	1.50
234456M.SP	280	420	164	4.00	1.50	374.0	41.0	82	17.7	9.5	337.5	394.5	4.00	1.50
234756M.SP	289	420	164	4.00	1.50	374.0	41.0	82	17.7	9.5	337.5	394.5	4.00	1.50
234460M.SP	300	460	190	4.00	1.50	406.0	47.5	95	17.7	9.5	366.0	428.5	4.00	1.50
234760M.SP	310	460	190	4.00	1.50	406.0	47.5	95	17.7	9.5	366.0	428.5	4.00	1.50
234464M.SP	320	480	190	4.00	1.50	426.0	47.5	95	17.7	9.5	386.0	448.5	4.00	1.50
234764M.SP	330	480	190	4.00	1.50	426.0	47.5	95	17.7	9.5	386.0	448.5	4.00	1.50
234468M.SP	340	520	212	4.00	1.50	459.0	53.0	106	17.7	9.5	413.0	485.5	4.00	1.50
234768M.SP	350	520	212	4.00	1.50	459.0	53.0	106	17.7	9.5	413.0	485.5	4.00	1.50
234472M.SP	360	540	212	4.00	1.50	479.0	53.0	106	17.7	9.5	433.0	505.5	4.00	1.50
234772M.SP	370	540	212	4.00	1.50	479.0	53.0	106	17.7	9.5	433.0	505.5	4.00	1.50
234476M.SP	380	560	212	4.00	1.50	499.0	53.0	106	17.7	9.5	453.0	525.5	4.00	1.50
234776M.SP	390	560	212	4.00	1.50	499.0	53.0	106	17.7	9.5	453.0	525.5	4.00	1.50
234480M.SP	400	600	236	5.00	2.00	532.0	59.0	118	17.7	9.5	480.0	561.5	5.00	2.00
234780M.SP	410	600	236	5.00	2.00	532.0	59.0	118	17.7	9.5	480.0	561.5	5.00	2.00
Designation examples:														
						Standard design				Standard design				
						234420M.SP				234720M.SP				

DOUBLE DIRECTION ANGULAR CONTACT THRUST BALL BEARINGS

2344, 2347

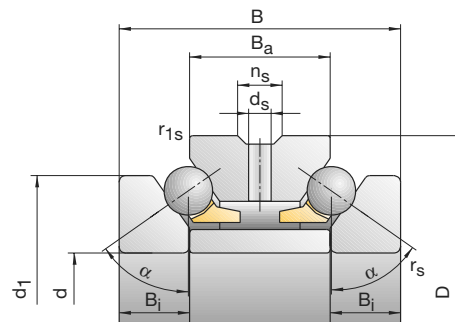

Load Ratings		Attainable Speed		Preloading Force F_V	Unloading Force K_{aE}	Axial Rigidity S_a	Weight	Bearing Code
C_{dyn}	C_{0stat}	Grease	Oil minimal					
kN		min^{-1}		N		$N/\mu m$	kg	FAG
325.00	965.00	1500	2000	2500	7134	1729	43.80	234448M.SP
325.00	965.00	1500	2000	2500	7134	1729	40.40	234748M.SP
380.00	1180.00	1400	1900	2900	8257	1814	64.50	234452M.SP
380.00	1180.00	1400	1900	2900	8257	1814	59.70	234752M.SP
390.00	1270.00	1300	1800	3000	8542	1920	69.00	234456M.SP
390.00	1270.00	1300	1800	3000	8542	1920	63.80	234756M.SP
450.00	1530.00	1200	1700	3400	9682	2027	98.40	234460M.SP
450.00	1530.00	1200	1700	3400	9682	2027	91.20	234760M.SP
455.00	1630.00	1200	1700	3550	10109	2150	102.00	234464M.SP
455.00	1630.00	1200	1700	3550	10109	2150	94.90	234764M.SP
540.00	2000.00	1100	1600	4150	11820	2265	138.00	234468M.SP
540.00	2000.00	1100	1600	4150	11820	2265	129.00	234768M.SP
540.00	2040.00	1000	1500	4150	11820	2317	144.00	234472M.SP
540.00	2040.00	1000	1500	4150	11820	2317	135.00	234772M.SP
560.00	2200.00	1000	1500	4300	12248	2447	154.00	234476M.SP
560.00	2200.00	1000	1500	4300	12248	2447	144.00	234776M.SP
630.00	2550.00	900	1300	4900	13959	2539	198.00	234480M.SP
630.00	2550.00	900	1300	4900	13959	2539	187.00	234780M.SP

See Bearing Code, page 190



ANGULAR CONTACT THRUST BALL BEARINGS FOR BALL SCREWS



FAG angular contact thrust ball bearings have been designed especially for ball screw bearing arrangements. They offer

- high accuracy
- great rigidity
- low friction
- high speeds for quick positional changes.

All designs have been optimised for grease lubrication. The sealed bearing versions are lubricated with the well-proven FAG grease Arcanol L55. This grease stands out in particular through its special EP additives that resist higher loads

and periods of sliding friction.

Greased open bearings can be supplied on request.

FAG angular contact thrust ball bearings are manufactured with narrow tolerances as standard. Simple ball screw applications can be supported cost-efficiently with bearings of specification T59.

Single row bearings of series

- 7602
- 7603
- BSB

are designed as universal bearings.

They can be arranged in sets ac-

ording to preference so that they will meet the specific operating conditions in the best possible way. All FAG angular contact thrust ball bearings for ball screws have a contact angle of 60°. The arrangement in sets is facilitated through markings on the outer ring surface.

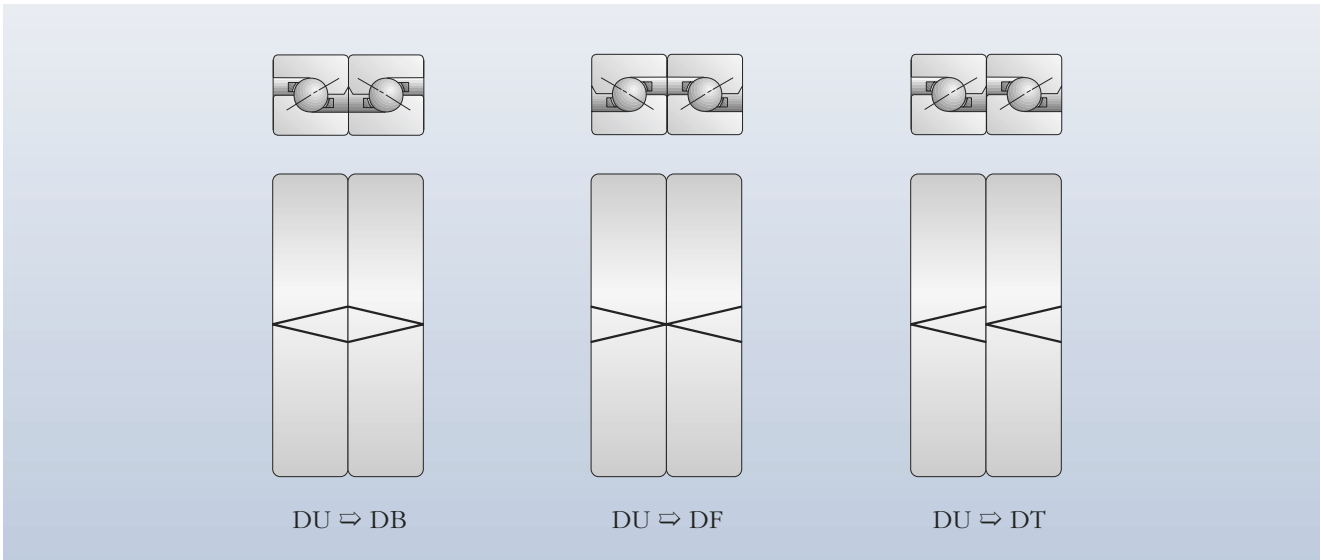

9: The universal system permits the arrangement of any set desired



10: Sealed angular thrust ball bearing for ball screws



11: Angular contact thrust ball bearings for ball screws

ANGULAR CONTACT THRUST BALL BEARINGS FOR BALL SCREWS

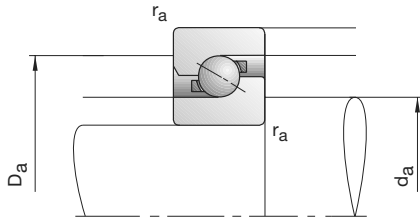

Bearing Code	Dimensions				Abutment Dimensions			Load Ratings	
	d	D	B	r _{smin}	d _a h12	D _a H12	r _a max	C _{dyn}	C _{0stat}
FAG	mm							kN	
7602012TVP	12	32	10	0.6	17.0	27.0	0.6	11.60	12.50
7602015TVP	15	35	11	0.6	20.5	30.0	0.6	12.50	15.00
7602017TVP	17	40	12	0.6	23.0	34.5	0.6	16.60	20.00
7602020TVP	20	47	14	1.0	27.5	39.5	1.0	19.30	25.00
BSB020047T	20	47	15	1.0	27.5	39.5	1.0	19.30	25.00
7603020TVP	20	52	15	1.1	30.5	43.5	1.1	24.50	32.00
7602025TVP	25	52	15	1.0	32.0	45.0	1.0	22.00	30.50
BSB025062T	25	62	15	1.0	38.0	52.0	1.0	28.50	41.50
7603025TVP	25	62	17	1.1	38.0	52.0	1.1	28.50	41.50
BSB030062T	30	62	15	1.0	39.5	52.5	1.0	26.00	39.00
7602030TVP	30	62	16	1.0	39.5	52.5	1.0	26.00	39.00
7603030TVP	30	72	19	1.1	45.0	61.0	1.1	34.50	55.00
BSB035072T	35	72	15	1.0	46.5	60.5	1.1	30.00	50.00
7602035TVP	35	72	17	1.1	46.5	60.5	1.0	30.00	50.00
7603035TVP	35	80	21	1.5	51.0	67.0	1.5	36.50	61.00
BSB040072T	40	72	15	1.0	49.0	62.5	1.1	28.00	49.00
7602040TVP	40	80	18	1.1	53.5	69.5	1.1	37.50	64.00
BSB040090T	40	90	20	1.5	56.5	75.5	1.5	50.00	83.00
7603040TVP	40	90	23	1.5	56.5	75.5	1.5	50.00	83.00
BSB045075T	45	75	15	1.0	52.0	68.0	1.0	28.50	52.00
7602045TVP	45	85	19	1.1	57.0	73.0	1.1	38.00	68.00
BSB045100T	45	100	20	1.5	64.5	85.5	1.5	58.50	104.00
7603045TVP	45	100	25	1.5	64.5	85.5	1.5	58.50	104.00
7602050TVP	50	90	20	1.1	63.0	79.0	1.1	39.00	75.00
BSB050100T	50	100	20	1.5	64.5	85.5	1.5	58.50	104.00
7603050TVP	50	110	27	2.0	72.0	94.0	2.0	69.50	127.00
Designation examples:					Standard design			Set design	
					7602020TVP			7602020TVP.D	
					BSB020047T			BSB020047T.D	

ANGULAR CONTACT THRUST BALL BEARINGS FOR BALL SCREWS

7602, 7603, BSB

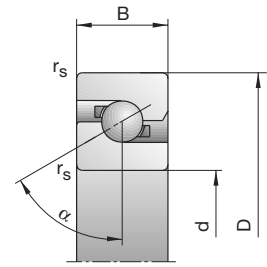

Attainable Speed Grease	Oil minimal	Preloading Force F_V	Unloading Force* K_{aE}	Axial Rigidity* S_a	Max. Dynamic Axial Load	Friction Torque M_r	Weight	Bearing Code
min ⁻¹		N		N/μm	kN	Nmm	kg	FAG
17000	24000	1375	3990	476	5.2	15	0.042	7602012TVP
15000	20000	1310	3792	516	6.3	20	0.052	7602015TVP
13000	18000	1728	5005	596	8.5	30	0.075	7602017TVP
12000	17000	2297	6645	703	10.6	50	0.12	7602020TVP
12000	17000	2297	6645	703	10.6	50	0.13	BSB020047T
11000	16000	2853	8254	787	14.0	60	0.17	7603020TVP
11000	16000	2519	7281	772	13.2	65	0.15	7602025TVP
9000	13000	3324	9611	917	18.0	85	0.24	BSB025062T
9000	13000	3324	9611	917	18.0	85	0.27	7603025TVP
9000	13000	2918	8429	893	17.0	85	0.22	BSB030062T
9000	13000	2918	8429	893	17.0	85	0.23	7602030TVP
8000	11000	4279	12378	1073	23.6	130	0.41	7603030TVP
8000	11000	3333	9623	1020	21.2	115	0.30	BSB035072T
8000	11000	3333	9623	1020	21.2	115	0.34	7602035TVP
7000	9500	4755	13760	1192	26.5	170	0.55	7603035TVP
8000	11000	2900	8361	1016	21.2	115	0.26	BSB040072T
7000	9500	4321	12483	1190	28.0	170	0.43	7602040TVP
6300	8500	5629	16273	1292	35.5	225	0.65	BSB040090T
6300	8500	5629	16273	1292	35.5	225	0.75	7603040TVP
7500	10000	3119	8996	1072	22.4	130	0.26	BSB045075T
6700	9000	4527	13080	1247	28.0	190	0.49	7602045TVP
5600	7500	6955	20065	1473	45.0	300	0.81	BSB045100T
5600	7500	6955	20065	1473	45.0	300	1.0	7603045TVP
6300	8500	4938	14271	1360	31.5	230	0.56	7602050TVP
5600	7500	6955	20065	1473	45.0	330	0.75	BSB050100T
5000	6700	7570	21820	1601	53.0	360	1.3	7603050TVP

Sealed design

7602020.**2RS**.TVP

BSB020047.**2RS**.T

See Bearing Code, page 194

* only for sets

ANGULAR CONTACT THRUST BALL BEARINGS FOR BALL SCREWS

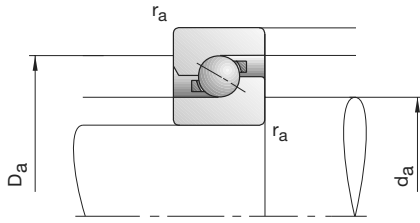

Bearing Code	Dimensions				Abutment Dimensions			Load Ratings	
	d	D	B	r _{smin}	d _a h12	D _a H12	r _a max	C _{dyn}	C _{0stat}
FAG	mm							kN	
BSB055090T	55	90	15	1.0	65.0	80.0	1.0	32.50	65.50
7602055TVP	55	100	21	1.5	69.5	85.5	1.5	40.50	81.50
BSB055120T	55	120	20	2.0	77.0	97.5	2.0	60.00	116.00
7603055TVP	55	120	29	2.0	77.0	101.0	2.0	78.00	146.00
7602060TVP	60	110	22	1.5	77.0	96.0	1.5	56.00	112.00
BSB060120T	60	120	20	1.5	79.5	100.5	1.5	61.00	120.00
7603060TVP	60	130	31	2.1	82.5	107.5	2.1	88.00	166.00
7602065TVP	65	120	23	1.5	84.0	103.0	1.5	57.00	122.00
7603065TVP	65	140	33	2.1	91.5	118.5	2.1	100.00	196.00
7602070TVP	70	125	24	1.5	87.0	108.0	1.5	65.50	137.00
7603070TVP	70	150	35	2.1	95.5	124.5	2.1	110.00	220.00
BSB075110T	75	110	15	1.5	85.0	99.5	1.5	35.50	83.00
7602075TVP	75	130	25	1.5	93.5	114.5	1.5	67.00	150.00
7603075TVP	75	160	37	2.1	105.5	135.5	2.1	125.00	255.00
7602080TVP	80	140	26	2.0	100.0	122.0	2.0	76.50	173.00
7603080TVP	80	170	39	2.1	111.0	143.0	2.1	137.00	285.00
7602085TVP	85	150	28	2.0	107.0	131.0	2.0	86.50	196.00
7603085TVP	85	180	41	3.0	116.0	151.0	3.0	160.00	325.00
7602090TVP	90	160	30	2.0	113.5	138.5	2.0	98.00	224.00
7603090TVP	90	190	43	3.0	122.5	157.5	3.0	163.00	345.00
7602095TVP	95	170	32	2.1	119.5	146.5	2.1	110.00	255.00
7603095TVP	95	200	45	3.0	130.0	165.0	3.0	163.00	360.00
BSB100150T	100	150	22.5	2.0	114.5	135.0	2.0	69.50	173.00
7602100TVP	100	180	34	2.1	125.5	154.5	2.1	122.00	285.00
7603100TVP	100	215	47	3.0	140.0	178.0	3.0	193.00	430.00
Designation examples:					Standard design			Set design	
					7602020TVP			7602020TVP.D	
					BSB020047T			BSB020047T.D	

ANGULAR CONTACT THRUST BALL BEARINGS FOR BALL SCREWS

7602, 7603, BSB

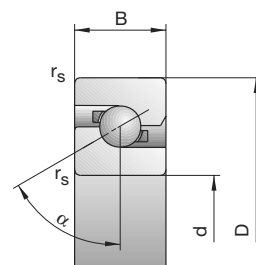

Attainable Speed Grease	Oil minimal	Preloading Force F_V	Unloading Force* K_{aE}	Axial Rigidity* S_a	Max. Dynamic Axial Load	Friction Torque M_r	Weight	Bearing Code
min ⁻¹		N		N/μm	kN	Nmm	kg	FAG
6300	8500	3625	10452	1246	28.0	190	0.38	BSB055090T
6000	8000	4561	13160	1394	33.5	250	0.75	7602055TVP
5000	6700	6777	19530	1553	50.0	360	1.2	BSB055120T
4800	6300	8791	25349	1723	63.0	460	1.7	7603055TVP
5000	6700	6493	18709	1623	47.5	350	0.94	7602060TVP
4800	6300	7085	20419	1623	53.0	380	1.1	BSB060120T
4500	6000	10031	28933	1840	75.0	540	2.1	7603060TVP
4800	6300	7012	20207	1753	50.0	410	1.2	7602065TVP
4000	5300	11937	34447	2052	90.0	700	2.6	7603065TVP
4500	6000	7021	20212	1753	56.0	440	1.3	7602070TVP
3800	5000	12271	35386	2108	95.0	760	3.2	7603070TVP
5000	6700	4462	12872	1534	33.5	290	0.47	BSB075110T
4300	5600	7561	21770	1888	63.0	480	1.4	7602075TVP
3600	4800	14436	41650	2335	118.0	920	3.8	7603075TVP
4000	5300	8941	25755	2047	75.0	600	1.7	7602080TVP
3400	4500	16138	46579	2466	132.0	1100	4.5	7603080TVP
3800	5000	10477	30195	2209	85.0	760	2.2	7602085TVP
3200	4300	17548	50625	2539	150.0	1250	5.2	7603085TVP
3600	4800	10771	31018	2275	100.0	790	2.7	7602090TVP
3000	4000	18345	52925	2654	160.0	1300	6.2	7603090TVP
3400	4500	12413	35764	2435	112.0	950	3.3	7602095TVP
3000	4000	19143	55228	2770	170.0	1450	7.2	7603095TVP
3800	5000	7481	21516	2052	71.0	600	1.4	BSB100150T
3200	4300	14164	40828	2594	125.0	1100	3.9	7602100TVP
2600	3600	21584	62216	2965	212.0	1700	8.8	7603100TVP

Sealed design

7602020.**2RS**.TVP

BSB020047.**2RS**.T

See Bearing Code, page 194

* only for sets



55
100

ANGULAR CONTACT THRUST BALL BEARINGS FOR BALL SCREWS

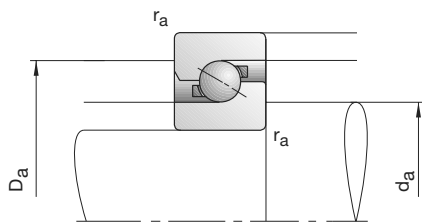

Bearing Code	Dimensions				Abutment Dimensions			Load Ratings	
	d	D	B	r_{smin}	d_a h12	D_a H12	r_a max	C _{dyn}	C _{0stat}
FAG	mm							kN	
7602110TVP	110	200	38	2.1	139.0	171.0	2.1	146.00	355.00
7603110TVP	110	240	50	3.0	154.5	200.0	3.0	250.00	560.00
7602120TVP	120	215	40	2.1	150.0	185.0	2.1	176.00	425.00
7602130TVP	130	230	40	3.0	162.5	197.0	3.0	180.00	455.00
7603130TVP	130	280	58	3.0	181.0	229.0	3.0	290.00	695.00
Designation examples:			Standard design			Set design			
			7602020TVP			7602020TVP.D			
			BSB020047T			BSB020047T.D			

ANGULAR CONTACT THRUST BALL BEARINGS FOR BALL SCREWS

7602, 7603, BSB

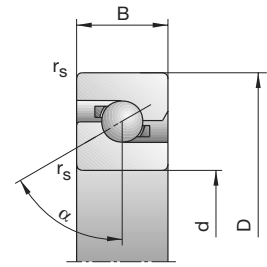

Attainable Speed		Preloading Force	Unloading Force*	Axial Rigidity*	Max. Dynamic Axial Load	Friction Torque	Weight	Bearing Code
Grease	Oil minimal	F _v	K _{aE}	S _a		M _r		
min ⁻¹		N		N/μm	kN	Nmm	kg	FAG
2800	3800	16440	47385	2822	153.0	1400	5.5	7602110TVP
2400	3400	29379	84612	3363	265.0	2500	11.8	7603110TVP
2600	3600	20580	59213	3139	185.0	2000	6.5	7602120TVP
2400	3400	20650	59389	3287	200.0	2100	7.4	7602130TVP
2000	3000	33760	97158	3806	305.0	3100	18.7	7603130TVP



110
-
130

Sealed design
7602020.**2RS**.TVP
BSB020047.**2RS**.T

See Bearing Code, page 194
* only for sets

AXIAL-RADIAL CYLINDRICAL ROLLER BEARINGS



FAG axial-radial cylindrical roller bearings for rotary tables, face plates and other high-precision bearing arrangements have a long tradition at FAG. Meanwhile they were developed into true super precision products. Even in their standard version they exhibit accuracies better than P4 for important bearing features. FAG RTC bearings are equipped with high-precision rollers that are otherwise in-

corporated only in super precision cylindrical roller bearings and are fitted with precision cages. In addition the ring raceways exhibit a high surface quality.

The consistent super precision design results in significantly improved speed behaviour. Without any loss in rigidity, it permits the speeds required in turning and milling operations.

The high internal accuracy is also a prerequisite for steady load distribution and thus high rigidity.

FAG RTC bearings are easy to handle. Fastening holes at the inner and outer rings enable a reliable and rigid connection with the surrounding structure. Through-holes at the inner rings facilitate the mounting on a shaft.

FAG RTC bearings are lubricated with FAG grease Arcanol L55.



12: Super precision components ensure the enhanced performance of RTC bearings

Having undergone intensive tests, this grease excels especially by its high load carrying capacity. In connection with the high-grade surfaces, this results in long service life.

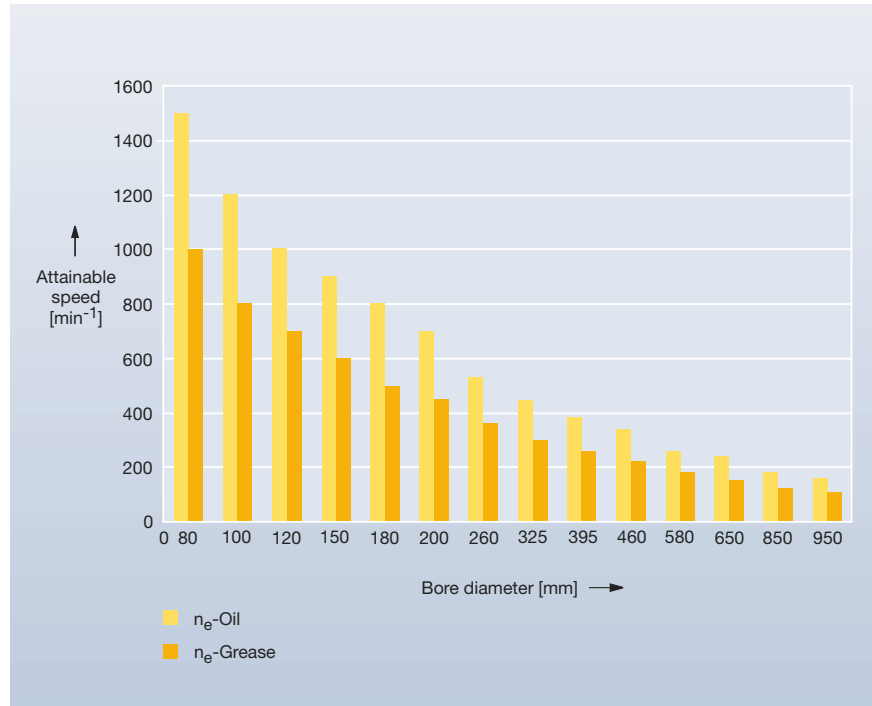

13: Higher speeds attainable for RTC bearings



AXIAL-RADIAL CYLINDRICAL ROLLER BEARINGS

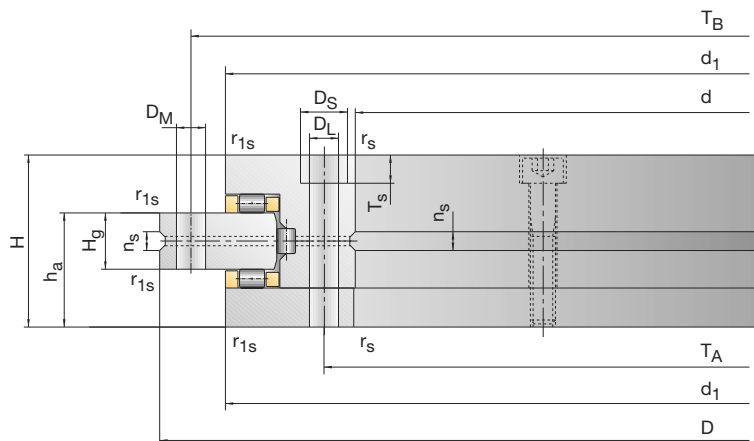

Bearing Code	Dimensions									
	d	D	H	h _a	H _g	d ₁	n _s	r _a	r _b	r _{1smin}
FAG	mm									
RTC080	80	146	35	23.35	12	130	2.7	0.3	0.3	
RTC100	100	185	38	25.0	12	160	4	0.3	0.6	
RTC120	120	210	40	26.0	12	184	4	0.3	0.6	
RTC150	150	240	40	26.0	12	212	4	0.3	0.6	
RTC180	180	280	43	29.0	15	242	4	0.3	0.6	
RTC200	200	300	45	30.0	15	272	4	0.3	0.6	
RTC260	260	385	55	36.5	18	343	6	0.6	0.6	
RTC325	325	450	60	40.0	20	413	6	0.6	0.6	
RTC395	395	525	65	42.5	20	484	6	1.0	1.0	
RTC460	460	600	70	46.0	22	558	7	1.0	1.0	
RTC580	580	750	90	60.0	30	698	9	1.0	1.0	
RTC650	650	870	122	78.0	34	798	10	1.0	1.0	
RTC850	850	1095	124	80.5	37	1016	10	1.5	1.5	
RTC950	950	1200	132	86.0	40	1128	10	1.5	1.5	
Designation examples:			Standard design				Enhanced-precision design			
			RTC325				RTC325.T52E			

AXIAL-RADIAL CYLINDRICAL ROLLER BEARINGS

RTC

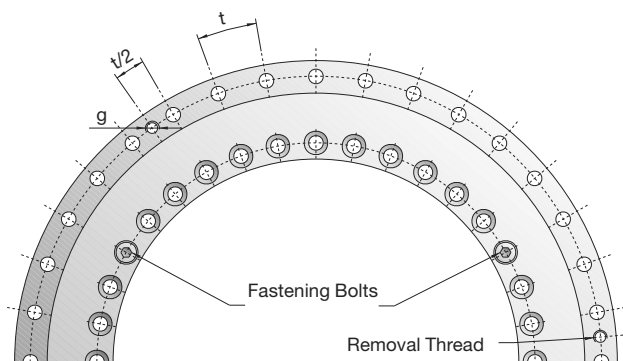

Fastening Holes Inner Ring						Outer Ring						Bearing Code
T_A	D_L	D_S	T_S	Number	Fastening Bolts Number	T_B	D_M	Number z	Removal Thread g	Number	Pitch $z \times t$	FAG
92	5.6	10	5.7	12	3	138	4.6	12	–	–	12 x 30°	RTC080
112	5.6	10	5.7	15	3	170	5.6	18	M5	3	18 x 20°	RTC100
135	7.0	11	7.0	21	3	195	7.0	24	M6	3	24 x 15°	RTC120
165	7.0	11	7.0	33	3	225	7.0	36	M6	3	36 x 10°	RTC150
194	7.0	11	7.0	45	3	260	7.0	48	M6	3	48 x 7.5°	RTC180
215	7.0	11	7.0	45	3	285	7.0	48	M6	3	48 x 7.5°	RTC200
280	9.3	15	9.3	33	3	365	9.3	36	M8	3	36 x 10°	RTC260
342	9.3	15	9.3	33	3	430	9.3	36	M8	3	36 x 10°	RTC325
415	9.3	15	9.3	45	3	505	9.3	48	M8	3	48 x 7.5°	RTC395
482	9.3	15	9.3	45	3	580	9.3	48	M8	3	48 x 7.5°	RTC460
610	11.4	18	11.0	42	6	720	11.4	48	M10	6	48 x 7.5°	RTC580
680	14.0	20	13.0	42	6	830	14.0	48	M12	6	48 x 7.5°	RTC650
890	18.0	26	17.5	54	6	1055	18.0	60	M16	6	60 x 6°	RTC850
990	18.0	26	17.5	54	6	1160	18.0	60	M16	6	60 x 6°	RTC950

Enhanced-precision design, reduced axial preload
RTC325.T52EA

For further bearing data see following pages
See Bearing Code, page 198

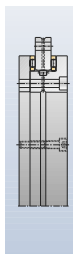

AXIAL-RADIAL CYLINDRICAL ROLLER BEARINGS

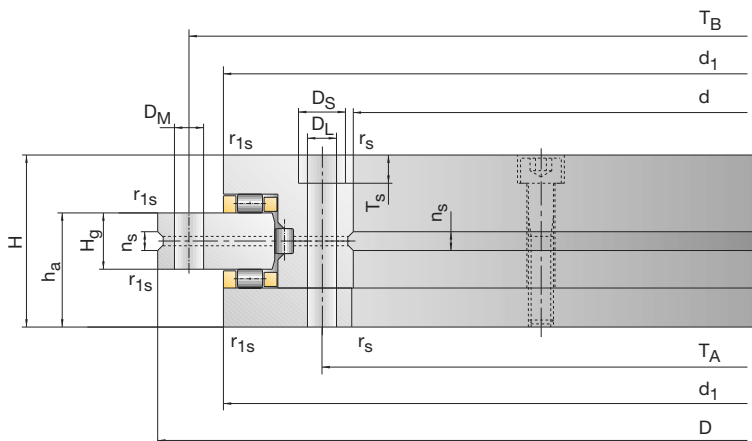

Bearing Code	Load Ratings				Attainable Speed		Axial Preload	Axial Unloading Force	Axial Rigidity	mounted	
	C _{dyn. axial} kN	C _{0 stat.}	C _{dyn. radial}	C _{0 stat.}	Grease min ⁻¹	Oil	F _V kN	K _{aE}	S _a kN/μm	S _{a1}	
FAG											
RTC080	56	255	42.5	100	1000	1500	10.4	22	4.4	0.7	
RTC100	76.5	415	47.5	120	800	1200	30.2	64	7.1	1.2	
RTC120	102	540	52	143	700	1000	36	76	7.6	1.3	
RTC150	112	630	56	170	600	900	42.3	90	9	1.5	
RTC180	118	710	69.5	200	500	800	47.6	101	10.1	1.7	
RTC200	120	765	81.5	220	450	700	50.8	107	10.7	1.8	
RTC260	160	1060	93	290	360	530	58.7	124	12.4	2.1	
RTC325	275	1930	120	345	300	450	80.8	171	17.1	2.8	
RTC395	300	2280	186	655	260	380	107	226	20.6	3.4	
RTC460	355	2800	200	765	220	340	122	258	23.4	3.9	
RTC580	490	4250	228	965	180	260	193	408	31.4	5.2	
RTC650	1040	8000	490	1800	150	240	224	473	33.8	5.6	
RTC850	1000	8650	455	1730	120	180	286	604	40.3	6.7	
RTC950	1290	11400	530	2040	110	160	320	676	45.1	7.5	
Designation examples:						Standard design			Enhanced-precision design		
						RTC325			RTC325.T52E		

AXIAL-RADIAL CYLINDRICAL ROLLER BEARINGS

RTC

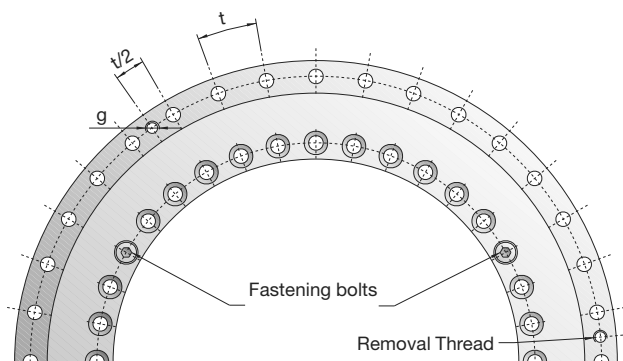

Radial Rigidity S_r max.	Tilting Rigidity		Friction Torque M_r Nm	Fastening Bolts Thread Nominal Diameter	Tightening Torque Bolt Quality			Weight kg	Bearing Code
	S_k kNm/mrad	S_{k1}			8.8	10.9	12.9		
4.5	10	1.6	1	M5	6	8.5	10	2.0	RTC080
4.2	37	6	4	M5	6	8.5	10	4.0	RTC100
6.5	65	11	5	M6	10	14	17	5.0	RTC120
7.7	83	14	7	M6	10	14	17	5.8	RTC150
7.2	125	21	9	M6	10	14	17	8.0	RTC180
6.7	160	27	11	M6	10	14	17	9.3	RTC200
8.6	320	53	16	M8	25	34	40	18	RTC260
7.9	630	105	27	M8	25	34	40	25	RTC325
13.6	1100	185	42	M8	25	34	40	33	RTC395
15.7	1700	285	55	M8	25	34	40	48	RTC460
19.7	3400	570	133	M10	50	70	85	84	RTC580
20.3	5000	830	183	M12	85	120	140	169	RTC650
18.9	9600	1600	295	M16	200	290	350	236	RTC850
20.9	12500	2100	366	M16	200	290	350	270	RTC950

Enhanced-precision design, reduced axial preload
RTC325.T52EA

See Bearing Code, page 198

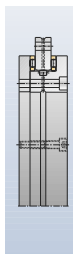

LIFE CALCULATION FOR SUPER PRECISION BEARINGS

Life Calculation for Super Precision Bearings

Super precision bearings must locate machinery components with high accuracy and support loads at up to very high speeds. They are predominantly selected for their

- accuracy
- rigidity
- running behaviour.

These demands can be met over an expected life span only if no bearing wear occurs. This is dependent upon the generation of a supportive hydrodynamic lubricant film in the rolling contact area. Under these circumstances rolling bearings achieve ultimate life in a variety of applications. From the load point of view, the stress occurring in the contact points as well as the bearing kinematics are of decisive influence on bearing service life. Therefore the traditional design in keeping with DIN ISO 281 has proved inexpedient while the modified life calculation

comes closer to field experience. Yet especially for high-performance units it is better to determine individual bearing arrangements with the help of special calculation programs.

Bearing Load

Dynamic Equivalent Load P

For dynamically loaded bearings, the loads are combined into a dynamic equivalent load P. This is the constant load derived from

- combined load (radial and axial)
 - temporarily alternating loads
- to give the same calculated life as the actually acting combined load.

For bearings that can accommodate radial and axial load components, the equivalent load is calculated using the equation

$$P = X \cdot F_r + Y \cdot F_a$$

The factors X and Y are derived from the ratio of F_a/F_r compared to the bearing specific factor e.

Spindle Bearings

Contact Angle $\alpha = 15^\circ$

$$F_a/F_r \leq e$$

$$X = 1, Y = 0.$$

$$F_a/F_r > e \text{ (Tables 14 and 15)}$$

$$P = 0.44 \cdot F_r + Y \cdot F_a$$

Contact Angle $\alpha = 25^\circ$

With bearings of $\alpha = 25^\circ$, the contact angle changes very little even under axial load and therefore the axial factor Y is taken as a constant.

$$F_a/F_r \leq 0.68$$

$$P = F_r$$

$$F_a/F_r > 0.68$$

$$P = 0.41 \cdot F_r + 0.87 \cdot F_a$$

$\frac{f_0 \cdot F_a}{i \cdot C_0}$	Spindle Bearings		
	$\alpha = 15^\circ$ e	X	Y
0.3	0.4	0.44	1.4
0.5	0.43	0.44	1.31
0.9	0.45	0.44	1.23
1.6	0.48	0.44	1.16
3	0.52	0.44	1.08
6	0.56	0.44	1

i = number of bearings that accommodate the axial load

14: Radial and axial factors

Bore Reference Number	Factor f_0					
	Bearing Series					
	B718C	B719C	B70C	B72C	HS719C	HS70C
		HCB719C	HCB70C	HCB72C	HC719C	HC70C
		XCB719C	XCB70C		XC719C	XC70C
00	14.9	14.2	12.6	12.3	15.3	15.5
01	15.4	14.7	13.2	12.9	15.7	15.5
02	15.9	14.5	14.1	13.6	15.8	15.8
03	16.2	14.8	14.3	13.9	16	15.9
04	15.9	14.2	14.3	13.8	16.2	16.1
05	16.4	14.9	14.9	14.4	16.5	16.2
06	16.4	15.4	15.1	14.3	16.4	16.3
07	16.2	15.9	15.4	14.6	16.4	16.5
08	16	15.5	15.7	14.2	16.2	16.5
09	16.2	15.8	15.5	14.2	16.3	16.5
10	16	16	15.7	14.4	16.2	16.5
11	16.2	16	15.5	14.5	16.1	16.5
12	16.3	16.2	15.6	14.4	16.2	16.4
13	16.1	16.4	15.9	14.5	16.1	16.4
14	16	16.2	15.6	14.6	16.1	16.4
15	16	16.3	15.8	14.8	16.1	16.3
16	15.9	16.4	15.7	14.8	16.1	16.3
17	16.1	16.3	15.9	14.9	16	16.3
18	16.1	16.4	15.7	14.8	16	16.3
19	16	16.4	15.9	14.9	15.9	16.3
20	15.9	16.5	16	14.5	16	16.2
21	15.9	16.4	15.9	14.5	15.9	16.3
22	16.1	16.4	15.8	14.5	16	16.2
24	16	16.4	16	14.9	15.9	16.3
26	16.1	16.4	15.9	14.7	15.9	16.2
28	16	16.4	16	15		
30	16.1	16.3	16	15.3		
32	16	16.4	16.2	15.3		
34	16.1	16.5	15.9	15.4		
36	16	16.4	15.7	15.4		
38	16	16.4	15.9	15.2		
40	15.9	16.2	15.8	15.4		
44	15.8	16.4	15.7	15.3		
48	15.9	16.5	15.9			

15: Factor f_0 for spindle bearings with a contact angle of $\alpha = 15^\circ$

FD Bearings and Cylindrical Roller Bearings

For FD bearings and cylindrical roller bearings in super precision design

$$P = F_r$$

Angular Contact Thrust Ball Bearings

Angular contact thrust ball bearings are not suited for radial load $F_r > 0.47 \cdot F_a$. Small radial load components are not taken into consideration when calculating the equivalent load.

$$P = F_a$$

RTC Bearings

The dimensions of RTC bearings are directly oriented to their main applications in machine tools. For special applications it is advisable to determine the loads with suitable computer programs, for instance *SpiCaS 2000*.

In general

$$P = F_a \quad \text{for the axial roller row}$$

$$P = F_r \quad \text{for the radial roller row}$$

LIFE CALCULATION FOR SUPER PRECISION BEARINGS

Equivalent Load with Varying Loads and Speeds

For bearing arrangements that are subject to varying loads and speeds, the equivalent load is calculated from the individual loads and speeds with their corresponding percentage of time:

$$P = \sqrt[3]{P_1^3 \cdot \frac{n_1}{n_m} \cdot \frac{q_1}{100} + P_2^3 \cdot \frac{n_2}{n_m} \cdot \frac{q_2}{100} + \dots} \text{ [kN]}$$

and the mean speed n_m from:

$$n_m = n_1 \cdot \frac{q_1}{100} + n_2 \cdot \frac{q_2}{100} + \dots \text{ [min}^{-1}\text{]}$$

Static Equivalent Load P_0

For super precision bearings the static load, i.e. loading in the absence of ring rotation, is rarely checked. The stress index f_s as a measure of the static load is obtained from

$$f_s = C_0 / P_0$$

f_s = static stress index

C_0 = static load rating [kN]

P_0 = static equivalent load [kN]

For the modified life calculation, factor f_{s^*} is also obtained from the following equations, however using the dynamic loads.

Spindle Bearings

Contact angle $\alpha = 15^\circ$

$$P_0 = F_r \text{ [kN]}$$

for $F_a/F_r \leq 1.09$

$$P_0 = 0.5 \cdot F_r + 0.46 \cdot F_a \text{ [kN]}$$

for $F_a/F_r > 1.09$

Contact angle $\alpha = 25^\circ$

$$P_0 = F_r \text{ [kN]}$$

for $F_a/F_r \leq 1.31$

$$P_0 = 0.5 \cdot F_r + 0.38 \cdot F_a \text{ [kN]}$$

for $F_a/F_r > 1.31$

Where there are several bearings, the load is calculated for the individual bearing.

An axial load is evenly distributed on the loaded bearings.

In order to maintain the accuracy of the bearings, the static stress index should be higher than 3.0.

Only with an extremely short-term and centric axial load (tool ejection force), $f_s \geq 1$ is admissible for hybrid bearings.

Angular Contact Thrust Ball Bearings

$$P_0 = 3.98 \cdot F_r + F_a$$

The static stress index should be higher than 2.5.

Double Direction Angular Contact Thrust Ball Bearings

$$P_0 = F_a$$

The static stress index should be higher than 2.5.

FD Bearings and Cylindrical Roller Bearings

$$P_0 = F_r$$

The static stress index should be higher than 3.0.

RTC Bearings

$$P = F_a \quad \text{for the axial roller row}$$

$$P = F_r \quad \text{for the radial roller row}$$

The static stress index should be higher than 3.0.

Modified Life Calculation L_{hna}

Stress Index f_{s^*}

The stress index is a measure for anticipating whether a bearing can be fail-safe in a specific application. Precise individual calculation can be made of the load distribution and the Hertzian contact pressure as well as the comparison with known limits. Provided that the further conditions $\kappa \geq 2$ and $V = 0.3$ are met, a modified life calculation is not required.

$$f_{s^*} = C_0/P_0^*$$

P_0^* can be calculated using the equations for the static equivalent load, however using the same dynamic loads as for the equivalent load.

Bearing Component	Temperature Limits
Cage	100 °C
Seal	100 °C
Lubricant	see chapter "Lubrication"
Bearing rings	150 °C

16: Temperature limits of bearing components

Modified Life Calculation

FAG has developed an extended life calculation which considers the operating and environmental influences to a substantially larger degree than the standard calculation. The calculated modified life does not necessarily correspond to the bearing service life as it may be reduced by the service life of the lubricant. In this case the life of the lubricant (see Diagram 26) tallies with the bearing life:

$$L_{hna} = a_1 \cdot a_{23} \cdot L_{h10}$$

Factor a_1

Bearing failures due to material fatigue are subject to statistical laws. The failure probability is taken into consideration by factor a_1 . Factor $a_1 = 1$ corresponds to a 10-percent failure probability and is usually used for the modified life calculation.

Factor a_{23}

Factor a_{23} considers the influences of material, bearing type, loading, lubrication and cleanliness. Super precision bearings are dimensionally stable up to 150 °C. Up to this value, the influence of temperature on the material properties need not be taken into account. Temperature limits of cage, sealing and lubricant have to be observed (see Table 16). For applications of super precision bearings at higher temperatures, please consult FAG. For the effects of load the stress index f_{s^*} should be ascertained. If $f_{s^*} > 8$, the bearing can be fail-safe.

Endurance Strength

The maximum Hertzian contact pressure is 2000 MPa with point load for 100Cr6 material and 2500 MPa for Cronidur 30 material; for cylindrical roller bearings the maximum linecontact pressure is 1500 Mpa.

LIFE CALCULATION FOR SUPER PRECISION BEARINGS

Modified Life Calculation L_{hna}

Bearing Type

Factor K_1 (Diagram 19) for the bearing type considers the kinematic properties of different bearing types, curves a and b.

Lubrication

The condition of the lubricant film is taken into account by the value $\kappa = v/v_1$ as a measure of lubricant film thickness and K_2 as a measure of the effectiveness of additives. The rated viscosity v_1 is a function of bearing size and speed and can be ascertained from Diagram 17. v_1 is compared to the actually existing viscosity v at operating temperature in Diagram 18. For greases the viscosity of the base oil is used.

When using adequate quantities of an appropriate grease for lubrication, the same K_2 values can be assumed as for an oil with a suitable additive. If the suitability of a lubricating grease is not exactly known, an a_{23II} factor from the lower limit of zone II ($K = 6$) should be chosen (Diagram 20) to be on the safe side. Obtaining $K = K_1 + K_2$ from Diagram 19 and κ , the a_{23II} factor is determined from Diagram 20.

K_2 is used in accordance with the f_{s^*} index for additive and non-additive lubricants whose effectiveness in rolling bearings has not been tested. $K_2 = 0$ for lubricants with additives for which corresponding evidence is available.

Where $K = 0$ to 6 , a_{23II} is found on one of the curves in zone II.

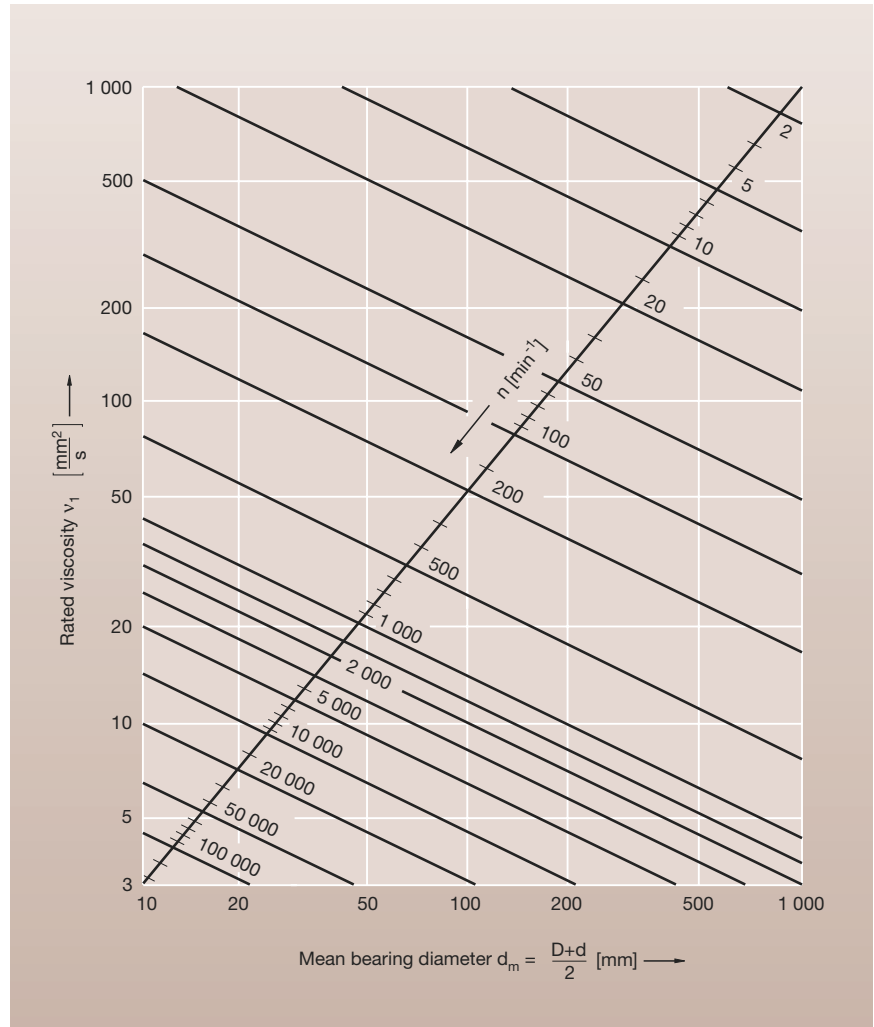

17: Rated viscosity v_1

18: V-T diagram

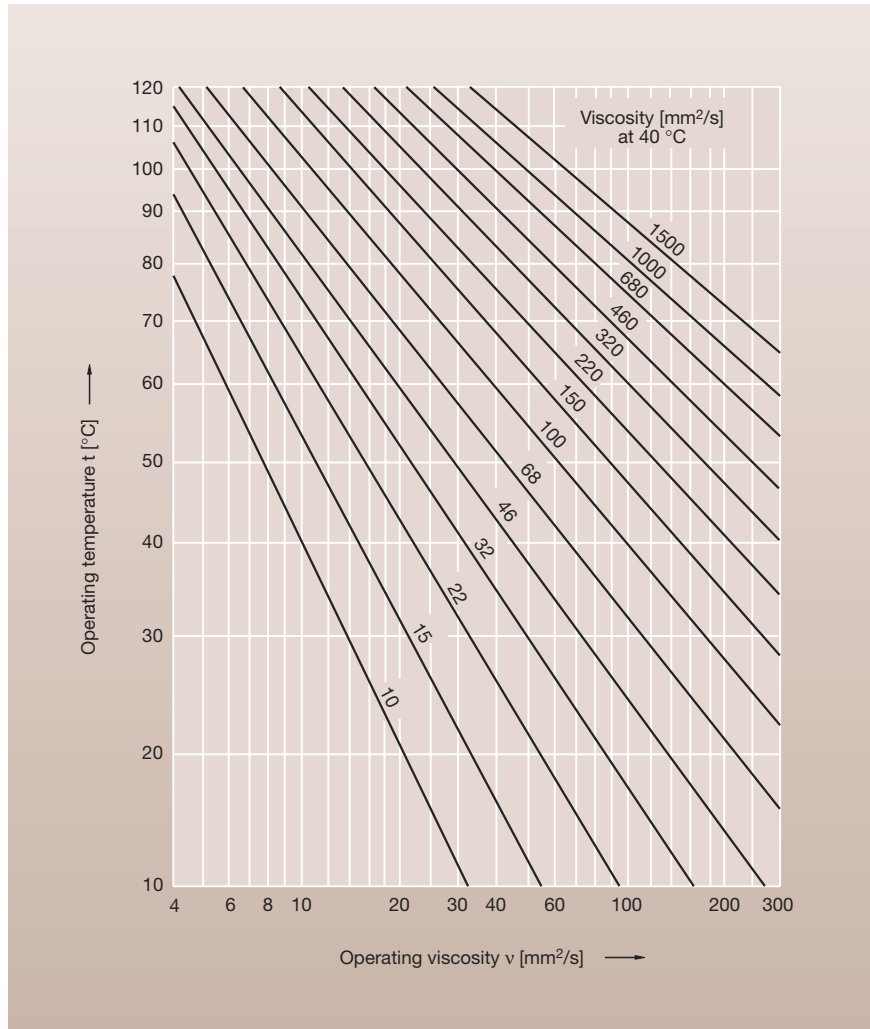

19: K_1 depending on index f_{s^*} and the bearing type

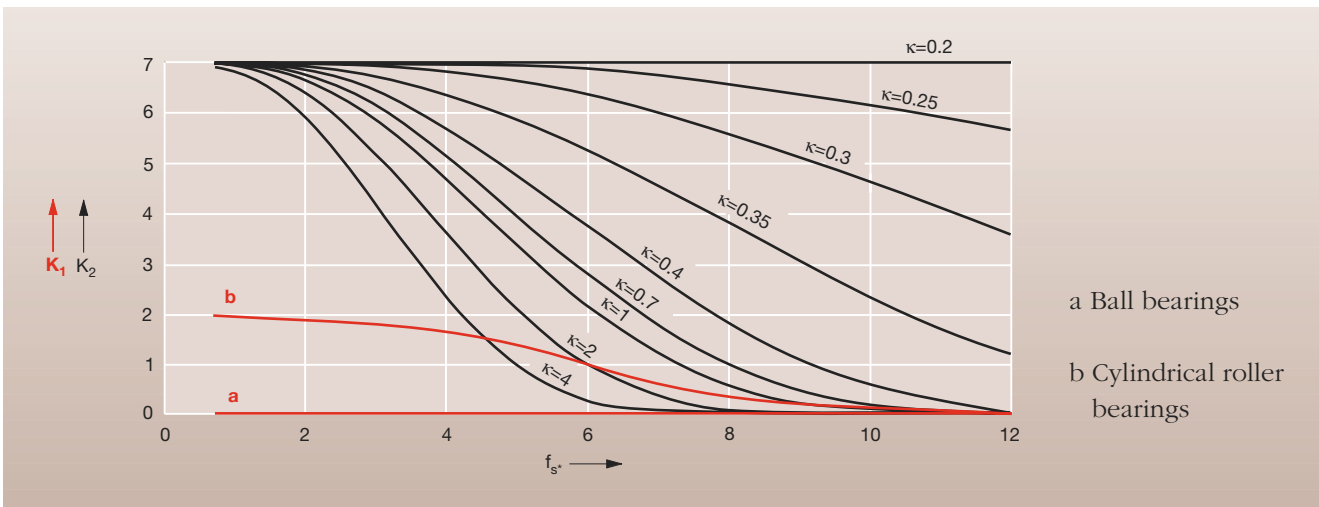

LIFE CALCULATION FOR SUPER PRECISION BEARINGS

Modified Life Calculation L_{hna}

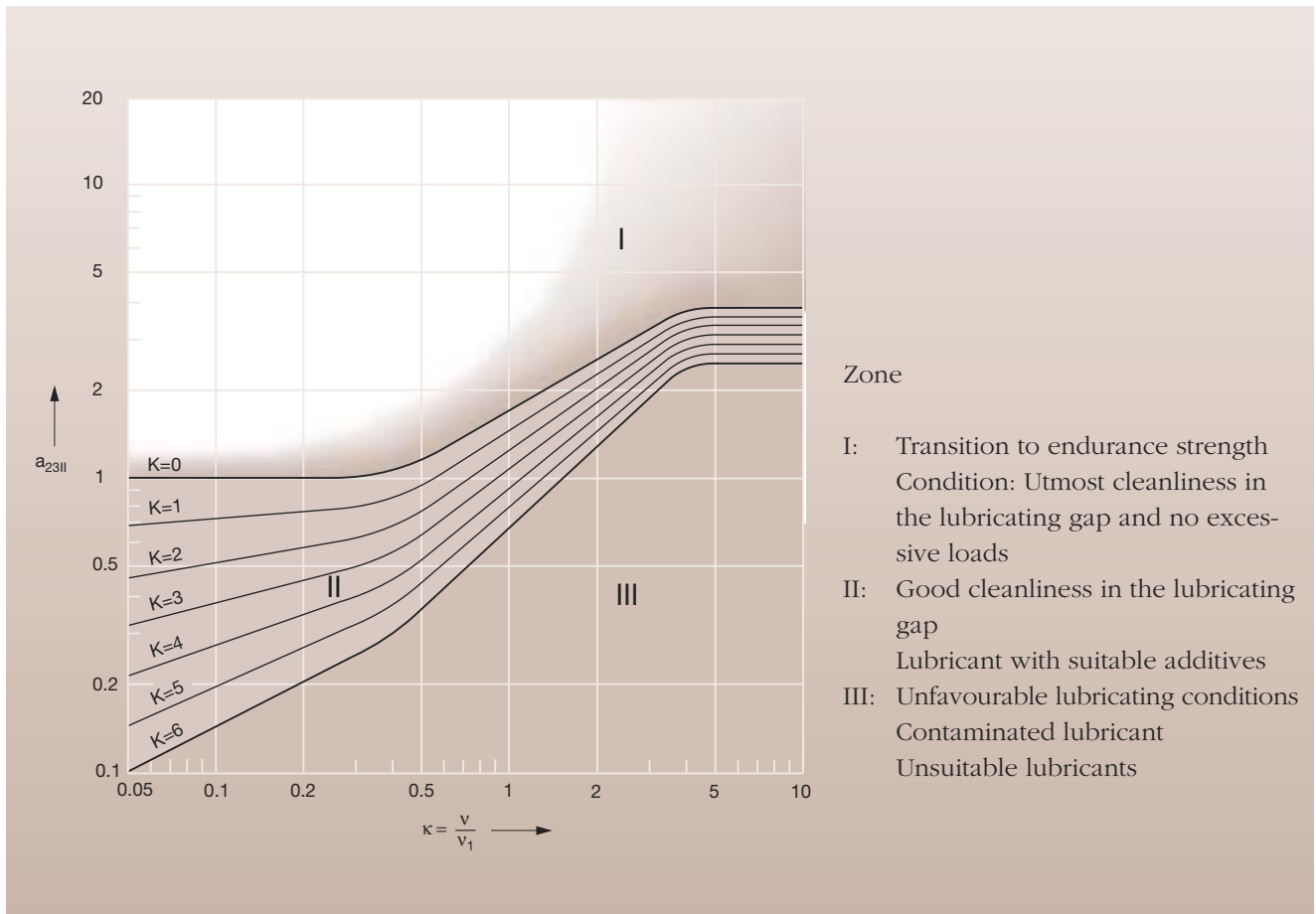

20: Basic a_{23II} factor for determining the a_{23} factor
 v operating viscosity of lubricant; v_1 rated viscosity

Where $K > 6$, the a_{23} factor must be expected to be in zone III.

In such a case, a smaller K value and thus zone II should be aimed at by improving the conditions.

Cleanliness

The cleanliness in the contact area plays a very important role for precision bearings as

- the relative influence on life is very large with the generally lightly loaded bearings
- contamination greatly promotes wear.

It is therefore necessary to specify a cleanliness level that permits contamination less than specified

by factor $V = 1$. Reference values for the V factor have been adopted from the hydraulic field and can be obtained from Table 21.

The cleanliness factor s can be taken from Diagram 22. a_{23} is derived from the equation

$$a_{23} = a_{23II} \cdot s.$$

In practice, utmost cleanliness is ensured when the bearings are greased and protected with seals

(D-d)/2 mm	V ¹⁾	Point Contact			Line Contact		
		required oil cleanliness class according to ISO 4406	required filtration ratio according to ISO 4572	maximum ²⁾ size of cycled particles µm	required oil cleanliness class according to ISO 4406	required filtration ratio according to ISO 4572	maximum ²⁾ size of cycled particles µm
≤ 12.5	0.3	11/8	$\beta_3 \geq 200$	10	12/9	$\beta_3 \geq 200$	20
	0.5	12/9	$\beta_3 \geq 200$		13/10	$\beta_3 \geq 75$	
	1	14/11	$\beta_6 \geq 75$	30	15/12	$\beta_6 \geq 75$	60
> 12.5 ... 20	0.3	12/9	$\beta_3 \geq 200$	15	13/10	$\beta_3 \geq 75$	25
	0.5	13/10	$\beta_3 \geq 75$		14/11	$\beta_6 \geq 75$	
	1	15/12	$\beta_6 \geq 75$	45	16/13	$\beta_{12} \geq 75$	75
> 20 ... 35	0.3	13/10	$\beta_3 \geq 75$	25	14/11	$\beta_6 \geq 75$	40
	0.5	14/11	$\beta_6 \geq 75$		15/12	$\beta_6 \geq 75$	
	1	16/13	$\beta_{12} \geq 75$	75	17/14	$\beta_{12} \geq 75$	120
> 35	0.3	14/11	$\beta_6 \geq 75$	40	14/11	$\beta_6 \geq 75$	75
	0.5	15/12	$\beta_6 \geq 75$		15/12	$\beta_{12} \geq 75$	
	1	17/14	$\beta_{12} \geq 75$	120	18/14	$\beta_{25} \geq 75$	200

The oil cleanliness class as a measure of the probability of life-reducing particles being cycled in a bearing can be determined by means of oil samples, e.g. through filter manufacturers and institutes. The cleanliness class will be reached if the total oil quantity flows through the filter within a few minutes. To safely ensure a high degree of cleanliness, flushing is required prior to bearing operation.

E.g., a filtration ratio of $\beta_3 \geq 200$ (ISO 4572) means that only 1 out of 200 particles $\geq 3 \mu\text{m}$ will pass the filter in a so-called multi-pass test. Filters coarser than $\beta_{25} \geq 75$ should not be used due to the detrimental effects on the other components within the oil circulation system.

^{1,2)} Contamination factors V apply when no larger particles of a hardness > 50 HRC are cycled in the highly loaded contact zone.

21: Guide values for contamination factor V

by the manufacturer. The life of fail-safe types is usually limited by the service life of the lubricant (see Grease Service Life, page 138).

The modified life calculation has replaced the traditional calculation according to DIN ISO 281 in the field of super precision applica-

tions. To enable the comparison with earlier bearing arrangements, the equation is given below. The determination of the relevant factors has been explained in the preceding paragraphs.

$$L_{h10} = \left(\frac{C}{P}\right)^p \cdot \frac{10^6}{60 \cdot n}$$

L_{h10} = Life [h] for 10% failure probability

C = Dynamic load rating [kN]

P = Dynamic equivalent load [kN]

n = Speed [min^{-1}]

p = 3 for ball bearings

p = 10/3 for roller bearings

LIFE CALCULATION FOR SUPER PRECISION BEARINGS

Modified Life Calculation L_{hna} • Grease Service Life

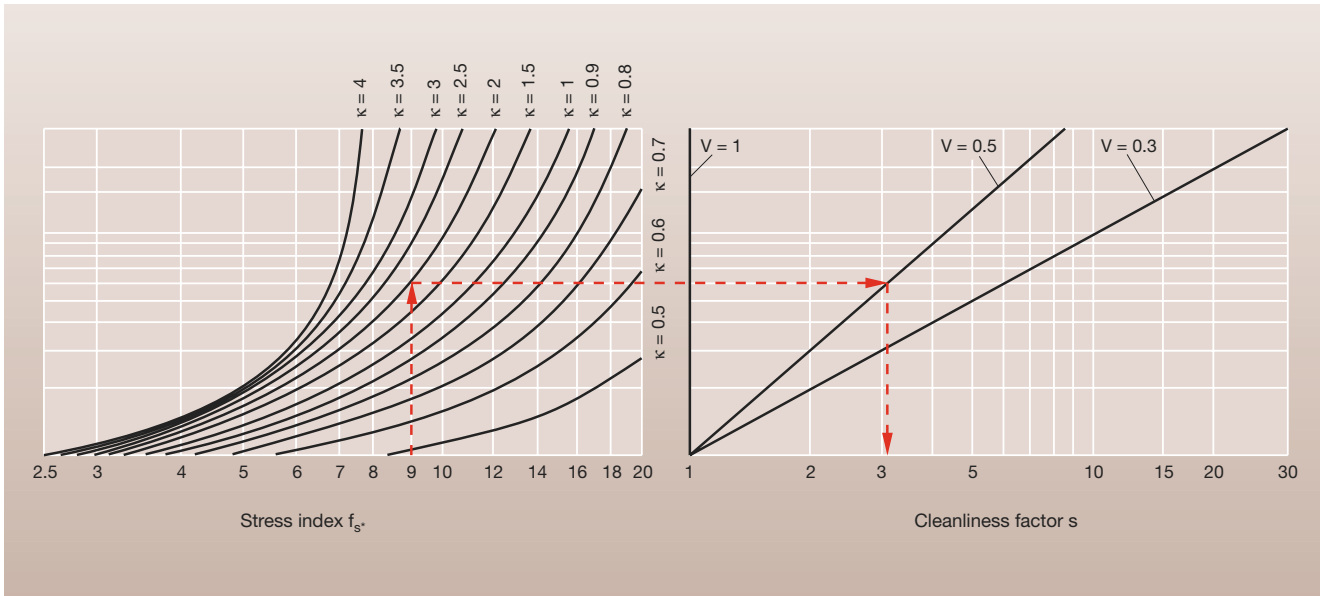

22: Diagram for the determination of cleanliness factor s
Diagram for improved ($V = 0.5$) to utmost ($V = 0.3$) cleanliness

Grease Service Life

The grease service life is the time during which proper bearing function is sustained by a particular quantity of grease. It depends on

- grease quantity
- grease type
- bearing type
- speed
- temperature
- installation conditions.

In many applications of super precision bearings, the grease service life is the decisive factor for the life of the bearing arrangement in comparison to the bearing fatigue life. The grease life can be obtained from Diagram 26.

LUBRICATION

Grease Lubrication

Lubrication

A decisive factor for

- adequate bearing service life
- wear-free operation
- low vibration level

is a lubricating film that separates the rolling elements in the contact zone.

In order to achieve this

- the constant presence of a lubricant at all contact points must be ensured

and

- a lubricant with appropriate properties has to be selected.

Lubricant Viscosity

The rated viscosity of a lubricant (see Life Calculation) can be ascertained from Diagram 17. For successful operation a viscosity at an operating temperature of at least double that of the rated viscosity should be aimed at.

$$\kappa = \nu / \nu_1 \geq 2$$

Grease Lubrication

Super precision bearings are predominantly grease-lubricated. The essential advantages of grease lubrication include

- low friction
- for-life lubrication
- simple designs
- low system costs.

Minimum oil quantity lubrication is used when the spindle speed is too high for grease lubrication.

The development in the grease and bearing field has led to an enormous performance increase in particular with respect to attainable speeds. Speed indices $d_m \cdot n$ of up to 2 000 000 mm/min are attainable today.

The use of spindle bearings supplied with initial grease filling and seals brings further advantages, for instance utmost cleanliness as the bearing interior is protected against contamination. In addition, handling during mounting is easier.

Suitable greases for super precision bearings are listed in Table 23. FAG grease Arcanol L75 is a high-performance grease for a wide range of high-speed spindle bearing applications up to constant temperatures of 80 °C, measured at the outer ring. Since the temperatures in motor spindles will hardly reach 80 °C due to the standard liquid cooling, FAG grease Arcanol L75 can be called the spindle bearing standard grease. It replaces the former FAG standard grease Arcanol L74. FAG grease Arcanol

FAG Grease Arcanol	L75	L210	L55
Designation DIN 51 502	KE3K-50	KHC3P-40	KP2N-40
Thickener	polyurea	polyurea	lithium
Base oil	PAO/ester	PAO/ester	mineral oil + ester
Base oil viscosity mm ² /s at 40 °C	22	65	85
at 100 °C	5	10	12.5
Consistency class	3	3	2
Operating temperature without service life reduction (°C)	up to 80	up to 100	up to 70
Used as	high-speed grease		high-pressure grease
Standard grease in	HSS,HCS,XCS B,HC...2RSD		7602..2RS.TVP 7603..2RS.TVP RTC
Specific weight (approx.) g/cm ³	0.92	0.88	0.9

23: FAG rolling bearing greases for super precision bearings

LUBRICATION

Grease Lubrication

L210 is another high-speed grease. Thanks to its higher base oil viscosity it is used at constant temperatures higher than 80 up to approx. 100 °C.

FAG lubricating grease Arcanol L55 is a high-pressure grease that is well-proven in shaft end bearing applications for ball screw drives, axial-radial cylindrical roller bearings (RTC) and also in tailstock centre bearing arrangements.

Grease Quantity

Each bearing type requires different grease quantities. The recommendations in Tables 24 and 25 are adjusted to the bearing volume that is not disturbed by rotating components.

Bearing Code FAG	Grease Quantity cm ³	Bearing Code FAG	Grease Quantity cm ³
7602012TVP	0.42	7602060TVP	10.90
		BSB060120T	8.45
7602015TVP	0.66	7603060TVP	23.40
7602017TVP	0.88	7602065TVP	13.00
		7603065TVP	28.40
7602020TVP	1.58		
BSB020047T	1.84	7602070TVP	14.80
7603020TVP	1.86	7603070TVP	33.70
7602025TVP	2.15	7602075TVP	17.20
7603025TVP	3.45	BSB075110T	5.45
BSB025062T	2.55	7603075TVP	41.40
7602030TVP	2.95	7602080TVP	19.70
BSB030062T	2.55	7603080TVP	48.90
7603030TVP	5.05		
		7602085TVP	24.70
7602035TVP	4.10	7603085TVP	55.30
BSB035072T	3.10		
7603035TVP	6.60	7602090TVP	30.10
		7603090TVP	64.70
BSB040072T	3.10		
7602040TVP	4.95	7602095TVP	36.20
BSB040090T	6.80	7603095TVP	75.10
7603040TVP	9.20		
		7602100TVP	41.40
BSB045075T	3.35	BSB100150T	16.60
7602045TVP	5.95	7603100TVP	88.40
BSB045100T	6.95		
7603045TVP	12.30	7602110TVP	57.90
		7603110TVP	108.00
7602050TVP	7.20		
BSB050100T	6.95	7602120TVP	67.60
7603050TVP	16.00		
		7602130TVP	72.70
BSB055090T	4.20		
7602055TVP	8.70		
BSB055120T	8.15		
7603055TVP	19.90		

24: Grease quantities for single row angular contact thrust ball bearings in cm³

25: Recommended grease quantities in cm³ (opposite page)

Bore/ Bore Reference Number	Grease Quantity									
	Bearing Series									
	HS719	HS70	B719	B70	B72	N10	N19	NN30	NNU49	2344
	HC719	HC70	HCB719	HCB70	HCB72	HCN10	HCN19			2347
	XC719	XC70	XCB719	XCB70	XCB72					
	cm ³									
6		0.12		0.04						
7		0.13		0.06						
8		0.17		0.11						
9		0.21		0.10						
00	0.17	0.26	0.09	0.17	0.26					
01	0.18	0.28	0.10	0.21	0.36					
02	0.28	0.46	0.17	0.32	0.48					
03	0.32	0.58	0.17	0.42	0.68					
04	0.58	0.98	0.36	0.76	1.12					
05	0.68	1.14	0.40	0.86	1.44					
06	0.92	1.72	0.42	1.12	2.10			1.56		3.90
07	1.18	2.20	0.64	1.74	3.00			1.78		5.00
08	1.62	2.60	1.36	2.35	3.80			2.20		6.10
09	2.10	3.65	1.60	3.00	4.55	1.34		2.90		7.80
10	2.35	4.00	1.74	3.30	5.45	1.56		3.10		8.35
11	3.40	5.95	2.20	4.60	6.50	2.20		4.45		12.20
12	3.60	6.40	2.50	4.95	8.00	2.45		4.90		12.20
13	3.90	6.80	2.65	5.30	9.35	2.55		5.10		13.30
14	5.80	9.20	4.35	7.10	10.80	3.55		7.20		17.80
15	6.10	9.70	4.60	7.50	12.90	3.90		7.80		18.90
16	7.00	12.80	4.90	9.65	12.30	5.55		10.60		25.60
17	8.55	13.40	6.80	10.30	18.30	5.55		11.10		27.80
18	9.40	17.70	7.10	13.30	19.10	7.20		14.40		38.90
19	9.85	18.40	7.45	13.90	26.10	7.20		14.40		38.90
20	12.80	19.20	9.70	14.60	27.20	7.20	5.55	14.40	5.55	44.40
21	13.30	24.60	10.10	15.00	36.30	10.00	5.55	20.00	5.55	61.10
22	14.70	28.20	10.40	21.90	43.90	13.30	5.55	26.70	5.55	61.10
24	17.90	30.30	14.20	23.60	38.80	14.40	10.00	30.00	10.00	66.70
26	24.00	43.70	18.10	36.10	41.90		11.10	36.70	11.10	105.60
28	25.60	46.30	19.30	38.30	58.60		12.20	40.00	12.20	116.70
30	37.80	57.10	28.40	44.70	81.30		21.10	50.00	21.10	138.90
32	39.90	69.70	30.00	58.20	102.90		22.20	61.10	22.20	172.20
34			31.70	65.30	120.40			83.30	23.30	227.80
36			47.40	94.90	125.70			111.10	30.00	316.70
38			50.00	99.10	155.40			116.70	33.30	311.10
40			70.60	118.30	187.80			150.00	44.40	411.10
44			68.30	172.60	250.10			200.00	52.20	522.20
48			73.70	185.30				222.20	50.00	622.20
52			118.20	267.00				311.10	94.40	833.30
56			126.00	283.90				344.40	100.00	850.00

Spindle bearings of series HS, HC and XC are available in greased and sealed designs; designations HSS, HCS and XCS.
 Spindle bearings of the B series are also available in a greased and sealed version; supplement .2RSD, see bearing tables.

LUBRICATION

Grease Lubrication

Grease Service Life

The grease service life is the time over which proper bearing function is sustained by a particular quantity of grease. It depends on

- grease quantity
- grease type
- bearing type
- speed
- temperature
- installation, operating and environmental conditions.

In many applications of super precision bearings, the grease service life is the decisive factor for the life of the bearing arrangement in comparison to the bearing fatigue life. It can be determined from Diagram 26 which applies to high-

speed greases. Unfavourable operating and environmental conditions, including humidity, vibration or air flow through the bearings, have to be taken in consideration if applicable.

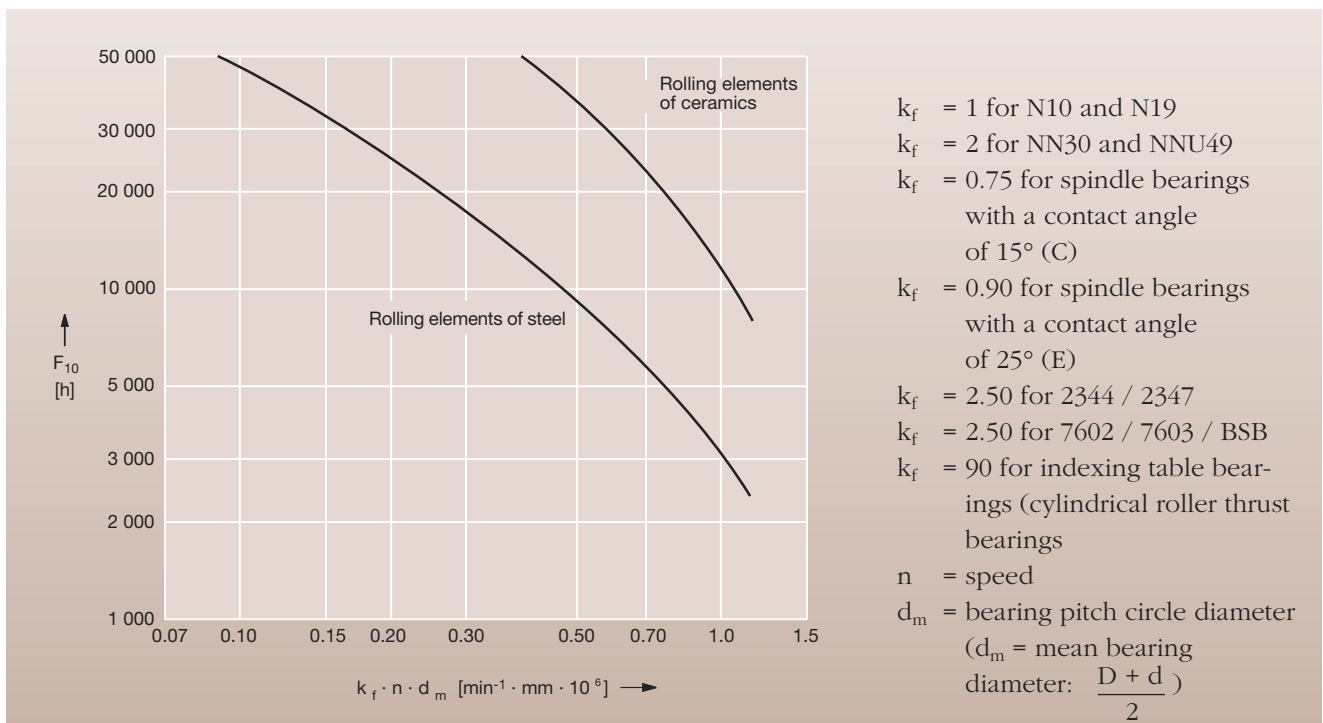

26: Grease Service Life F_{10}

Grease Distribution Run

The correct initial operation of grease-lubricated bearing arrangements has a great influence on the performance and service life of a bearing arrangement. A start-stop operation is recommended for grease distribution. This prevents excessively high damaging temperatures in the contact area. During the stop phase a temperature balance takes place between the individual bearing components so that damaging preloading conditions do not occur. It is recommended

that the temperature development during the grease distribution run and the following continuous operation be monitored by means of a temperature sensor located as close to the bearing outer ring as possible. A progressive rise in temperature that occurs for instance under conditions of excessive preloading, must be avoided at all events. The grease distribution is complete when a stable bearing temperature has been reached. For maximum speeds the run-in procedure should be carried out at half speed initially, followed by a 0.75

fold speed prior to operation at maximum speed. Illustration 27 shows recommendations for grease distribution runs of open and sealed spindle bearings. The grease quantity, Table 25, and the grease distribution run, Illustration 27, are available as shrink-wrapped cards in DIN A5 format for use in workshops.

The run-in procedure consists of several cycles of a start-stop operation with differing speeds and operating periods, the standstill periods after each run being particularly important. The required number of cycles may differ depending on bearing size, bearing number, maximum speeds and bearing environment.

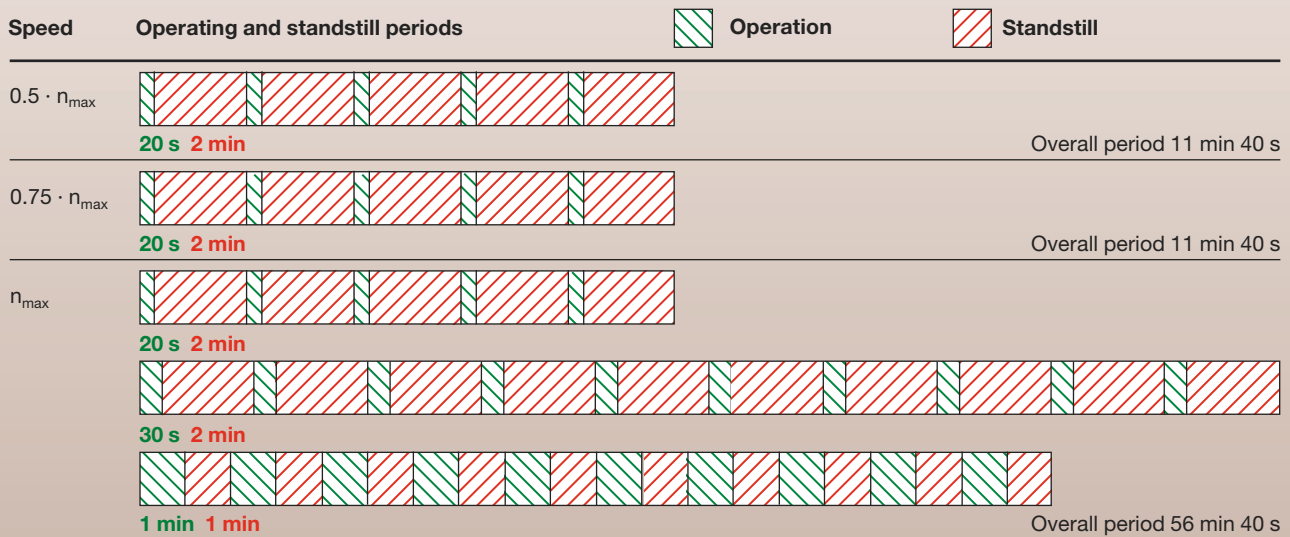

Further cycles with extended operating periods and shorter standstill periods should be carried out until a steady-state temperature has been reached.

27: Recommendations for grease distribution runs of open and sealed spindle bearings

LUBRICATION

Oil Lubrication

Minimal Oil Quantity Lubrication

FAG spindle bearings require very little oil. An amount of approx. $100 \text{ mm}^3/\text{h}$ is sufficient, provided that all rolling and sliding contact areas are wetted with oil. Minimal oil quantity lubrication keeps frictional losses to a minimum.

It is employed when the spindle speed is beyond the range of grease lubrication. The standard method today is oil-air lubrication. Speeds attainable with minimal oil quantity lubrication are listed in the dimensional tables of part I. Oils according to the designation ISO VG 68 + EP, meaning a nominal viscosity of $68 \text{ mm}^2/\text{s}$ at $40 \text{ }^\circ\text{C}$

and Extreme Pressure additives, have proven suitable. Guide values for the oil quantity required for minimal oil lubrication are shown in Diagram 28. Specific flow conditions in the bearing arrangement can substantially influence the required oil quantity.

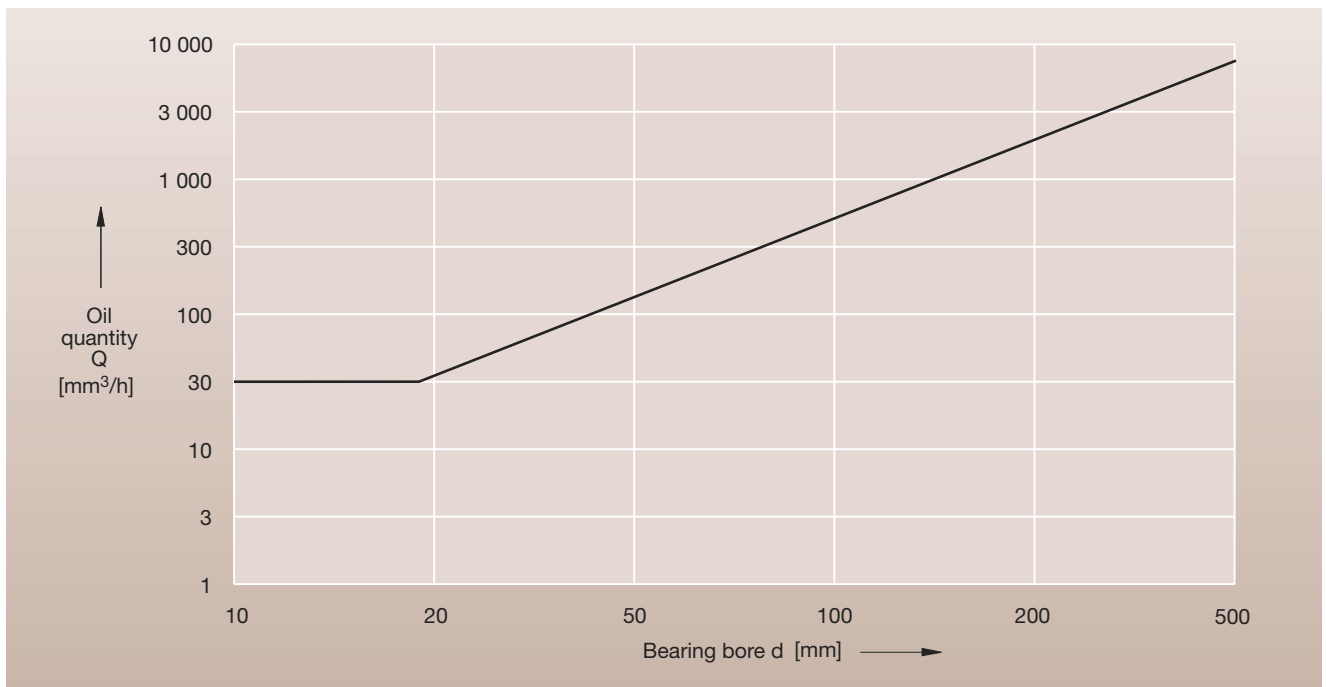

28: Oil quantity required for oil-air lubrication of FAG spindle bearings

Recommendations for Oil-Air Lubrication

for B, HCB, XCB, HS, HC, XC spindle bearings, also in Direct-Lube design DLR:

Oil cleanliness class:	13/10 (ISO 4406)
Air cleanliness:	Particle size 0.01 μm max.
Air dryness:	Dew point at + 2 °C
Air inlet tube pressure:	approx. 3 bars
Nozzle \varnothing :	0.5 to 1 mm.
Number of nozzles:	Extra nozzles for each bearing, one nozzle per every 150 mm of pitch circle circumference
Nozzle design:	Inlet tube parallel to spindle rotational axis between inner ring lip and cage bore
Injection pitch circle \varnothing :	See Bearing Tables (E_{tk}) or <i>SpiCaS</i> 2000.
Inlet tubes:	Inner diameter 2 to 2.5 mm, flexible and transparent tubing of synthetic material; thus the oil stream at the inner tube wall is visible.
Length:	At least 1 m, optimum 4 m, up to approx. 10 m. Spirals with some five windings, centre axis horizontal or up to 30° inclined, no closer than approx. 500 mm in front of the nozzle. When lubrication is interrupted, the oil will collect in the windings at the bottom and soon be available again when operation is resumed. Thus a short lead time becomes possible for spindle starts.
Oil outlets:	At both sides of each bearing; oil collection can cause high temperature running. For vertical spindles outlet ducts should be provided underneath each bearing so that the bearings below will not be oil-spilt. Outlet ducts if possible $\geq \varnothing$ 5 mm. Connect all outlet ducts from all bearings of one spindle for pressure balance reasons.

Oil-Air Lubricating Devices

Normal oil quantities per injection cycle:	3, 5, 10, 30, 60, 100 mm^3
Normal injection cycles per hour:	6 to 10

Further data can be obtained from manufacturers of oil-air lubricating devices.

TOLERANCES FOR SUPER PRECISION BEARINGS

Definitions

Tolerances for Super Precision Bearings

The tolerances for precision bearings are standardised according to DIN 620. Definitions for dimensions and accuracies are laid down in DIN ISO 1132.

To ensure the full exploitation of the bearing performance capability and a high machining accuracy, the dimensional, form and running accuracies of FAG super precision bearings are manufactured to very close tolerances as standard.

The tolerances of form and position correspond to the accuracy standard

- P2 for all super precision spindle bearings and Floating Displacement bearings (FD)
- P4 for all for all precision cylindrical roller bearings and angular contact thrust ball bearings.

Precision cylindrical roller bearings can be supplied in the higher precision class UP upon request.

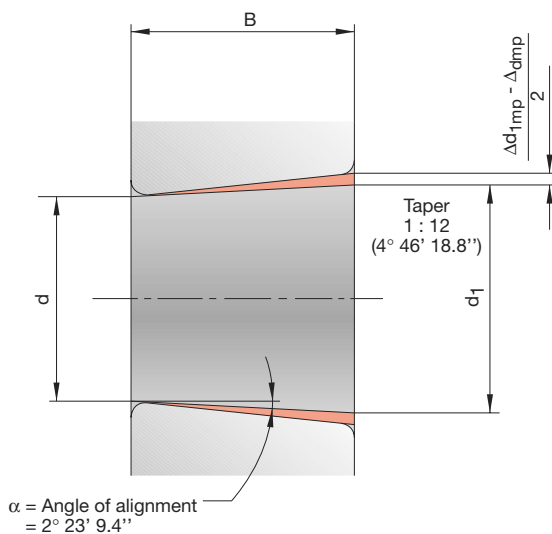

Bore diameter

d = Nominal bore diameter (tapered bore: smallest diameter)

d_1 = Nominal large-end diameter of tapered bores

$\Delta_{ds} = d_s - d$

Deviation of single bore diameter from nominal dimension in one radial plane

$\Delta_{dmp} = d_{mp} - d$

Deviation of mean bore diameter from nominal dimension in one radial plane

$\Delta_{d1mp} = d_{1mp} - d_1$

Deviation of mean large-end diameter of tapered bore from nominal dimension

$V_{dp} = d_{psmax} - d_{psmin}$

Variation of bore diameter in one radial plane

$V_{dmp} = d_{mpmax} - d_{mpmin}$

Variation of mean bore diameters of different radial planes

Outside diameter

D = Nominal outside diameter

$$\Delta_{D_s} = D_s - D$$

Deviation of single outside diameter from nominal dimension in one radial plane

$$\Delta_{D_{mp}} = D_{mp} - D$$

Deviation of mean outside diameter from nominal dimension in one radial plane

$$V_{D_p} = D_{psmax} - D_{psmin}$$

Variation of outside diameter in one radial plane

$$V_{D_{mp}} = D_{mpmax} - D_{mpmin}$$

Variation of mean outside diameters of different radial planes

Width and Height

$$\Delta_{B_s}, \Delta_{C_s} = B_s - B, C_s - C$$

Deviation of single inner ring width and outer ring width from nominal dimension

$$V_{B_s}, V_{C_s} = B_{smax} - B_{smin}, C_{smax} - C_{smin}$$

Variation of inner ring width and outer ring width

$$\Delta_{H_s} = H_s - H, \Delta_{H_{1s}} = H_{1s} - H_1, \Delta_{H_{2s}} = H_{2s} - H_2, \dots$$

Deviation of single overall thrust bearing height from nominal dimension

$$\Delta_{h_{as}} = h_{as} - h_a,$$

Deviation of single thrust bearing height from nominal dimension

Running accuracy

K_{ia} = Radial runout of assembled bearing inner ring

K_{ea} = Radial runout of assembled bearing outer ring

S_d = Side face runout of inner ring with reference to bore

S_D = Variation in inclination of outside cylindrical surface to outer ring side face

S_{ia} = Side face runout of assembled bearing inner ring to inner ring raceway (axial runout)

S_{ea} = Side face runout of assembled bearing outer ring to outer ring raceway (axial runout)

S_i = Wall thickness variation of thrust bearing housing washers

(axial runout of thrust bearings)

S_e = Wall thickness variation of thrust bearing shaft washers

(axial runout of thrust bearings)

TOLERANCES FOR SUPER PRECISION BEARINGS

Tolerances for Single Row Angular Contact Ball Bearings (Spindle Bearings)

Inner Ring		Dimensions in mm												
Nominal bore diameter	over	10	18	30	50	80	120	150	180	250	315	400	500	
	including	10	18	30	50	80	120	150	180	250	315	400	500	630
Tolerance Class P4S		Tolerances in μm												
Bore Deviation	$\Delta_{ds}, \Delta_{dmp}$	0	0	0	0	0	0	0	0	0	0	0	0	0
Variation	Series 8,9	-4	-4	-5	-6	-7	-8	-10	-10	-12	-15	-19	-23	-26
V_{dp}	Series 0,2	2.5	2.5	3	3	4	4.5	6	6	7	9	11	14	18
Width deviation	Δ_{Bs}	2	2	2.5	2.5	3	3.5	5	5	6	7	9	11	14
Width variation	V_{Bs}	0	0	0	0	0	0	0	0	0	0	0	0	0
Radial runout	K_{ia}	-100	-100	-120	-120	-150	-200	-250	-250	-300	-350	-400	-450	-500
Axial runout	S_d	1.5	1.5	1.5	1.5	1.5	1.5	2.5	4	5	6	7	8	10
Axial runout	S_{ia}	1.5	1.5	2.5	2.5	2.5	2.5	2.5	5	5	7	9	11	13

Outer Ring		Dimensions in mm												
Nominal outside diameter	over	10	18	30	50	80	120	150	180	250	315	400	500	630
	including	18	30	50	80	120	150	180	250	315	400	500	630	800
Tolerance Class P4S		Tolerances in μm												
Outside diameter Deviation	$\Delta_{Ds}, \Delta_{Dmp}$	0	0	0	0	0	0	0	0	0	0	0	0	0
Variation	Series 8,9	-4	-5	-6	-7	-8	-9	-10	-11	-13	-15	-18	-22	-26
V_{Dp}	Series 0,2	2.5	3	3	4	4.5	5	6	7	8	9	10	13	16
Width variation	V_{Cs}	2	2.5	2.5	3	3.5	4	5	5	6	7	8	10	12
Radial runout	K_{ea}	1.5	1.5	1.5	1.5	2.5	2.5	2.5	4	5	7	7	8	9
Variation of inclination	S_D	1.5	2.5	2.5	4	5	5	5	7	7	8	9	11	13
Axial runout	S_{ea}	1.5	1.5	1.5	1.5	2.5	2.5	2.5	4	5	7	8	9	10
Axial runout	S_{ea}	1.5	2.5	2.5	4	5	5	5	7	7	8	10	12	14

Width deviation Δ_{Cs} is identical with Δ_{Bs} of the corresponding inner ring.

Tolerances for Floating Displacement Bearings

Inner Ring		Dimensions in mm									
Nominal bore diameter	over	10	18	30	50	80	120	150	180	250	315
	including	18	30	50	80	120	150	180	250	315	400
Tolerance Class P4S		Tolerances in μm									
Bore Deviation	Δ_{ds}	0	0	0	0	0	0	0	0	0	0
Variation V_{dp}	Series 0	-4	-5	-6	-7	-8	-10	-10	-12	-15	-19
Width deviation		2	2.5	2.5	3	3.5	5	5	6	7	9
Width variation	Δ_{Bs}	0	0	0	0	0	0	0	0	0	0
Width variation	V_{Bs}	-80	-120	-120	-150	-200	-250	-250	-300	-350	-400
Radial runout	K_{ia}	1.5	1.5	1.5	1.5	2.5	2.5	4	5	6	7
Axial runout	S_d	1.5	1.5	1.5	1.5	2.5	2.5	4	5	6	7

Outer Ring		Dimensions in mm									
Nominal outside diameter	over	18	30	50	80	120	150	180	250	315	400
	including	30	50	80	120	150	180	250	315	400	500
Tolerance Class P4S		Tolerances in μm									
Outside diameter Deviation	Δ_{Ds}	0	0	0	0	0	0	0	0	0	0
Variation V_{Dp}	Series 0	-5	-6	-7	-8	-9	-10	-11	-13	-15	-18
Width Variation	V_{Cs}	2.5	2.5	3	3.5	4	5	5	6	7	8
Radial Runout	K_{ea}	1.5	1.5	1.5	2.5	2.5	2.5	4	5	7	7
Variation of Inclination	S_D	2.5	2.5	4	5	5	5	7	7	8	9
Axial Runout	S_{ea}	1.5	1.5	1.5	2.5	2.5	2.5	4	5	7	8
		2.5	2.5	4	5	5	5	7	7	8	10

Width deviation Δ_{Cs} is identical with Δ_{Bs} of the corresponding inner ring.

TOLERANCES FOR SUPER PRECISION BEARINGS

Tolerances for Single Row Cylindrical Roller Bearings

Inner Ring		Dimensions in mm									
Nominal bore diameter	over	18	30	50	80	120	180	250	315	400	
	including	30	50	80	120	180	250	315	400	500	
Tolerance Class SP		Tolerances in μm									
Bore, cylindrical		0	0	0	0	0	0	0	0	0	0
Deviation	$\Delta_{ds}, \Delta_{dmp}$	-6	-8	-9	-10	-13	-15	-18	-23	-27	
Variation	V_{dp}	3	4	5	5	7	8	9	12	14	
Bore, tapered		10	12	15	20	25	30	35	40	45	
Deviation	Δ_{dmp}	0	0	0	0	0	0	0	0	0	
Variation	V_{dp}	3	4	5	5	7	8	9	12	14	
Deviation	$\Delta_{d1mp} - \Delta_{dmp}$	4	6	6	8	8	10	12	12	14	
		0	0	0	0	0	0	0	0	0	
Width deviation	Δ_{Bs}	0	0	0	0	0	0	0	0	0	
		-120	-120	-150	-200	-250	-300	-350	-400	-450	
Width variation	V_{Bs}	1.5	2	3	3	4	5	5	6	7	
Radial runout	K_{ia}	3	4	4	5	6	8	9	12	14	
Axial runout	S_d	3	3	4	4	5	6	6	7	8	
Axial runout	S_{ia}	8	8	8	9	10	11	15	20	23	

Outer Ring		Dimensions in mm									
Nominal outside diameter	over	30	50	80	120	150	180	250	315	400	500
	including	50	80	120	150	180	250	315	400	500	630
Tolerance Class SP		Tolerances in μm									
Outside diameter		0	0	0	0	0	0	0	0	0	0
Deviation	$\Delta_{Ds}, \Delta_{Dmp}$	-7	-9	-10	-11	-13	-15	-18	-20	-23	-28
Variation	V_{Dp}	4	5	5	6	7	8	9	10	12	14
Width variation	V_{Cs}	5	5	6	7	7	8	10	13	15	18
Radial runout	K_{ea}	5	5	6	7	8	10	11	13	15	17
Variation of inclination	S_D	8	8	9	10	10	11	13	13	15	18
Axial runout	S_{ea}	8	10	11	13	14	15	18	20	23	25

Width deviation Δ_{Cs} is identical with Δ_{Bs} of the corresponding inner ring.

Tolerances for Double Row Cylindrical Roller Bearings

Inner Ring		Dimensions in mm									
Nominal bore diameter	over	18	30	50	80	120	180	250	315	400	500
	including	30	50	80	120	180	250	315	400	500	630
Tolerance Class SP		Tolerances in μm									
Bore, cylindrical		0	0	0	0	0	0	0	0	0	0
Deviation	$\Delta_{ds}, \Delta_{dmp}$	-6	-8	-9	-10	-13	-15	-18	-23	-27	-30
Variation	V_{dp}	3	4	5	5	7	8	9	12	14	16
Bore, tapered		10	12	15	20	25	30	35	40	45	50
Deviation	Δ_{dmp}	0	0	0	0	0	0	0	0	0	0
Variation	V_{dp}	3	4	5	5	7	8	9	12	14	16
Deviation	$\Delta_{d1mp} - \Delta_{dmp}$	4	6	6	8	8	10	12	12	14	16
		0	0	0	0	0	0	0	0	0	0
Width deviation	Δ_{Bs}	0	0	0	0	0	0	0	0	0	0
		-120	-120	-150	-200	-250	-300	-350	-400	-450	-500
Width variation	V_{Bs}	5	5	6	7	8	10	13	15	17	20
Radial runout	K_{ia}	3	4	4	5	6	8	8	10	10	12
Axial runout	S_d	8	8	8	9	10	11	13	15	17	20
Axial runout	S_{ia}	8	8	8	9	10	13	15	20	23	25

Outer Ring		Dimensions in mm										
Nominal outside diameter	over	30	50	80	120	150	180	250	315	400	500	630
	including	50	80	120	150	180	250	315	400	500	630	800
Tolerance Class SP		Tolerances in μm										
Outside diameter		0	0	0	0	0	0	0	0	0	0	0
Deviation	$\Delta_{Ds}, \Delta_{Dmp}$	-7	-9	-10	-11	-13	-15	-18	-20	-23	-28	-35
Variation	V_{Dp}	4	5	5	6	7	8	9	10	12	14	18
Width variation	V_{Cs}	5	6	8	8	8	10	11	13	15	18	20
Radial runout	K_{ea}	5	5	6	7	8	10	11	13	15	17	20
Variation of inclination	S_D	8	8	9	10	10	11	13	13	15	18	20
Axial runout	S_{ea}	8	10	11	13	14	15	18	20	23	25	30
Width deviation Δ_{Cs} is identical with Δ_{Bs} of the corresponding inner ring.												

TOLERANCES FOR SUPER PRECISION BEARINGS

Tolerances for Double Row Cylindrical Roller Bearings

Inner Ring		Dimensions in mm									
Nominal bore diameter	over	18	30	50	80	120	180	250	315	400	500
	including	30	50	80	120	180	250	315	400	500	630
Tolerance Class UP		Tolerances in μm									
Bore, cylindrical		0	0	0	0	0	0	0	0	0	0
Deviation	$\Delta_{ds}, \Delta_{dmp}$	-5	-6	-7	-8	-10	-12	-15	-19	-23	-26
Variation	V_{dp}	2.5	3	3.5	4	5	6	8	10	12	14
Bore, tapered		6	7	8	10	12	14	15	17	19	20
Deviation	Δ_{dmp}	0	0	0	0	0	0	0	0	0	0
Variation	V_{dp}	2.5	3	3.5	4	5	6	8	10	12	14
Deviation	$\Delta_{d1mp} - \Delta_{dmp}$	2	3	3	4	4	5	6	6	7	8
		0	0	0	0	0	0	0	0	0	0
Width deviation	Δ_{Bs}	0	0	0	0	0	0	0	0	0	0
		-25	-30	-40	-50	-60	-75	-100	-100	-100	-125
Width variation	V_{Bs}	1.5	2	3	3	4	5	5	6	7	8
Radial runout	K_{ia}	1.5	2	2	3	3	4	4	5	5	6
Axial runout	S_d	3	3	4	4	5	6	6	7	8	9
Axial runout	S_{ia}	3	3	3	4	6	7	8	9	10	12

Outer Ring		Dimensions in mm										
Nominal outside diameter	over	30	50	80	120	150	180	250	315	400	500	630
	including	50	80	120	150	180	250	315	400	500	630	800
Tolerance Class UP		Tolerances in μm										
Outside diameter		0	0	0	0	0	0	0	0	0	0	0
Deviation	$\Delta_{Ds}, \Delta_{Dmp}$	-5	-6	-7	-8	-9	-10	-12	-14	-17	-20	-25
Variation	V_{Dp}	3	3	4	4	5	5	6	7	9	10	13
Width variation	V_{Cs}	1	1.5	2	3	3	3.5	3.5	4	5	5.5	7.5
Radial runout	K_{ea}	3	3	3	4	4	5	6	7	8	9	11
Variation of inclination	S_D	2	2	3	3	3	4	4	5	5	6	7
Axial runout	S_{ea}	4	4	5	6	7	9	9	12	12	14	17

Width deviation Δ_{Cs} is identical with Δ_{Bs} of the corresponding inner ring.

Radial Clearance of FAG Cylindrical Roller Bearings

Bearings with Cylindrical Bore		Dimensions in mm																			
		over	24	30	40	50	65	80	100	120	140	160	180	200	225	250	280	315	355	400	450
Nominal bore	including	30	40	50	65	80	100	120	140	160	180	200	225	250	280	315	355	400	450	500	
Bearing clearance in μm																					
Bearing design																					
Clearance group C1*)	min	5	5	5	5	10	10	10	10	10	15	15	15	20	20	20	25	25	25		
	max	15	15	18	20	25	30	30	35	35	40	45	50	50	55	60	65	75	85	95	
Clearance group C2	min	0	5	5	10	10	15	15	20	25	35	45	45	55	55	65	100	110	110		
	max	25	30	35	40	45	50	55	60	70	75	90	105	110	125	130	145	190	210	220	

Bearings with Tapered Bore		Dimensions in mm																			
		over	24	30	40	50	65	80	100	120	140	160	180	200	225	250	280	315	355	400	450
Nominal bore	including	30	40	50	65	80	100	120	140	160	180	200	225	250	280	315	355	400	450	500	
Bearing clearance in μm																					
Bearing design																					
Clearance group C1*)	min	15	15	17	20	25	35	40	45	50	55	60	60	65	75	80	90	100	110	120	
	max	25	25	30	35	40	55	60	70	75	85	90	95	100	110	120	135	150	170	190	
Clearance group C2	min	20	20	25	30	35	40	50	55	60	75	85	95	105	115	130	145	165	185	205	
	max	45	45	55	60	70	75	90	100	110	125	140	155	170	185	205	225	255	285	315	

*) Bearings of tolerance classes SP and UP feature C1 radial clearance as standard; the bearing rings are not interchangeable (NA).

TOLERANCES FOR SUPER PRECISION BEARINGS

Tolerances for Angular Contact Thrust Ball Bearings (Series 2344 and 2347)

Shaft Washer		Dimensions in mm									
Nominal bore diameter	over	18	30	50	80	120	150	180	250	315	400
	including	30	50	80	120	150	180	250	315	400	500
Tolerance Class SP		Tolerances in μm									
Bore		0	0	0	0	0	0	0	0	0	0
Deviation	Δ_{dmp}	-8	-10	-12	-15	-18	-18	-22	-25	-30	-35
Variation	V_{dp}	6	8	9	11	14	14	17	19	22	26
Wall thickness variation	S_i	3	3	4	4	5	5	5	7	7	9
Height		50	75	100	125	150	150	175	200	250	300
variation	Δ_{Hs}	-150	-200	-250	-300	-350	-350	-400	-450	-600	-750
Tolerance Class UP		Tolerances in μm									
Bore		0	0	0	0	0	0	0	0	0	0
Deviation	Δ_{dmp}	-6	-8	-9	-10	-13	-13	-15	-18	-23	-27
Variation	V_{dp}	5	6	7	8	10	10	12	14	18	20
Wall thickness variation	S_i	1.5	1.5	2	2	3	3	3	4	4	5
Height		50	75	100	125	150	150	175	200	250	300
variation	Δ_{Hs}	-150	-200	-250	-300	-350	-350	-400	-450	-600	-750

Housing Washer		Dimensions in mm										
Nominal outside diameter	over	30	50	80	120	150	180	250	315	400	500	630
	including	50	80	120	150	180	250	315	400	500	630	800
Tolerance Class SP		Tolerances in μm										
Outside diameter		-20	-24	-28	-33	-33	-37	-41	-46	-50	-55	-60
Deviation	Δ_{Dmp}	-36	-43	-50	-58	-58	-66	-73	-82	-90	-99	-110
Variation	V_{dp}	5	6	8	9	9	10	12	13	15	16	18
Width deviation	Δ_{Cs}	-120	-120	-125	-125	-125	-125	-150	-150	-200	-200	-250
Wall thickness variation	S_e	3	4	4	5	5	5	7	7	9	11	13
Tolerance Class UP		Tolerances in μm										
Outside diameter		-20	-24	-28	-33	-33	-37	-41	-46	-50	-55	-55
Deviation	Δ_{Dmp}	-36	-43	-50	-58	-58	-66	-73	-82	-90	-99	-99
Variation	V_{dp}	5	6	8	9	9	10	12	13	15	16	18
Width deviation	Δ_{Cs}	-120	-120	-125	-125	-125	-125	-150	-150	-200	-200	-250
Wall thickness variation	S_e	1.5	2	2	3	3	3	4	4	5	6	7

Tolerances for Angular Contact Thrust Ball Bearings (Series 760 and BSB)

Shaft Washer		Dimensions in mm								
Nominal bore diameter	over	10	18	30	50	80	120	150	180	250
	including	18	30	50	80	120	150	180	250	315
Tolerance Class P4		Tolerances in μm								
Bore Deviation		0	0	0	0	0	0	0	0	0
Variation	Δ_{dmp}	-4	-5	-6	-7	-8	-10	-10	-12	-15
Width deviation	Δ_{Bs}	3	4	5	5	6	8	8	9	12
Width variation	V_{Bs}	0	0	0	0	0	0	0	0	0
Radial runout	K_{ia}	-80	-120	-120	-150	-200	-250	-250	-300	-350
Axial runout	S_{d}	2.5	2.5	3	4	4	5	5	6	8
Axial runout	S_{ia}	2.5	3	4	4	5	6	6	8	9
Axial runout	S_{ia}	3	4	4	5	5	6	6	7	8
Axial runout	S_{ia}	2	2	2	3	3	4	4	4	5

Housing Washer		Dimensions in mm								
Nominal outside diameter	over	18	30	50	80	120	150	180	250	315
	including	30	50	80	120	150	180	250	315	400
Tolerance Class P4		Tolerances in μm								
Outside diameter Deviation		0	0	0	0	0	0	0	0	0
Variation	Δ_{Dmp}	-5	-6	-7	-8	-9	-10	-11	-13	-15
Width variation	V_{Cs}	4	5	5	6	7	8	8	10	11
Radial runout	K_{ea}	2.5	2.5	3	4	5	5	7	7	8
Variation of inclination	S_{D}	4	5	5	6	7	8	10	11	13
Axial runout	S_{ea}	4	4	4	5	5	5	7	8	10
Axial runout	S_{ea}	2	2	3	3	4	4	4	5	6

Width deviation Δ_{Cs} is identical with Δ_{Bs} of the corresponding shaft washer.

TOLERANCES FOR SUPER PRECISION BEARINGS

Tolerances for Axial-Radial Cylindrical Roller Bearings (RTC)

Shaft Washer		Dimensions in mm													
Nominal bore diameter	over	50	80	120	150	180	250	315	400	500	630	800	1000	1250	
	including	80	120	150	180	250	315	400	500	630	800	1000	1250	1600	
		Tolerances in μm													
Bore Deviation	Δ_{ds}	0	0	0	0	0	0	0	0	0	0	0	0	0	
Variation	V_{dmp}	-9	-10	-13	-13	-15	-18	-23	-27	-33	-40	-50	-65	-80	
	V_{dp}	3.5	4	5	5	6	7	9	10	12	15	19	25	30	
Bearing height Deviation	Δ_{Hs}	7	8	10	10	12	14	18	20	24	30	38	50	60	
Cross section height Deviation	Δ_{has}	+25	+25	+30	+30	+30	+40	+50	+60	+75	+100	+120	+150	+200	
Radial runout	K_{ia}	-150	-150	-175	-175	-200	-250	-300	-350	-450	-600	-750	-900	-1200	
Wall thickness variation	S_i	+25	+25	+30	+30	+30	+40	+50	+60	+75	+100	+120	+150	+200	
Wall thickness variation	$S_{i(TS2E)}$	-25	-25	-30	-30	-30	-40	-50	-60	-75	-100	-120	-150	-200	
		3	3	3	4	4	5	5	6	7	8	8	9	11	
		3	3	3	4	4	5	5	6	7	8	8	9	11	
		1.5	1.5	1.5	2	2	3	3	3	5	5	6	7	8	

Housing Washer		Dimensions in mm													
Nominal outside diameter	over	120	150	180	250	315	400	500	630	800	1000	1250	1600		
	including	150	180	250	315	400	500	630	800	1000	1250	1600	2000		
		Tolerances in μm													
Outside diameter Deviation	Δ_{Ds}	0	0	0	0	0	0	0	0	0	0	0	0	0	
Variation	V_{Dmp}	-11	-13	-15	-18	-20	-23	-28	-35	-45	-55	-70	-85		
	V_{Dp}	4	5	6	7	8	9	10	13	17	20	27	32		
		8	10	12	14	16	18	20	26	34	40	54	64		
Radial runout K_{ea} and wall thickness variation S_e are identical with tolerance values K_{ia} and S_i for the shaft washer of the same bearing.															

Corner Dimensions

Limits for Corner Dimensions

Symbols:

- r_{smin}, r_{1smin} Symbol for the minimum corner dimensions in radial and axial direction
- r_{smaxr}, r_{1smaxr} Symbol for the maximum corner dimensions in radial direction
- r_{smaxa}, r_{1smaxa} Symbol for the maximum corner dimensions in axial direction

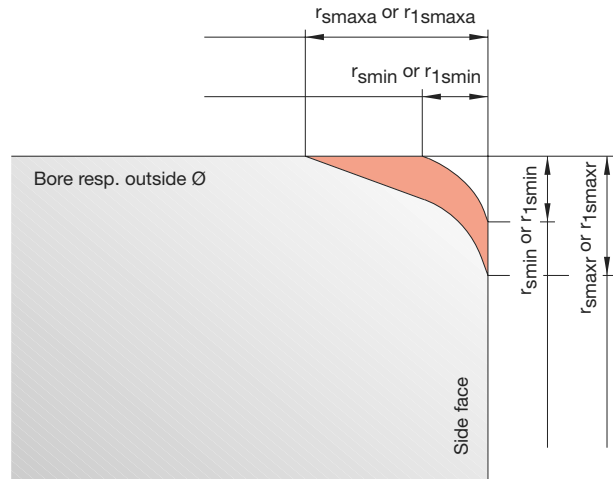

Corner Dimensions of Radial Bearings		Dimensions in mm																		
r_{smin}, r_{1smin}		0.1	0.15	0.2	0.3	0.3	0.3	0.6	0.6	0.6	1	1	1	1.1	1.1	1.1	1.5	1.5	1.5	
Nominal bore diameter "d"	over including	25	25	40	40	40	120	250	40	250	400	50	400	500	120	400	500	120	400	800
r_{smaxr}, r_{1smaxr}	rad.	0.2	0.3	0.5	0.6	0.8	1	1	1.3	1.5	1.5	1.9	2.5	2	2.5	2.7	2.3	3	3.5	
r_{smaxa}, r_{1smaxa}	ax.	0.4	0.6	0.8	1	1	1.7	2	2	2.6	3	3	3.5	3.5	4	4.5	4	5	5	
r_{smin}, r_{1smin}		2	2	2	2.1	2.1	2.5	2.5	2.5	2.5	2.5	3	3	4	5	6	7.5			
Nominal bore diameter "d"	over including	80	220	800	280	1200	100	280	800	1200	280	1200	1200	2000	2000	3000	3000	3000		
r_{smaxr}, r_{1smaxr}	rad.	3	3.5	3.8	4	4.5	3.8	4.5	5	5	5	5.5	6.5	8	10	12.5				
r_{smaxa}, r_{1smaxa}	ax.	4.5	5	6	6.5	7	6	6	7	7.5	8	8	9	10	13	17				

Corner Dimensions of Thrust Bearings		Dimensions in mm																	
r_{smin}, r_{1smin}		0.1	0.15	0.2	0.3	0.3	0.6	1	1	1.1	1.5	2	2.1	3	4	5	6	7.5	
Nominal bore diameter "d"	over including	25	25	40	120	250	400	500	800	800	1200	1200	1200	2000	2000	3000	3000	3000	
r_{smaxr}, r_{1smaxr}	rad.	0.2	0.3	0.5	0.8	1	1.5	2.2	2.6	2.7	3.5	4	4.5	5.5	6.5	8	10	12.5	
r_{smaxa}, r_{1smaxa}	ax.	0.2	0.3	0.5	0.8	1	1.5	2.2	2.6	2.7	3.5	4	4.5	5.5	6.5	8	10	12.5	

MACHINING TOLERANCES FOR MATING PARTS

Definitions

Machining Tolerances for Mating Parts

The performance capability of super precision bearings in terms of speed-ability and running accuracy is continuously increasing. However, only if the precision of the mating parts is in line with that of the bearings, will it be possible to exploit this enhanced performance capability.

The tolerances of dimension, form and position listed in the following tables have proven suitable in many applications of super precision bearings. The values are a means for better and quicker fit selection and ensure reliable function and exchangeability. The mean roughness values R_a of the bearing seats must not be exceeded so that the recommended fits remain within a limit of alteration. (smoothing)

The universally applicable rules of rolling bearing technology which consider the

- direction and effect of load
 - rotation of inner or outer ring
 - alteration of fit due to temperatures and centrifugal forces
- must also be observed.

Shaft

Tolerance Symbols

- d = Nominal diameter of shaft or small end taper
- d_1 = Nominal diameter of large end taper
 $d_1 = d + 1/12 \cdot L$
- L = Length of taper $L = 0.95 \cdot B$
 (B = bearing width)
- t_1 \mathcal{H} = Cylindrical form tolerance (DIN ISO 1101)
- t_2 \bigcirc = Roundness tolerance (DIN ISO 1101)
- t_3 \square = Flatness tolerance (DIN ISO 1101)
- t_4 \nearrow = Axial runout tolerance (DIN ISO 1101)
- t_5 \odot = Coaxiality tolerance (DIN ISO 1101)
- AT_D = Taper angle tolerance (DIN 7178)
- R_a = Mean surface roughness (DIN 4768)

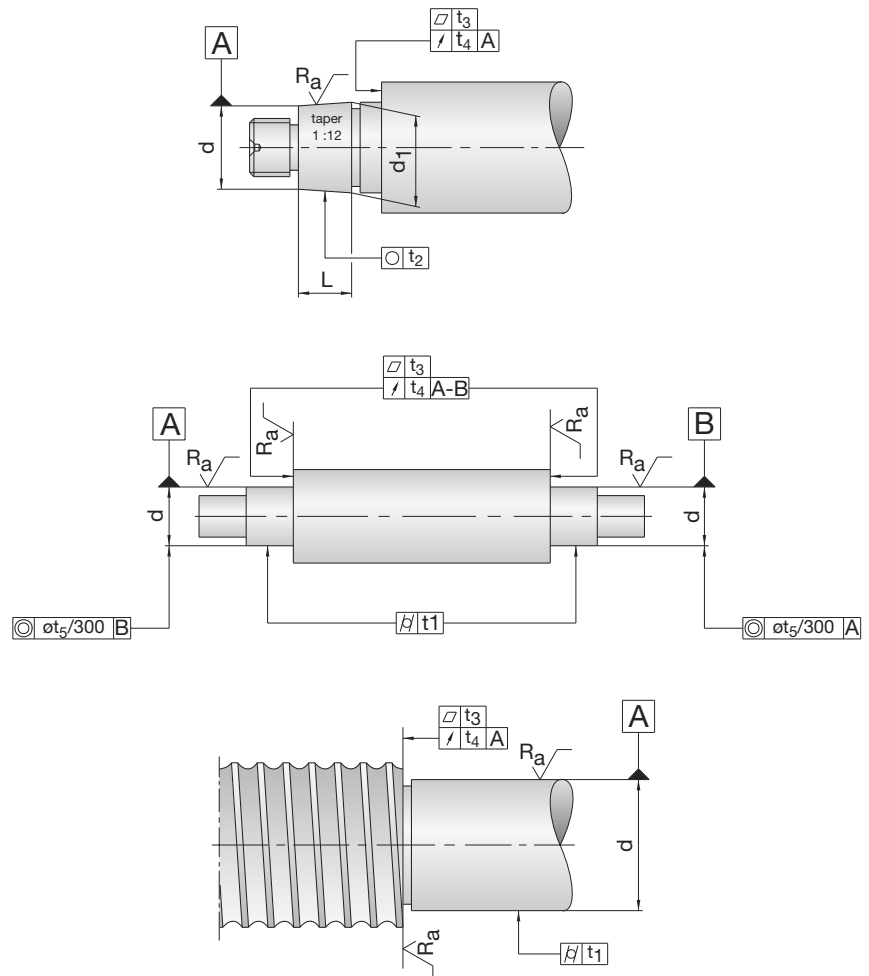

Housing

Tolerance Symbols

- D = Nominal housing bore
 t_1 β = Cylindrical form tolerance (DIN ISO 1101)
 t_3 \square = Flatness tolerance (DIN ISO 1101)
 t_4 \nearrow = Axial runout tolerance (DIN ISO 1101)
 t_5 \odot = Coaxiality tolerance (DIN ISO 1101)
 R_a = Mean surface roughness (DIN 4768)

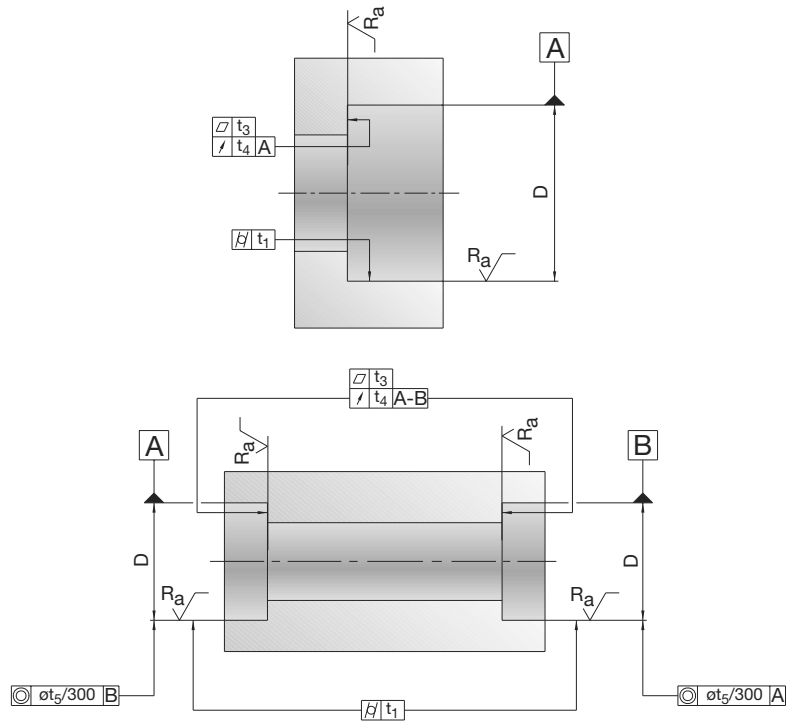

Spacer sleeves

Tolerance Symbols

- d_2 = Nominal spacer sleeve bore
 D_2 = Cylindrical form tolerance
 t_1 β = Zylinderform (DIN ISO 1101)
 t_4 \nearrow = Axial runout tolerance (DIN ISO 1101)
 t_6 \nearrow = Parallelism tolerance (DIN ISO 1101)
 t_7 \parallel = Radial runout tolerance (DIN ISO 1101)
 R_a \nearrow = Mean surface roughness (DIN 4768)

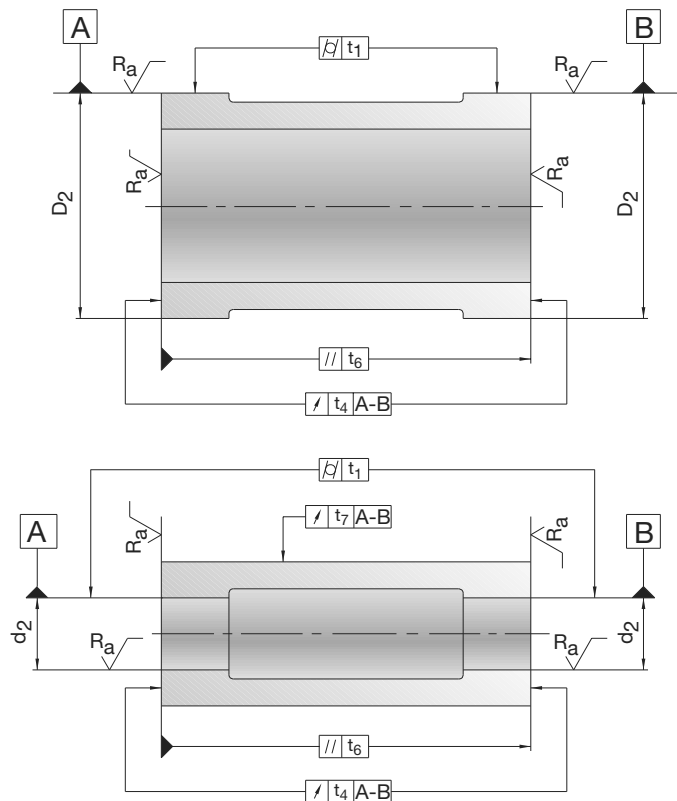

MACHINING TOLERANCES FOR MATING PARTS

Definitions

Design of Surrounding Structure for Axial-Radial Cylindrical Roller Bearings

Tolerance Symbols

d_3 = Nominal shaft diameter

D_3 = Nominal housing bore

t_2 \bigcirc = Roundness tolerance (DIN ISO 1101)

t_6 $//$ = Parallelism tolerance (DIN ISO 1101)

t_8 \perp = Perpendicularity tolerance (DIN ISO 1101)

R_a = Mean surface roughness (DIN 4768)

$$r_{amax} = \frac{r_{smin}}{2}$$

$$r_{bmax} = \frac{r_{1smin}}{2}$$

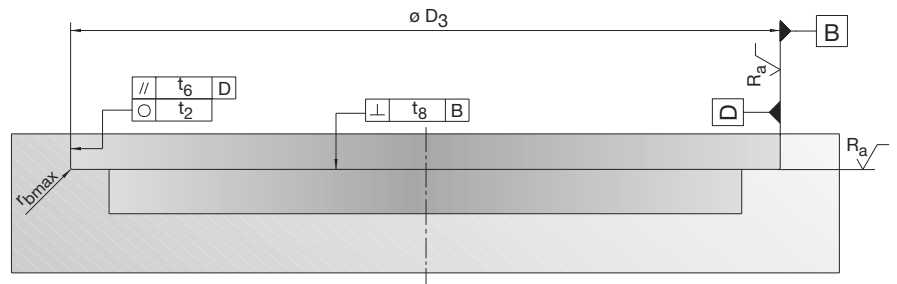
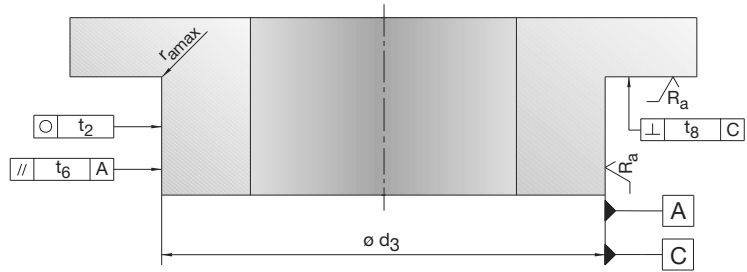

Shafts and Housings for Spindle Bearings

Tolerance Recommendations for Machining the Shafts for Spindle Bearings													
Dimensions in mm													
Nominal shaft diameter d	over	0	10	18	30	50	80	120	180	250	315	400	500
	including	10	18	30	50	80	120	180	250	315	400	500	630
Tolerances in μm													
Deviation of d		2	2.5	3	3.5	4	5	6	7	8	9	10	11
		-2	-2.5	-3	-3.5	-4	-5	-6	-7	-8	-9	-10	-11
Cylindricity	t_1	0.6	0.8	1	1	1.2	1.5	2	3	4	5	6	7
Flatness	t_3	0.6	0.8	1	1	1.2	1.5	2	3	4	5	6	7
Axial runout	t_4	1	1.2	1.5	1.5	2	2.5	3.5	4.5	6	7	8	9
Coaxiality	t_5	2.5	3	4	4	5	6	8	10	12	13	15	16
Mean surface roughness	R_a	0.2	0.2	0.2	0.2	0.4	0.4	0.4	0.4	0.8	0.8	0.8	0.8

Tolerance Recommendations for Machining the Housings for Spindle Bearings													
Dimensions in mm													
Nominal housing diameter D	over	10	18	30	50	80	120	180	250	315	400	500	630
	including	18	30	50	80	120	180	250	315	400	500	630	800
Tolerances in μm													
Deviation of D	Locating bearing	+3	+4	+4	+5	+6	+8	+10	+12	+13	+15	+16	+17
		-2	-2	-3	-3	-4	-4	-4	-4	-5	-5	-6	-7
Cylindricity	Floating bearing	+7	+8	+10	+11	+14	+17	+21	+24	+27	+30	+33	+36
		+2	+2	+3	+3	+4	+5	+7	+8	+9	+10	+11	+12
Cylindricity	t_1	1.2	1.5	1.5	2	2.5	3.5	4.5	6	7	8	9	10
Flatness	t_3	1.2	1.5	1.5	2	2.5	3.5	4.5	6	7	8	9	10
Axial runout	t_4	2	2.5	2.5	3	4	5	7	8	9	10	11	12
Coaxiality	t_5	3	4	4	5	6	8	10	12	13	15	16	18
Mean surface roughness	R_a	0.4	0.4	0.4	0.4	0.8	0.8	0.8	1.6	1.6	1.6	1.6	1.6

MACHINING TOLERANCES FOR MATING PARTS

Inner and Outer Spacer Sleeves

Tolerance Recommendations for Machining Inner Spacer Sleeves													
Dimensions in mm													
Nominal sleeve bore diameter d_2	over	0	10	18	30	50	80	120	180	250	315	400	500
	including	10	18	30	50	80	120	180	250	315	400	500	630
Tolerances in μm													
Deviation of d_2		9	11	13	16	19	22	25	29	32	36	40	44
		0	0	0	0	0	0	0	0	0	0	0	0
Cylindricity	t_1	2.5	3	4	4	5	6	8	10	12	13	15	16
Axial runout	t_4	1	1.2	1.5	1.5	2	2.5	3.5	4.5	6	7	8	9
Parallelism	t_6	1	1.2	1.5	1.5	2	2.5	3.5	4.5	6	7	8	9
Radial runout	t_7	2.5	3	4	4	5	6	8	10	12	13	15	16
Mean surface roughness (incl. side faces)	R_a	0.4	0.4	0.4	0.4	0.4	0.8	0.8	0.8	1.6	1.6	1.6	1.6

Tolerance Recommendations for Machining Outer Spacer Sleeves													
Dimensions in mm													
Nominal outside sleeve diameter D_2	over	10	18	30	50	80	120	180	250	315	400	500	630
	including	18	30	50	80	120	180	250	315	400	500	630	800
Tolerances in μm													
Deviation of D_2		-6	-7	-9	-10	-12	-14	-15	-17	-18	-20	-22	-24
		-17	-20	-25	-29	-34	-39	-44	-49	-54	-60	-66	-74
Cylindricity	t_1	3	4	4	5	6	8	10	12	13	15	16	18
Axial runout	t_4	2	2.5	2.5	3	4	5	7	8	9	10	11	12
Parallelism	t_6	1.2	1.5	1.5	2	2.5	3.5	4.5	6	7	8	9	10
Mean surface roughness (incl. side faces)	R_a	0.4	0.4	0.4	0.4	0.8	0.8	0.8	1.6	1.6	1.6	1.6	1.6

If not explicitly prescribed in the drawing, both spacer sleeves should have the same length. For this purpose, the side faces of the two sleeves should be ground in one chucking.

Cylindrical Shafts and Housings for Cylindrical Roller Bearings

Tolerance Recommendations for Machining the Cylindrical Shafts for Cylindrical Roller Bearings											
Dimensions in mm											
Nominal shaft diameter d	over	18	30	50	80	120	180	250	315	400	500
	including	30	50	80	120	180	250	315	400	500	630
Tolerance Class SP		Tolerances in μm									
Deviation of d		3	3.5	4	5	6	7	8	9	10	11
		-3	-3.5	-4	-5	-6	-7	-8	-9	-10	-11
Cylindricity	t_1	1	1	1.2	1.5	2	3	4	5	6	7
Flatness	t_3	1	1	1.2	1.5	2	3	4	5	6	7
Axial runout	t_4	1.5	1.5	2	2.5	3.5	4.5	6	7	8	9
Coaxiality	t_5	4	4	5	6	8	10	12	13	15	16
Mean surface roughness	R_a	0.2	0.2	0.4	0.4	0.4	0.4	0.8	0.8	0.8	0.8
Tolerance Class UP		Tolerances in μm									
Deviation of d		2	2	2.5	3	4	5	6	6.5	7.5	8
		-2	-2	-2.5	-3	-4	-5	-6	-6.5	-7.5	-8
Cylindricity	t_1	0.6	0.6	0.8	1	1.2	2	2.5	3	4	5
Flatness	t_3	0.6	0.6	0.8	1	1.2	2	2.5	3	4	5
Axial runout	t_4	1	1	1.2	1.5	2	3	4	5	6	7
Coaxiality	t_5	2.5	2.5	3	4	5	7	8	9	10	11
Mean surface roughness	R_a	0.2	0.2	0.2	0.2	0.2	0.2	0.4	0.4	0.4	0.4

Tolerance Recommendations for Machining the Housings for Cylindrical Roller Bearings											
Dimensions in mm											
Nominal housing diameter D	over	30	50	80	120	180	250	315	400	500	630
	including	50	80	120	180	250	315	400	500	630	800
Tolerance Class SP		Tolerances in μm									
Deviation of D		+2	+3	+2	+3	+2	+3	+3	+2	0	0
		-9	-10	-13	-15	-18	-20	-22	-25	-30	-35
Cylindricity	t_1	1.5	2	2.5	3.5	4.5	6	7	8	9	10
Flatness	t_3	1.5	2	2.5	3.5	4.5	6	7	8	9	10
Axial runout	t_4	2.5	3	4	5	7	8	9	10	11	12
Coaxiality	t_5	4	5	6	8	10	12	13	15	16	18
Mean surface roughness	R_a	0.4	0.4	0.8	0.8	0.8	1.6	1.6	1.6	1.6	1.6
Tolerance Class UP		Tolerances in μm									
Deviation of D		+1	+1	+1	+1	0	0	+1	0	0	0
		-6	-7	-9	-11	-14	-16	-17	-20	-24	-28
Cylindricity	t_1	1	1.2	1.5	2	3	4	5	6	7	8
Flatness	t_3	1	1.2	1.5	2	3	4	5	6	7	8
Axial runout	t_4	1.5	2	2.5	3.5	4.5	6	7	8	9	10
Coaxiality	t_5	2.5	3	4	5	7	8	9	10	11	12
Mean surface roughness	R_a	0.2	0.4	0.4	0.4	0.4	0.8	0.8	0.8	1.6	1.6

MACHINING TOLERANCES FOR MATING PARTS

Tapered Shafts for Cylindrical Roller Bearings and Taper Angles

Tolerance Recommendations for Machining the Tapered Shafts for Cylindrical Roller Bearings																					
Dimensions in mm																					
Nominal shaft diameter d	over including	18	30	40	50	65	80	100	120	140	160	180	200	225	250	280	315	355	400	450	500
Tolerance Class SP		Tolerances in μm																			
Deviation of small-end taper diameter		+73	+91	+108	+135	+159	+193	+225	+266	+298	+328	+370	+405	+445	+498	+548	+615	+685	+767	+847	+928
Roundness	t_2	1	1	1	1.2	1.2	1.5	1.5	2	2	2	3	3	3	4	4	5	5	6	6	7
Flatness	t_3	1	1	1	1.2	1.2	1.5	1.5	2	2	2	3	3	3	4	4	5	5	6	6	7
Axial runout	t_4	1.5	1.5	1.5	2	2	2.5	2.5	3.5	3.5	3.5	4.5	4.5	4.5	6	6	7	7	8	8	9
Mean surface roughn. R_a		0.2	0.2	0.2	0.2	0.2	0.2	0.2	0.2	0.2	0.2	0.2	0.2	0.2	0.4	0.4	0.4	0.4	0.4	0.4	0.4
Tolerance Class UP		Tolerances in μm																			
Deviation of small-end taper diameter		+73	+91	+108	+135	+159	+193	+225	+266	+298	+328	+370	+405	+445	+498	+548	+615	+685	+767	+847	+928
Roundness	t_2	0.6	0.6	0.6	0.8	0.8	1	1	1.2	1.2	1.2	2	2	2	2.5	2.5	3	3	4	4	5
Flatness	t_3	0.6	0.6	0.6	0.8	0.8	1	1	1.2	1.2	1.2	2	2	2	2.5	2.5	3	3	4	4	5
Axial runout	t_4	1	1	1	1.2	1.2	1.5	1.5	2	2	2	3	3	3	4	4	5	5	6	6	7
Mean surface roughn. R_a		0.2	0.2	0.2	0.2	0.2	0.2	0.2	0.2	0.2	0.2	0.2	0.2	0.2	0.4	0.4	0.4	0.4	0.4	0.4	0.4

Deviation of Taper Angle		Dimensions in mm											
Nominal taper length L		>16...25	>25...40	>40...63	>63...100	>100...160	>160...250						
Tolerance Class SP		Tolerances in μm											
Taper angle tolerance AT_D		+2	+3.2	+2.5	+4	+3.2	+5	+4	+6.3	+5	+8	+6.3	+10
		0	0	0	0	0	0	0	0	0	0	0	0
Tolerance Class UP		Tolerances in μm											
Taper angle tolerance AT_D		+1.3	+2	+1.6	+2.5	+2	+3.2	+2.5	+4	+3.2	+5	+4	+6,3
		0	0	0	0	0	0	0	0	0	0	0	0
The taper angle tolerance AT_D is measured vertically to the axis and is defined as a diameter difference.													
When using FAG taper measuring instruments MGK 132, the listed AT_D values must be cut by half (inclination angle tolerance).													
For taper lengths the nominal dimensions of which lie in between the values listed in the tables, the taper angle tolerance AT_D is determined through interpolation.													
Example: Taper length 50 mm, bearing of tolerance class SP.													
$AT_D = AT_{DU} + \frac{\Delta AT_D}{\Delta L} \cdot (L - L_u) = 3.2 + \frac{5 - 3.2}{63 - 40} \cdot (50 - 40) = 3.98 \mu\text{m} \quad \text{The taper angle tolerance } AT_D = + 4 \mu\text{m}$													

Shafts and Housings for Angular Contact Thrust Ball Bearings (2344, 2347)

Tolerance Recommendations for Machining the Shafts for Double Direction Angular Contact Thrust Ball Bearings for Main Spindles (2344, 2347)										
		Dimensions in mm								
Nominal shaft diameter	over	18	30	50	80	120	180	250	315	400
	including	30	50	80	120	180	250	315	400	500
Tolerance Class SP		Tolerances in μm								
Deviation of d		0	0	0	0	0	0	0	0	0
		-6	-7	-8	-10	-12	-14	-16	-18	-20
Cylindricity	t_1	1	1	1.2	1.5	2	3	4	5	6
Flatness	t_3	1	1	1.2	1.5	2	3	4	5	6
Axial runout	t_4	1.5	1.5	2	2.5	3.5	4.5	6	7	8
Mean surface roughness	R_a	0.2	0.2	0.4	0.4	0.4	0.4	0.8	0.8	0.8
Tolerance Class UP		Tolerances in μm								
Deviation of d		0	0	0	0	0	0	0	0	0
		-4	-4	-5	-6	-8	-10	-12	-13	-15
Cylindricity	t_1	0.6	0.6	0.8	1	1.2	2	2.5	3	4
Flatness	t_3	0.6	0.6	0.8	1	1.2	2	2.5	3	4
Axial runout	t_4	1	1	1.2	1.5	2	3	4	5	6
Mean surface roughness	R_a	0.2	0.2	0.2	0.2	0.2	0.2	0.4	0.4	0.4

Tolerance Recommendations for Machining the Housings for Double Direction Angular Contact Thrust Ball Bearings for Main Spindles (2344, 2347)											
		Dimensions in mm									
Nominal housing diameter D	over	30	50	80	120	180	250	315	400	500	630
	including	50	80	120	180	250	315	400	500	630	800
Tolerance Class SP		Tolerances in μm									
Deviation of D		+2	+3	+2	+3	+2	+3	+3	+2	0	0
		-9	-10	-13	-15	-18	-20	-22	-25	-30	-35
Cylindricity	t_1	1.5	2	2.5	3.5	4.5	6	7	8	9	10
Flatness	t_3	1	1.2	1.5	2	3	4	5	6	7	8
Axial runout	t_4	1.5	2	2.5	3.5	4.5	6	7	8	9	10
Mean surface roughness	R_a	0.8	0.8	0.8	0.8	0.8	1.6	1.6	1.6	1.6	1.6
Tolerance Class UP		Tolerances in μm									
Deviation of D		+1	+1	+1	+1	0	0	+1	0	0	0
		-6	-7	-9	-11	-14	-16	-17	-20	-24	-28
Cylindricity	t_1	1	1.2	1.5	2	3	4	5	6	7	8
Flatness	t_3	0.6	0.8	1	1.2	2	2.5	3	4	5	6
Axial runout	t_4	1	1.2	1.5	2	3	4	5	6	7	8
Mean surface roughness	R_a	0.2	0.4	0.4	0.4	0.4	0.8	0.8	0.8	1.6	1.6

MACHINING TOLERANCES FOR MATING PARTS

Shafts and Housings for Single Angular Contact Thrust Ball Bearings for Ball Screws (7602, 7603 and BSB)

Tolerance Recommendations for Machining the Shafts for Angular Contact Thrust Ball Bearings for Ball Screws									
Dimensions in mm									
Nominal shaft diameter d	over	10	18	30	50	80	120	180	250
	including	18	30	50	80	120	180	250	315
Tolerances in μm									
Deviation of d		0	0	0	0	0	0	0	0
		-8	-9	-11	-13	-15	-18	-20	-23
Cylindricity	t_1	2	2.5	2.5	3	4	5	7	8
Flatness	t_3	1.2	1.5	1.5	2	2.5	3.5	4.5	6
Axial runout	t_4	2	2.5	2.5	3	4	5	7	8
Mean surface roughness	R_a	0.4	0.4	0.4	0.4	0.4	0.4	0.8	0.8

Tolerance Recommendations for Machining the Housings for Angular Contact Thrust Ball Bearings for Ball Screws									
Dimensions in mm									
Nominal housing diameter D	over	18	30	50	80	120	180	250	315
	including	30	50	80	120	180	250	315	400
Tolerances in μm									
Deviation of D		+8	+10	+13	+16	+18	+22	+25	+29
		-5	-6	-6	-6	-7	-7	-7	-7
Cylindricity	t_1	2.5	2.5	3	4	5	7	8	9
Flatness	t_3	2.5	2.5	3	4	5	7	8	9
Axial runout	t_4	4	4	5	6	8	10	12	13
Mean surface roughness	R_a	0.8	0.8	0.8	0.8	0.8	0.8	1.6	1.6

Mating Structure for Axial-Radial Cylindrical Roller Bearings (RTC)

Tolerance Recommendations for Machining the Shafts for Axial-Radial Cylindrical Roller Bearings														
Dimensions in mm														
Nominal shaft diameter d_3	over including	50	80	120	150	180	250	315	400	500	630	800	1000	1250
		80	120	150	180	250	315	400	500	630	800	1000	1250	1600
Tolerances in μm														
Deviation of d_3		0	0	0	0	0	0	0	0	0	0	0	0	0
		-13	-15	-18	-18	-20	-23	-25	-27	-28	-32	-36	-42	-50
Roundness	t_2	5	6	8	8	10	12	13	15	16	18	20	24	28
Parallelism	t_6	3	4	5	5	7	8	9	10	11	12	14	16	20
Perpendicularity	t_8	3	4	5	5	7	8	9	10	11	12	14	16	20
Mean surface roughness	R_a	0.4	0.4	0.8	0.8	0.8	0.8	0.8	0.8	1.6	1.6	1.6	1.6	1.6

Tolerance Recommendations for Machining the Housings for Axial-Radial Cylindrical Roller Bearings														
Dimensions in mm														
Nominal housing diameter D_3	over including	120	150	180	250	315	400	500	630	800	1000	1250	1600	2000
		150	180	250	315	400	500	630	800	1000	1250	1600	2000	
Tolerances in μm														
Deviation of D_3		+18	+18	+22	+25	+29	+33	+34	+38	+44	+52	+64	+76	
		-7	-7	-7	-7	-7	-7	-10	-12	-12	-14	-14	-16	
Roundness	t_2	8	8	10	12	13	15	16	18	20	24	28	32	
Parallelism	t_6	5	5	7	8	9	10	11	12	14	16	20	22	
Perpendicularity	t_8	5	5	7	8	9	10	11	12	14	16	20	22	
Mean surface roughness	R_a	0.8	0.8	0.8	0.8	0.8	0.8	1.6	1.6	1.6	1.6	1.6	1.6	

SPEED-DEPENDENT FITS

Speed-Dependent Fits

FAG super precision bearings can be used at maximum speeds. Speed indices of $n \cdot d_m$ up to $2.0 \cdot 10^6$ mm/min are attainable with grease lubrication, while oil-lubricated bearings can attain speeds as high as $3.0 \cdot 10^6$ mm/min and beyond. Such high speeds cause high centrifugal forces which act on the inner rings and cause them to expand.

This ring expansion leads to a lifting off of the inner ring from the shaft and thus to clearance between inner ring and shaft. The result is fretting corrosion and, possibly, turning of the ring on the

shaft, poor shaft guidance with increased tendency to vibration and reduced bearing performance due to possible misalignment. These effects can be avoided through a correspondingly tight fit on the shaft.

The required interference can be obtained from Diagram 29 or calculated with the help of the *SpiCaS* 2000 program (see page 174). The values determined in this way yield a fit with a remaining interference of $1 \mu\text{m}$ at maximum speed.

High interference leads to an increase in preload, in particular in the case of rigid adjusted bearings. This in turn leads to increased heat

generation in the bearing arrangement as well as losses in terms of speed-ability. This preload increase must be compensated by appropriate measures. With values $n^2 \cdot f_w > 1.2$ (red zone in Diagram 29), it is advisable to consult the application engineering department of FAG AC/SP.

The value f_w can be obtained from Diagram 30 (for bearings of type B, HCB and XCB) and Diagram 31 (for bearings of type HS, HC and XC). If value $n_2 \cdot f_w < 1.2$, the resulting shaft dimension is as follows:

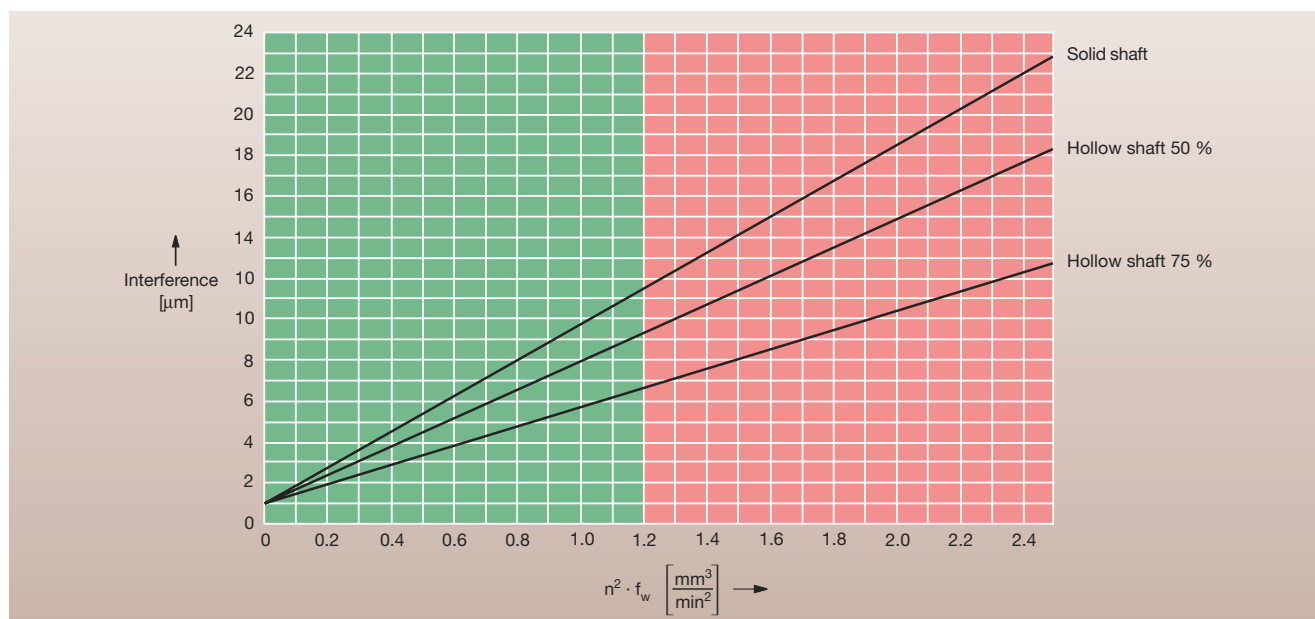

29: Speed-dependent determination of interference shaft/inner ring

Example:

HCS71914E.T.P4S.UL

Speed $n = 16000 \text{ min}^{-1}$

Actual dimension of inner ring:
 $70 \text{ mm} - 3 \text{ }\mu\text{m} = 69.997 \text{ mm}$.

The deviation from the nominal dimension is indicated on the bearing ring (see page 176).

Hollow shaft of 35 mm bore (50 % of diameter)

$f_w = 4.30 \cdot 10^{-9}$ (according to Diagram 31 for bearing type s HS, HC and XC)

$$n^2 \cdot f_w = 1.1$$

The value 1.1 and curve "Hollow shaft 50%" (Diagram 29) result

in a required interference of $9 \text{ }\mu\text{m}$.

So the actual dimension of the shaft must be 70.006 mm to ensure that the inner ring will still be tightly located on the shaft at a speed of $n = 16000 \text{ min}^{-1}$.

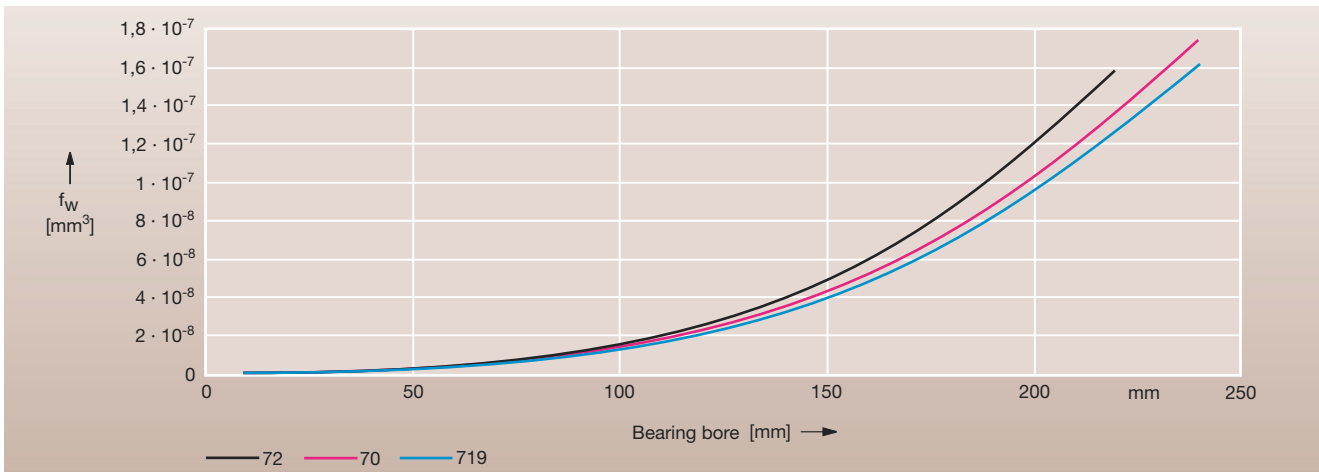

30: Factor f_w for the speed-dependent determination of the inner ring/shaft fit for bearing series B, HCB, XCB...C, E.T.P4S

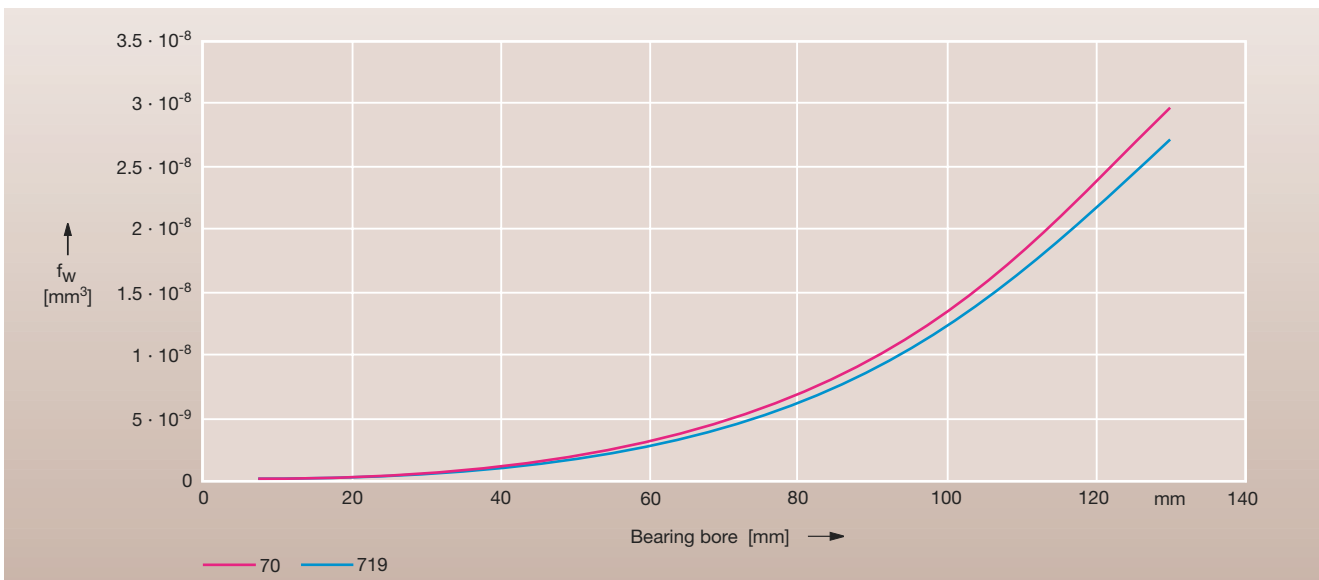

31: Factor f_w for the speed-dependent determination of the inner ring/shaft fit for bearing series HS, HC, XC...C, E.T.P4S

SPEEDS

Speeds







The speeds attainable by a specific bearing arrangement depend on the overall energy balance of the system. The number of bearings, their position, internal stress (clearance or preload), external stress and lubrication on the one hand as well as the heat dissipation conditions on the other hand are the decisive factors here. The attainable speed figures in the bearing tables are guide values that may be higher or lower, depending on the mentioned conditions.

Spindle Bearings

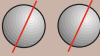

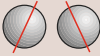
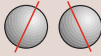
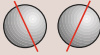
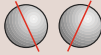
The attainable speeds stated in the bearing tables are an indication of the speed-ability of elastically preloaded single bearings. These speeds are not attained by rigidly preloaded bearings, bearing pairs or groups. The reduction factors to be assumed here are shown in Table 32.

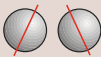
Angular Contact Thrust Ball Bearings of Series 7602, 7603 and BSB

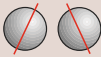
The permissible speeds for grease-lubricated bearings are shown in the bearing table. The indicated values apply to a bearing pair in back-to-back or face-to-face arrangement. For other bearing arrangements the reduction factors according to Table 33 have to be used.

Bearing Arrangement	Factor f_p , Bearing Preload		
	L	M	H
Large bearing distance			
			0.85
			0.8
			0.75
Locating bearing		Floating bearing	
			0.75
			0.65
			0.65
			0.72
			0.6
			0.5
			0.5
			0.37

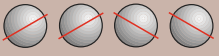
32: Speed reduction ($n^* \cdot f_p$) for spindle bearing sets

Bearing Arrangement	Attainable Speeds
	$1.0 \cdot n^*$
	$0.70 \cdot n^*$
	$0.85 \cdot n^*$
	$0.75 \cdot n^*$
	$0.65 \cdot n^*$

* Speed see bearing tables

33: Speed reduction for angular contact thrust ball bearing sets

Cylindrical Roller Bearings

For cylindrical roller bearings the attainable speed is determined through the adjusted radial clearance. See Table 34 for corresponding indications.

Mounting Clearance/Preload	Attainable Speeds
Single row cylindrical roller bearings	
- 5 ... 0 [μm]	$< 0.75 \cdot n^*$ grease
0 [μm] (zero clearance)	$0.75 \dots 1.0 \cdot n^*$ grease
0 ... 3 [μm]	$1 \dots 1.1 \cdot n^*$ grease
0 ... 3 [μm]	$1.0 \cdot n^*$ oil
Double row cylindrical roller bearings	
- 5 ... 0 [μm]	$< 0.50 \cdot n^*$ grease
$2 \cdot 10^{-5} \cdot d_m$ [mm]	$0.50 \dots 0.75 \cdot n^*$ grease
$4 \cdot 10^{-5} \cdot d_m$ [mm]	$0.75 \dots 1.0 \cdot n^*$ grease
$1 \cdot 10^{-4} \cdot d_m$ [mm]	$1.0 \cdot n^*$ oil
* Speeds see bearing tables	
$d_m = (d + D)/2$	
These values apply to ΔT up to 5 K between inner and outer ring.	

34: Speed n for cylindrical roller bearings

DEFLECTION AND RIGIDITY

Deflection and Rigidity

High running accuracies even under alternating loads can be achieved with zero-clearance bearing arrangements. They are arranged and preloaded depending on the load and required rigidity. The rigidity can be increased by mounting bearing sets.





Spindle Bearings

The axial rigidity values stated in the bearing tables apply to bearing pairs in back-to-back or face-to-face arrangement. The radial rigidity can be estimated from the axial rigidity by means of a factor.

$$S_r \approx 6 \cdot S_a \text{ for } \alpha = 15^\circ$$

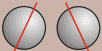

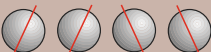
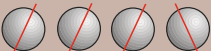
$$S_r \approx 2 \cdot S_a \text{ for } \alpha = 25^\circ$$

Sets of more than two bearings feature increased rigidity values. Table 35 shows the determination of the axial rigidity at a centrically acting axial load. The radial rigidity for such sets with a radial load acting on the centre of the set is calculated according to Table 36.

Bearing Arrangement	Suffix	S_a' N/ μm	K_{aE} $\alpha = 15^\circ$ and $\alpha = 25^\circ$ N
	DB	$S_a^{1)}$	$3 \cdot F_V$
	TBT	$1.64 \cdot S_a$	$6 \cdot F_V$
	QBC	$2 \cdot S_a$	$6 \cdot F_V$
	QBT	$2.24 \cdot S_a$	$9 \cdot F_V$
	PBC	$2.64 \cdot S_a$	$9 \cdot F_V$

K_{aE} = Unloading force F_V = Preloading force ¹⁾ Bearing tables

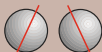
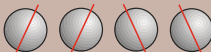
35: Axial rigidity S_a' of a bearing set at a centrically acting axial load

Bearing Arrangement	Suffix	S_r' N/ μm
	DB	S_r
	QBC	$2 \cdot S_r$
	TBT	$1.36 \cdot S_r$

36: Radial rigidity S_r' of a bearing set; the radial load acting on the centre of the set

Angular Contact Thrust Ball Bearings for Ball Screws 7602, 7603 and BSB

For bearing pairs in face-to-face or back-to-back arrangement, the axial rigidity S_a and the unloading forces K_{aE} can be obtained from the bearing tables. Sets of more than two bearings feature increased rigidity values. The values for the axial rigidity and unloading force that apply in such cases can be obtained from Table 37.

Double Direction Angular Contact Thrust Ball Bearings of Series 2344 and 2347

$$\delta_a = F_a / S_a$$

δ_a = axial deflection [μm]

F_a = axial load [N]





S_a = axial rigidity [$\text{N}/\mu\text{m}$]

The values S_a (see bearing tables) are valid up to an axial load corresponding to 2.2 % of the dynamic load rating C.

Axial-Radial Cylindrical Roller Bearings RTC

The values S_a , S_r and S_k in the bearing tables relate exclusively to the elastic deformation at the contact points of the rollers while the values S_{a1} and S_{k1} also consider the deformation of the centre disk and the bolts.

The latter values can be increased by bolting the arrangement to rigid counterpieces.

Bearing Arrangement	S_a' N/ μm	K_{aE}' N
	$S_a^{1)}$	$K_{aE}^{1)}$
	$2 \cdot S_a$	$2 \cdot K_{aE}$
	$3 \cdot S_a$	$3 \cdot K_{aE}$
	$4 \cdot S_a$	$4 \cdot K_{aE}$

¹⁾ Bearing tables

37: Axial rigidity S_a' and unloading force K_{aE}' of a bearing set at centrally acting axial load

The values for the tilting rigidity are based on medium axial and radial preload.

HANDLING OF SUPER PRECISION BEARINGS

Mounting

Handling of Super Precision Bearings

FAG super precision bearings are manufactured in clean surroundings, undergo intensive inspections and are packaged with great care. In order to preserve the full performance capacity of the bearings, they have to be handled carefully during mounting. A separate, clean mounting room offers the best conditions here. Mounting can be subdivided into the following steps:

Preparation of Parts

Only approved parts should be used for mounting. Depending on the component, the approval procedure consists of a dimensional inspection, optical inspection or an additional pre-balancing procedure.

Calibration of Parts

Fits have a decisive influence on bearing function. Therefore it is sometimes advisable to calibrate bearings to the spindle or housing diameter. In the case of spindle bearings the bore and housing tolerances are divided into groups, the mean tolerance of which is indicated on the packaging and the bearing itself. The spindle bearing width as a deviation of the nominal dimension is also indicated on the bearing (see "Bearing Code", page 176).

Matching Procedures

In order to obtain optimum performance or achieve an accurate position of the spindle in relation to the housing, it may be necessary to make special adjustments. This applies for instance to the cover that serves for axially clamping the

bearings in the housing. Prior to clamping the bearing should feature an adequate gap (Illustration 38).

An adjustment of spacers is advisable for high-speed spindles, so as e.g. to compensate for the influence of fit and ring expansion on preload.

Lubricating Greases

FAG super precision bearings are preserved in such a way that the washing of bearing prior to greasing is not required. The grease filling can be obtained from Tables 24 and 25 (page 136f). Precise grease quantities and a good distribution of the grease in the bearing can be achieved in a simple way by using a syringe.

Mounting

When mounting the bearing onto the shaft or inside the housing, forces must under no circumstances be borne by the rolling elements. Components that have to be mounted with tight fits (interference fits) should be heated prior to mounting. This can be done in a simple, quick and clean way by using inductive heating devices. Values for the axial clamping of bear-

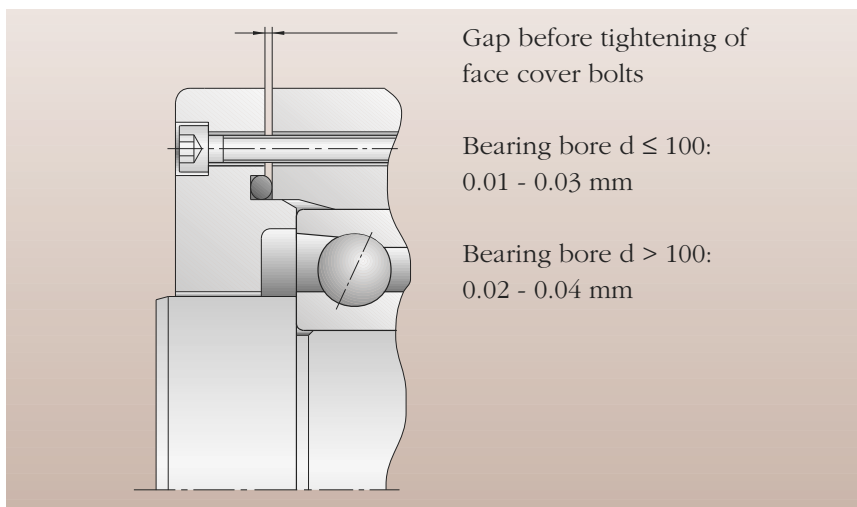

38: Recommended adjustment of face covers

39: Preloading forces and corresponding nut tightening torques for spindle bearing inner rings (opposite page)

Mounting

Bore/Bore Reference Number	Clamping Force				Tightening Torque				Thread
	718 kN	719	70	72	718 Nm	719	70	72	
6			0.16				0.13		M6x0.5
7			0.26				0.25		M7x0.5
8			0.29				0.32		M8x0.75
9			0.31				0.40		M9x0.75
00	0.17	0.34	0.55	0.48	0.24	0.48	0.78	0.68	M10x0.75
01	0.20	0.40	0.77	0.55	0.33	0.67	1.3	0.93	M12x1
02	0.24	0.48	0.77	0.66	0.51	1.0	1.6	1.4	M15x1
03	0.27	0.54	0.86	1.1	0.64	1.3	2.1	2.6	M17x1
04	0.56	0.99	1.0	1.2	1.6	2.8	2.9	3.3	M20x1
05	0.69	1.2	1.3	1.4	2.4	4.2	4.4	4.9	M25x1.5
06	0.82	1.4	1.4	2.2	3.4	6.0	5.7	9.4	M30x1.5
07	0.94	1.7	1.6	3.1	4.6	8.3	7.6	15	M35x1.5
08	1.1	1.9	1.8	2.8	6.0	11	9.8	15	M40x1.5
09	0.8	1.9	2.0	2.6	5.3	12	12	17	M45x1.5
10	1.8	2.1	2.2	2.4	12	15	15	17	M50x1.5
11	2.1	1.0	2.7	2.6	16	8	21	20	M55x2
12	2.0	1.1	2.9	4.4	17	9	24	37	M60x2
13	2.1	1.2	3.1	6.0	19	11	28	54	M65x2
14	2.2	2.5	3.3	5.7	22	24	33	56	M70x2
15	2.4	2.6	3.5	6.1	25	28	37	64	M75x2
16	2.5	2.8	5.1	5.6	29	31	58	63	M80x2
17	2.0	4.0	5.4	8.2	24	47	65	98	M85x2
18	2.2	4.2	8.7	10	27	53	110	130	M90x2
19	2.3	4.4	7.6	12	30	59	101	163	M95x2
20	2.4	4.6	7.9	11	34	65	111	154	M100x2
21	2.5	4.9	6.3	13	37	72	92	197	M105x2
22	4.3	5.1	6.6	16	66	78	101	246	M110x2
24	4.7	7.5	7.1	25	78	126	119	418	M120x2
26	5.3	6.5	9.9	16	96	118	180	289	M130x2
28	5.7	7.0	11	30	111	136	207	580	M140x2
30	8.1	6.2	12	45	170	131	254	951	M150x2
32	8.6	6.6	16	57	193	148	349	1274	M160x3
34	12	7.0	19	63	284	167	462	1493	M170x3
36	13	13	24	61	318	338	593	1534	M180x3
38	15	14	25	64	391	376	659	1699	M190x3
40	15	19	29	85	432	539	823	2391	M200x3
44	17	21	30	115	521	648	910	3557	Tr220x4
48	22	23	36		731	769	1214		Tr240x4
52		42				1530			Tr260x4
56		45				1769			Tr280x4
60		52				2194			Tr300x4
64		56				2488			Tr320x5
68		59				2801			Tr340x5
72		62				3132			Tr360x5

Values correspond to a side face pressure of ≈ 10 MPa.

HANDLING OF SUPER PRECISION BEARINGS

Mounting • Special Super Precision Bearing Training

ings on the shaft by means of a precision nut are indicated in Table 39 (see page 175). To rule out or reduce setting effects, it is recommended to initially tighten the nut with three times the indicated torque, loosen it again and then tighten it with the nominal torque.

Clearance Adjustment in Cylindrical Roller Bearings

Cylindrical roller bearings with tapered bore are mounted with clearance, zero-clearance or preload. This can be done to the precision of $\pm 1 \mu\text{m}$ with the help of an FAG boundary circle measuring device. If such a measuring device is not available, a fairly exact clearance adjustment can be achieved by measuring the axial drive-up distance of the inner ring onto the tapered shaft seating, **taper 1:12**. This drive-up distance is **15 times** larger than the radial expansion effected in this way. Surface smoothing and the elastic behaviour of the spindle and the inner ring also make their contribution here. When mounting cylindrical roller bearings, score marks can be safely avoided if the inner ring is if possible not tilted relative to the outer ring and the spindle is turned continually. Here, too, heating the housing and the outer ring facilitates the mounting procedure.

Test Run

With grease-lubricated bearings a special grease distribution procedure has to be carried out prior to a test run. Details on grease distribution can be obtained from Diagram 27 (see page 139).

Report

A quality assurance document is created by drawing up measuring reports during mounting and setting into operation. Important measuring values are for example:

- Seating diameter, interference
- Spacer difference dimensions
- Steady-state temperature
- Radial and axial runout

Special Super Precision Bearing Training

The handling of super precision bearings as well as various mounting and measuring devices requires a high degree of special expertise.

The performance capacity of super precision bearings can only be fully exploited when the appropriate bearing is selected and mounted in the correct way.

FAG AC/SP has made it its business to pass on the knowledge about the complicated processes in super precision bearings in specially conceived training programs. These offer differentiated training concepts that are optimally tailored to the concrete requirements of the respective target groups (master craftsmen, mounting operators, engineers, commercial staff).

The training units deal with the improvement of existing designs by using high-performance, innovative products. In addition, they also introduce the latest newly developed products.

The orientation of each specific subject is kept as practical as possible. In addition to the required basic knowledge about function and application of super precision bearings, assembly technicians are invited to make themselves familiar with the handling of mounting devices and measuring instruments under expert direction in FAG workshops. As a rule, the training programs include the following contents:

Special Super Precision Bearing Training

Training courses for master craftsmen and mounting operators of machine tool users and manufacturers

- Theoretical basics:
 - bearing types, designs and performance feature of FAG super precision bearings
 - the special quality of machine tool bearing arrangements and their effects on mounting
 - lubrication of rolling bearings and rolling bearing damage
 - bearing monitoring during operation

- Practical handling:
Mounting of machine tool bearing arrangements and use of special measuring devices, e.g.:
 - boundary circle measuring devices
 - taper measuring instruments
 - induction heating devices

- Bearing monitoring, e.g.:
- temperature monitoring
 - vibration monitoring
 - friction torque monitoring

- Failure analysis, e.g.:
- assessment of mating surfaces
 - assessment of lubrication conditions

Training courses for engineers in design or distribution

- Engineers
 - computer calculation program *SpiCaS 2000*
 - influences in the bearing environment, fits, tolerances
 - specific features when mounting super precision bearings
 - lubrication
 - analysis of rolling bearing damage
 - bearing monitoring during operation
- Commercial staff
 - product range
 - bearing designations
 - basic super precision bearing knowledge



40: Heating of a precision bearing using induction heating device

SpiCaS 2000

***SpiCaS 2000* – the PC Program for Selection and Application of FAG Super Precision Bearings**

With *SpiCaS 2000* it is possible to calculate operating influences including fits, temperature, speeds or loads on bearing performance quickly and with ease. When using this spindle bearing calculation program right at the design stage, lengthy subsequent examinations can be avoided. *SpiCaS 2000* renders significant time advantages and delivers reliable bearing arrangements.

The program includes all products featured in this catalogue.

It offers:

- drawings true to scale
- selection possibilities for bearings according to
 - bearing type
 - external dimensions
 - attainable speed
 - load ratings
- mounting sketches with indication of abutment dimensions
- recommendations for speed-dependent mounting fits
- influences on preload in spindle bearings through speeds, fits and temperature
- kinematic bearing frequencies for vibration analyses
- calculation of bearing life according to the latest findings
- lubricant service life
- critical speed (relative to shaft deflection)
- shaft deflection
- further useful information

SpiCaS 2000 can be operated on all 32 bit Windows operating systems.



41: *SpiCaS 2000* offers a familiar user interface and has English, German, Italian and French language options.

OTHER PRODUCTS

The world of FAG Super Precision Bearings



42: Barden Super Precision Ball Bearings – Specialty Products

At www.fag.de or www.fag.com, FAG products are easily available for calculations, drawings and other functional use, and there is more ...

This catalogue is available in English, German, Italian, French, Spanish, Chinese and Czech. It can also be obtained on CD-ROM.

FAG Precision Locknuts ensure safe and highly accurate positioning of the bearings on the shaft. Further information, for instance about the FAG spindle monitoring concept *SpiCoM* or our precision nuts, can be obtained from FAG Aerospace/Superprecision.

Other FAG super precision products are included in the catalogue “Barden Super Precision Ball Bearings – Specialty Products”. It is available from:

The Barden Corporation (UK)
Plymbridge Road, Estover,
Plymouth PL6 7LH, Devon
Tel.: +44(0) 17 52-73 55 55
Fax: +44(0) 17 52-73 34 81
e-mail: sales@barden.co.uk



43: www.fag.com - Bearing data and calculation possibilities



44: FAG catalogue “Precision Technology Inside” on CD-ROM



45: FAG Precision Locknuts

SPINDLE BEARINGS

The diagram shows a cross-section of a FAG spindle bearing with various markings. Red lines connect these markings to a list of descriptions on the left:

- 01: Calendar week of production
- S: Year of production
- B: Place of production
- GERMANY: Country of origin
- X30: Special material for inner ring (here: Cronidur 30)
- <-3 / -100>: Reference number for actual outside diameter and deviation from nominal bearing width
- FAG: Trademark
- XCB1008E: Mark for largest wall thickness of inner ring
- T.PAS: Design designation
- UL: Special material for outer ring
- X30: Special material for outer ring

The complete bearing part number is marked on the inner ring with sealed B-type spindle bearings (.RSD). The calibration number have following order <bore/outer diameter/Deviation from nominal bearing width> for example <-1/-3/-100>

46: Designation details of FAG spindle bearings

SPINDLE BEARINGS

Contact Angle Marks on Single Bearings

The position of the contact angle is marked by an arrow on the bearing outer circumference. The open side of the arrow faces the outer ring lip end.

Designation and Marking of Bearing Sets

Bearing sets consist of bearings with matched bore and outside diameters. The first letter refers to the number of bearings in a set.

- D 2 bearings Duplex
- T 3 bearings Triplex
- Q 4 bearings Quadruplex

Ready-to-mount bearing sets feature a defined order of bearings. The second and third letters refer to the preloading of the bearings within the set:

- B back-to-back arrangement
- F face-to-face arrangement
- T tandem arrangement
- BT back-to-back arrangement against a tandem set of 2 or 3 bearings
- FT face-to-face arrangement against a tandem set of 2 or 3 bearings

In ready-to-mount bearing sets the overall large arrow indicates the position of the bearing within the set. The load direction (contact angle position) is indicated through the small arrow symbol at the circumference of the single bearing.

In universal bearing sets the second letter of the set designation is a U. Bearings of universal sets can be mounted in any arrangement without suffering performance losses. Therefore universal bearing sets feature no mounting position marks at the circumference except for their contact angle marks.

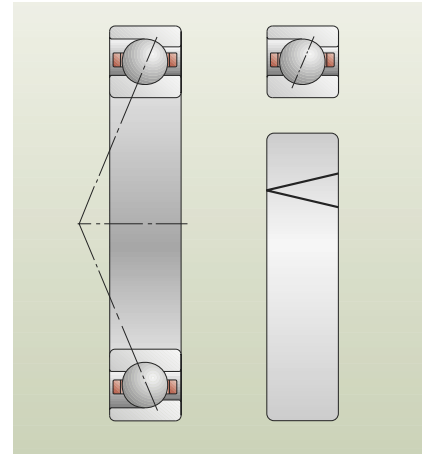

47: Contact angle marks on a single bearing

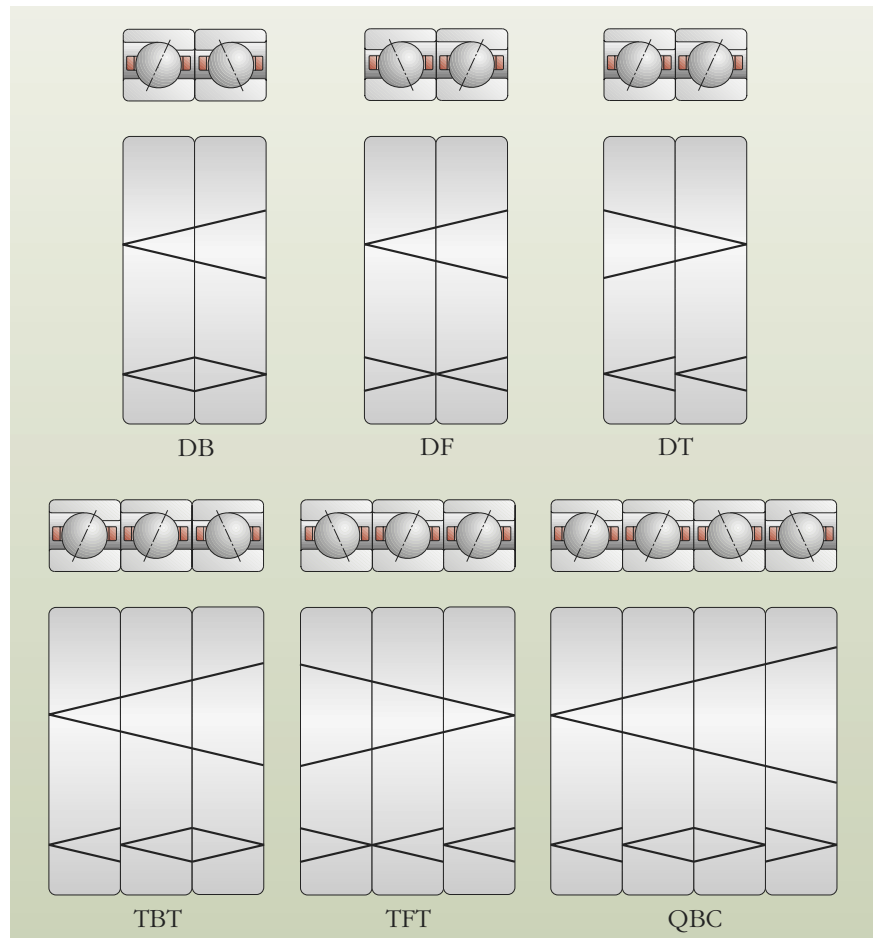

48: Examples of ready-to-mount bearing sets

BEARING CODE SPINDLE BEARINGS

B 70 08 C .T.P4S.UL
 HSS 70 08 C .T.P4S.UL
 HCB 70 08 C DLR.T.P4S.UL
 B 70 08 C .2RSD.T.P4S.UL
 B 70 08 C .T.P4S.UL.L75

Bearing Type

B	Standard Steel balls
HCB	Hybrid standard Ceramic balls
XCB	X-life ultra Ceramic balls
HS	High-speed bearing Steel balls
HSS	High-speed bearing Steel balls, sealed
HC	High-speed bearing Ceramic balls
HCS	High-speed bearing Ceramic balls, sealed
XC	X-life ultra High-speed bearings Ceramic balls
XCS	X-life ultra High-speed bearings Ceramic balls, sealed

Dimension Series

718	Ultra-light series
719	Lightweight series
70	Medium series
72	Heavy series

Bore Reference Number

6	6 mm
7	7 mm
8	8 mm
9	9 mm
00	10 mm
01	12 mm
02	15 mm
03	17 mm
04	4 · 5 = 20 mm
05	5 · 5 = 25 mm

Contact Angle

C	15°
E	25°

External Form

DLR	DIRECT LUBE Direct lubrication via integral O-rings
------------	---

Sealing

.2RSD	Seals at both sides and greased Sealed designs are marked with a point (•) in the bearing tables
--------------	--



Grease Filling by Manufacturer

L75	FAG grease Arcanol L75 for non-sealed bearings Bearings with seals at both sides are lubricated for life with L75
------------	---

Preload

L	Light
M	Medium
H	Heavy

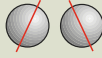
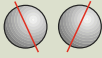
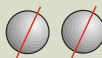
Bearing Arrangement

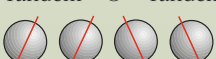
U	Single bearing Any arrangement
DU	Set of 2 universal bearings
TU	Set of 3 universal bearings
QU	Set of 4 universal bearings
PU	Set of 5 universal bearings
DB	Set of 2 bearings Back-to-back arrangement 
DF	Set of 2 bearings Face-to-face arrangement 
DT	Set of 2 bearings Tandem arrangement 
TBT	Set of 3 bearings Tandem – O – arrangement 
QBC	Set of 4 bearings Tandem – O – Tandem arrangement. 

Accuracy

P4S	FAG standard
------------	--------------

Cage

T	Textile laminated phenolic resin Outer ring centred
TPA	Textile laminated phenolic resin Series B718 Outer ring centred

**BEARING CODE
SPINDLE BEARINGS**







BEARING CODE FLOATING DISPLACEMENT BEARINGS

FD 10 10 T.P4S
FD 10 10 K.T.P4S
FD 10 10 DLR.T.P4S
FD 10 10 .2RSD.T.P4S

Bearing Type

FD Floating Displacement bearing
Ceramic balls

Dimension Series

10 Medium series

Bore Reference Number

- 00** 10 mm
- 01** 12 mm
- 02** 15 mm
- 03** 17 mm
- 04** 4 · 5 = 20 mm
- 05** 5 · 5 = 25 mm

External Form

DLR DIRECT LUBE
Direct lubrication via
integral O-rings

Accuracy

P4S FAG standard

Cage

T Textile laminated phenolic resin
Outer ring centred

Tapered Bore

K Tapered bore (taper 1:12)

Sealing

.2RSD Seals at both sides and greased
"for life"

BEARING CODE
FLOATING DISPLACEMENT BEARINGS







BEARING CODE SUPER PRECISION CYLINDRICAL ROLLER BEARINGS

N 10 20 K .M1 .SP
HCN 10 20 K .M1 .SP
N 19 20 K .M1 .SP .C2

Bearing Type

- N** Cylindrical roller bearing, single row
Lips on inner ring
Outer ring lipless
- HCN** Cylindrical roller bearing, single row
Ceramic rollers
Lips on inner ring
Outer ring lipless

Dimension Series

- 19** Light series
- 10** Medium series

Bore Reference Number

- 06** $6 \cdot 5 = 30$ mm
- 08** $8 \cdot 5 = 40$ mm

Radial Clearance

- C2** Radial clearance according to specification, > C1
- R40.50** Individual radial clearance
Accuracy SP and UP feature
C1NA radial clearance as standard

Accuracy

- SP** Special Precision
- UP** Ultra Precision

Cage

- M1** Brass cage, roller-centred

Tapered Bore

- K** Tapered bore (taper 1:12)

NNU 49 20 SK .M .SP
NN 30 20 ASK .M .SP
NN 30 20 ASK .M .SP .C2

Bearing Type

- NNU** Cylindrical roller bearing, double row
Lips on outer ring
Inner ring lipless
- NN** Cylindrical roller bearing, double row
Lips on inner ring
Outer ring lipless

Dimension Series

- 49** Light series
- 30** Medium series

Bore Reference Number

- 06** $6 \cdot 5 = 30$ mm
- 08** $8 \cdot 5 = 40$ mm

Radial Clearance

- C2** Radial clearance according to specification, > C1
- R40.50** Individual radial clearance
Accuracy SP and UP feature
C1NA radial clearance as standard

Accuracy

- SP** Special Precision
- UP** Ultra Precision

Cage

- M** Brass cage, roller-centred

Tapered Bore

- K** Tapered bore (taper 1:12)

External Form

- S** Lubricating groove and holes on the outer ring
- AS** Lubricating groove and holes on the outer ring
Series NN30

BEARING CODE
SUPER PRECISION CYLINDRICAL ROLLER BEARINGS







BEARING CODE

DOUBLE DIRECTION ANGULAR CONTACT THRUST BALL BEARINGS

2344 24 M .SP

Series designation

2344 For mounting at small-end taper
2347 For mounting at large-end taper

Accuracy

SP Special Precision
UP Ultra Precision

Bore Reference Number

06 $6 \cdot 5 = 30$ mm
10 $10 \cdot 5 = 50$ mm

Cage

M Brass cage

BEARING CODE
DOUBLE DIRECTION ANGULAR CONTACT THRUST BALL BEARINGS







BEARING CODE

ANGULAR CONTACT THRUST BALL BEARINGS FOR BALL SCREWS

76 02 035 .TVP
 BSB 035 072 .T .D .L55
 76 02 035 .2RS .TVP
 BSB 035 072 .2RS .T

Bearing Type

76 Angular contact thrust ball bearing
BSB Angular contact thrust ball bearing

Dimension Series

02 ISO diameter series 2
03 ISO diameter series 3

Bore Diameter

Dimensions in mm

Outside Diameter

Dimensions in mm

Sealing

.2RS Sealed at both sides and greased

Cage

TVP PA66-GF25 polyamide cage, ball-centred
T PA66-GF25 polyamide cage, ball-centred

Grease Filling by Manufacturer

L55 FAG grease Arcanol L55 for non-sealed bearings
 Bearings with seals at both sides are lubricated for life with L55

Preload

Universal bearing without suffix
 Single bearing any arrangement

Bearing Arrangement

D Set of 2 universal bearings
T Set of 3 universal bearings
Q Set of 4 universal bearings
P Set of 5 universal bearings
DB Set of 2 bearings, back-to-back arrangement

BEARING CODE
ANGULAR CONTACT THRUST BALL BEARINGS FOR BALL SCREWS





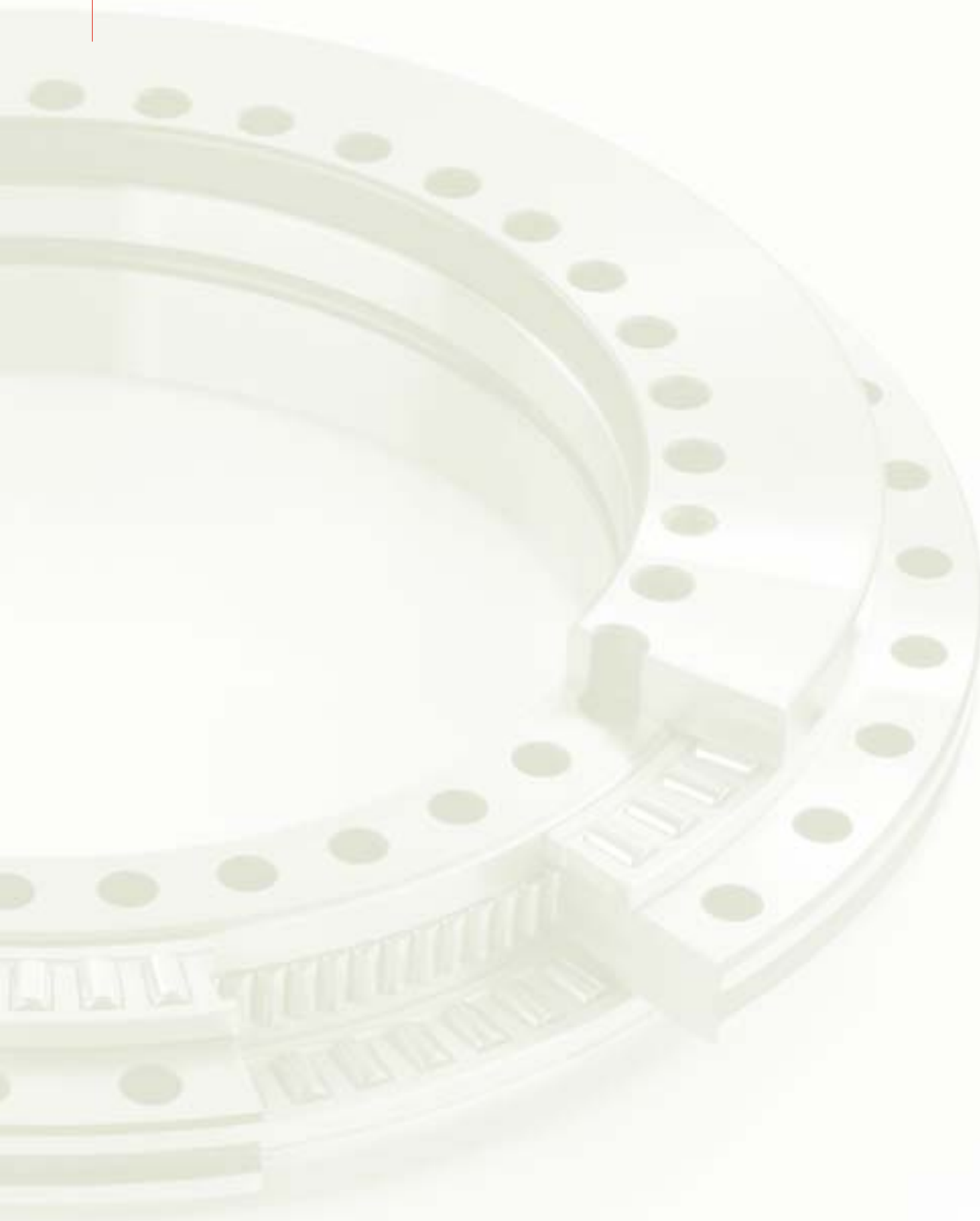

BEARING CODE

AXIAL-RADIAL CYLINDRICAL ROLLER BEARINGS

RTC 260
RTC 260 .T52E

Bearing Type

RTC Axial-radial cylindrical roller bearing

Bore Diameter

Dimensions in mm

Specialty

T52E Increased accuracy
T52EA Increased accuracy,
axial preload 50 % reduced

BEARING CODE
AXIAL-RADIAL CYLINDRICAL ROLLER BEARINGS

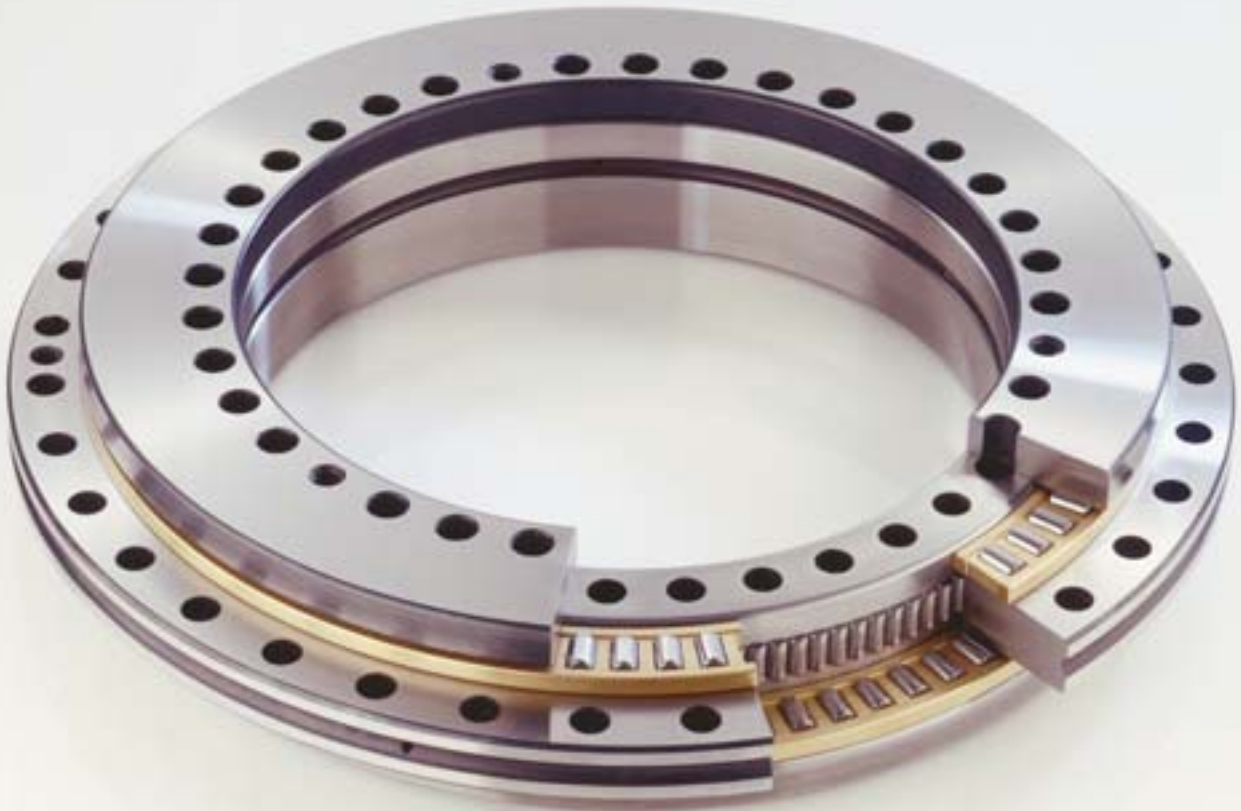

NOTES

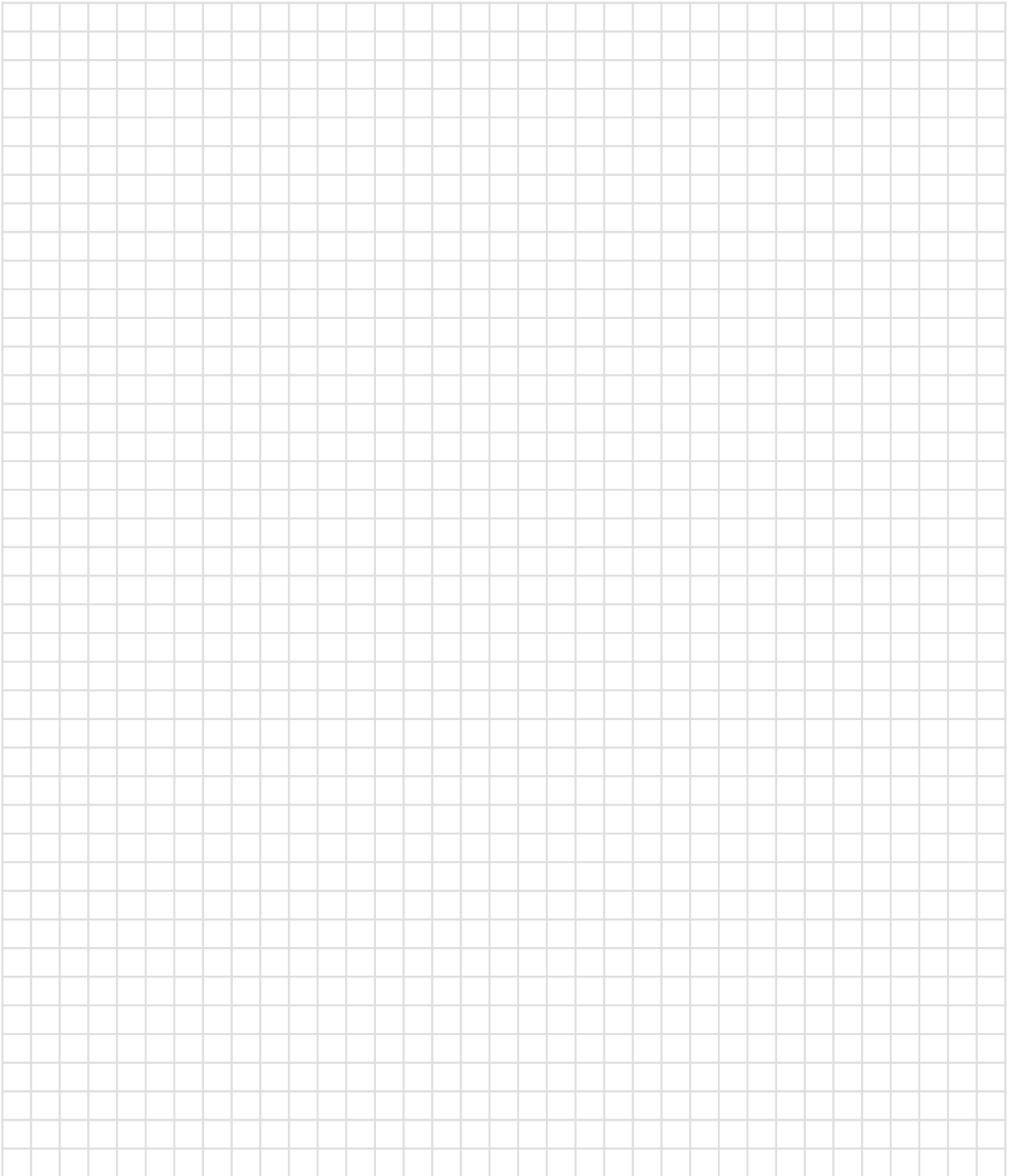

INDEX

Accuracy: 4, 6, 112, 120, 126, 142 ff, 168
Angular contact thrust ball bearings for ball screws: 112 ff, 127 f, 142, 150f, 162 f, 166, 169, 194
Axial-radial cylindrical roller bearings: 6, 120 ff, 127 ff, 136, 152 f, 163, 198 ff
Bearing code: 11, 113, 176 ff
Bearing sets: 8 f, 112 f, 168, 177
Clamping force: 171
Cronidur 30: 6, 11, 78
Cylindrical roller bearings, radial clearance: 78, 84, 149
Cylindrical roller bearings: 84 ff, 102, 128, 142, 146 ff, 159 f, 166 f, 171, 172, 186
Deflection: 168 ff, 172
Designation system (see Bearing code)
Direct Lube spindle bearings: 10, 25 ff, 141
Double direction angular contact thrust ball bearings: 84, 102 ff, 161, 169, 190
FD bearings: 78 ff, 127 f, 142, 144, 182
Floating bearings: 78, 84
Grease: 7, 9 f, 84, 103, 112 f, 121, 134 ff, 164, 170
Hybrid cylindrical roller bearings: 7, 84 ff
Hybrid spindle bearings: 7, 10, 11, 12 ff
Indexing table bearings (see Axial-radial cylindrical roller bearings)
Injection pitch circle: see Bearing tables (Etk), 141
Interference: 164 f
Life calculation: 129 ff, 174
Lubrication: 7, 9, 10, 103, 130, 134 ff, 164, 172
Machining tolerances: 154 ff
Mounting: 11, 120, 135, 167, 170 ff
Oil-air lubrication: 7, 84, 103, 141
Precision nuts: 170, 175
Preload: 7, 84 f, 102, 139, 164 ff
Rigidity: 7, 8, 84 f, 102, 112, 120, 126, 168 ff
Ring expansion: 164
RTC bearings (see Axial-radial cylindrical roller bearings)
Sealed bearing: 9, 12 ff, 112, 132, 135
Service life calculation: 126 ff, 174
Speeds: 4, 5, 7, 11, 78, 84, 120, 126, 128, 135, 139 f, 164 ff, 174
SpiCaS 2000: 127, 172 f
Spindle bearing sets (see Bearing sets)
Spindle bearings: 5, 8, 12 ff, 128, 144, 166, 168, 176 ff
Tolerances for super precision bearings: 4, 11, 102, 112, 142 ff
Universal bearings: 8, 112 f, 177
X-life ultra: 5, 11, 12 ff

Every care has been taken to ensure the accuracy of the information contained in this catalogue. Yet no liability can be accepted for any errors or omissions. We reserve the right to make any changes necessitated by technological progress.

This publication is a technical catalogue; it does not consider availability or possible minimum order quantities of products listed.

© by FAG 2003. The contents of this publication (even extracts) may not be reproduced unless permission is granted.

Printed in Germany by Weppert GmbH & Co. KG, Schweinfurt.

AC 41 130/5 EA/97.5/4/03



FAG Kugelfischer AG & Co. KG

Aerospace/Superprecision

Georg-Schäfer-Str. 30 • D-97421 Schweinfurt
Tel +49 (0) 97 21 / 91 19 11 • Fax +49 (0) 97 21 / 91 36 66
E-Mail: acsp@fag.de • www.fag.com

The Barden Corporation

P.O.Box 2449 • 200 Park Avenue
Danbury, Connecticut 06813-2449
Phone 203 / 744 - 2211 • Fax 203 / 744 - 3756
E-Mail: sales@bardenbearings.com • www.bardenbearings.com

The Barden Corporation (UK)

Plymbridge Road • Estover
Plymouth PL6 7LH • Devon
Phone +44 (0) 17 52 / 73 55 55 • Fax +44 (0) 17 52 / 73 34 81
E-Mail: sales@barden.co.uk • www.barden.co.uk

FAG Kugelfischer AG & Co. KG

Aerospace/Superprecision